

D4 miniature switch



Technical specifications

Contact configuration	S.P.D.T., S.P.S.T. - N.O., S.P.S.T. - N.C
Contact gap	< 3 mm (μ)
Switching voltage	250 VAC (400 V on request)
Switched current max.	< 0,1 to 21 A, depending on model
Total travel	2,6 mm
Mechanical life	see table
Electrical life	see table
Ambient temperature	40T85; 40T125; 40T150
Proof tracking index	PTI 300
Materials	
Housing/cover	PET (UL94 V-0)
Actuator	POM (max. 85°C) alternative PET (UL94 V-0)
Contacts	D41 AuAgPt (Crosspoint) D42 Ag D43 - D48 AgNi
Terminals	CuZn alternative Cu
Auxiliary actuator	nickel-plated steel, alternative stainless steel
Approvals	
Degree of protection (switch interior)	IP40

For detailed information and the layout of the details described above, please do not hesitate to ask for our technical specifications and drawing.

Features

Mounting holes

Hole dimensions	Measurement „A“	Measurement “B”
Global version	3,1 +0,15 mm	3,3 +0,15 mm

Dimensions in mm

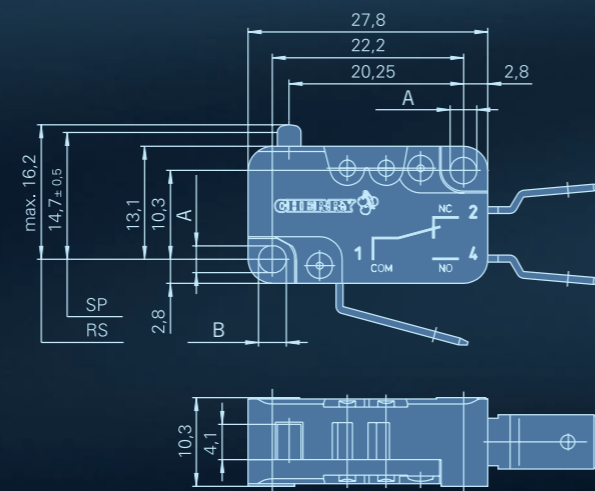

Terminals

Q.C. terminal, 6,3x0,8 mm, straight
V1

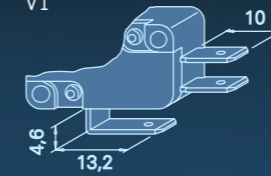

Q.C. terminal, 6,3x0,8 mm, dog-leg
V3

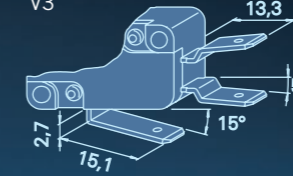

Solder terminal, short
B8



Solder terminal with temperature-stop
S1

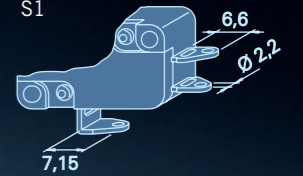

Q.C. terminal 4,8x0,8 mm straight
Q1

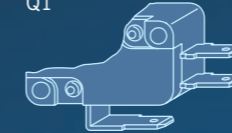

Q.C. terminal, 4,8x0,8 mm dog-leg
Q3

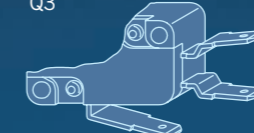

PCB terminal 1,3x0,8 mm housing side
PA



PCB terminal 1,3x0,8 mm cover side
PB



Q.C. terminal RAST 2,5
X5



Q.C. terminal 4,8x0,5 mm dog-leg
R3



PCB terminal 1,3x0,5 mm underside
P4

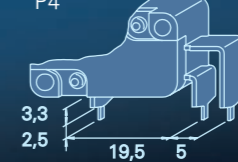

PCB terminal 1,3x0,8 mm rear
P5



Q.C. terminal 6,3x0,8 mm RAST 5
Y5



Q.C. terminal 2,8x0,8 mm bifurcated dog-leg
C3



Connector housing for Q.C. terminals RAST 5



Q.C. terminal, 4,8x0,5 mm, straight
R1



Other terminals available on request.

Drilling patterns for PCB terminals

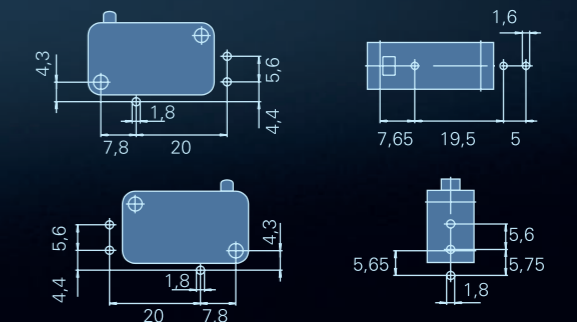



D4 miniature switch

Electrical rating and operating life

Electrical rating according to		Electrical life for 40T85*		Mechanical lifetime actuator material		Max. operating force (cN)	Housing mark
EN 61058-1	UL 1054	acc. to EN	acc. to UL	POM	PET		
Standard operating force							
0,1 (0,05) A, 250 VAC	0,1 A 125–250 VAC	50.000	6.000	10x10 ⁶	1x10 ⁶	170	D4 1 Y
3 (1) A, 250 VAC	3 A, 125–250 VAC 1/10 HP 250 VAC	50.000	6.000	10x10 ⁶	1x10 ⁶	170	D4 2 Y
6 (2) A, 250 VAC	5 A, 125–250 VAC, 1/4 HP 250 VAC	50.000	6.000	5x10 ⁶	25x10 ⁴	170	D4 3 Y
10 (3) A, 250 VAC	10 A, 1/2 HP, 125–250 VAC	50.000	6.000	1x10 ⁶	1x10 ⁵	285	D4 4 Y
16 (4) A, 250 VAC	15 A, 1/2 HP, 125–250 VAC	50.000	6.000	2x10 ⁵	1x10 ⁵	400	D4 5 Y
10 (3) A, 400 VAC							
Light operating force							
0,1 (0,05) A, 250 VAC	0,1 A, 125–250 VAC	50.000	6.000	10x10 ⁶	1x10 ⁶	45**	D4 1 X
3 (1) A, 250 VAC	3 A, 125–250 VAC, 1/10 HP 250 VAC	50.000	6.000	10x10 ⁶	1x10 ⁶	45**	D4 2 X
6 (2) A, 250 VAC	5 A, 125–250 VAC, 1/4 HP 250 VAC	50.000	6.000	10x10 ⁶	5x10 ⁵	45	D4 3 X
10 (3) A, 250 VAC	10 A, 1/2 HP, 125–250 VAC	50.000	6.000	10x10 ⁶	25x10 ⁴	75	D4 4 X
16 (4) A, 250 VAC	15 A, 1/2 HP, 125–250 VAC	50.000	6.000	10x10 ⁶	25x10 ⁴	100	D4 5 X
21 (8) A, 250 VAC	21 A, 250 VAC 1HP 125 VAC 2HP 250 VAC	10.000	6.000	3x10 ⁶	25x10 ⁴	150	D4 8 X

* Operating life for 40T125 and 40T150 on request
 ** Lower operating forces and additional electrical ratings on request

Switching parameters

Model	Type	Max. operating force (cN)		Max. pretravel (mm)	Min. overtravel (mm)	Differential travel max. (mm)	Max. rest position (mm)	Operating point (mm)
		Standard	Light					
Without auxiliary actuator	D41	170	45	1,2	1,3	0,3	16,2	14,7 ± 0,5
	D42	170	45	1,2	1,3	0,3	16,2	14,7 ± 0,5
	D43	170	45	1,2	1,3	0,3	16,2	14,7 ± 0,5
	D44	285	75	1,2	1,3	0,3	16,2	14,7 ± 0,5
	D45	400	100	1,2	1,3	0,3	16,2	14,7 ± 0,5
	D48	–	150	1,6	1,2	0,3	16,2	14,7 ± 0,5

Preferred parts

Type	Order code	Electrical rating		Terminals	Auxiliary actuator	Operating force (cN)	Operating point (mm)	Max. pretravel (mm)	Min. overtravel (mm)	Differential travel max. (mm)
		EN	UL							
US mounting holes	D41C-R1AA*	0.1(0.05)A, 250V~	0,1 A, 125/250 VAC	Q.C. terminals 4,8x0,5mm, straight	–	170	14,7 ± 0,5	1,2	1,3	0,3
	D41C-R1LD*	0.1(0.05)A, 250V~	0,1 A, 125/250 VAC	Q.C. terminals 4,8x0,5mm, straight	Straight RM rear, length 35,6mm	86	15,3 ± 1,2	3,2	2,2	0,8
	D42L-R1ML	3(1)A, 250V~	3 A, 125/250 VAC 1/10HP, 250VAC	Q.C. terminals 4,8x0,5mm, straight	Straight FM front, length 74,5mm	6	15,2 ± 4,2	12,7	7,9	2,5
	D44L-R1AA	10(3)A, 250V~	10 A, 1/2HP, 125/250 VAC	Q.C. terminals 4,8x0,5mm, straight	–	75	14,7 ± 0,5	1,2	1,3	0,3
	D44L-R1LD	10(3)A, 250V~	10 A, 1/2HP, 125/250 VAC	Q.C. terminals 4,8x0,5mm, straight	Straight RM rear, length 35,6mm	40	15,3 ± 1,2	3,2	2,2	0,8
	D44L-R1RA	10(3)A, 250V~	10 A, 1/2HP, 125/250 VAC	Q.C. terminals 4,8x0,5mm, straight	Roller RM rear, length 20,6 mm	75	20,5 ± 0,8	1,2	1,0	0,3
	D45L-R1LL	16(4)A, 250V~	15 A, 1/2HP, 125/250 VAC	Q.C. terminals 4,8x0,5mm, straight	Straight RM rear, length 69,9mm	22	15,2 ± 3,2	7,6	4,7	1,7
	D419-V3AA	0.1(0.05)A, 250V~	0,1 A, 125/250 VAC	Q.C. terminals 6,3x0,8mm, dog-leg	–	45	14,7 ± 0,5	1,2	1,3	0,3
	D429-V1AA	3(1)A, 250V~	3 A, 125/250 VAC 1/10HP, 250VAC	Q.C. terminals 6,3x0,8mm, straight	–	45	14,7 ± 0,5	1,2	1,3	0,3
	D449-V1AA	10(3)A, 250V~	10 A, 1/2HP, 125/250 VAC	Q.C. terminals 6,3x0,8mm, straight	–	75	14,7 ± 0,5	1,2	1,3	0,3
International mounting holes	D459-B8AA	16(4)A, 250V~	15 A, 1/2HP, 125/250 VAC	Solder terminals, short	–	100	14,7 ± 0,5	1,2	1,3	0,3
	D459-V3AA	16(4)A, 250V~	15 A, 1/2HP, 125/250 VAC	Q.C. terminals 6,3x0,8mm, dog-leg	–	100	14,7 ± 0,5	1,2	1,3	0,3
	D459-V3LD	16(4)A, 250V~	15 A, 1/2HP, 125/250 VAC	Q.C. terminals 6,3x0,8mm, dog-leg	Straight RM rear, length 35,6mm	40	15,3 ± 1,2	3,2	2,2	0,8
	D489-V3AA	16(4)A, 250V~	15 A, 1/2HP, 125/250 VAC	Q.C. terminals 6,3x0,8mm, dog-leg	–	150	14,2 ± 0,5	1,8	0,9	0,3

* Versions with standard operating force; other versions with operating force light

Auxiliary actuator options

Model	Mounting point	Length (mm)	
Straight	RM rear	21,2 35,6 69,9	
	FM front	25,7 40,1 74,4	
	Roller	RM rear	20,6 34,1
		FM front	25,1 38,6
Simulated Roller	RM rear	20,6	
	FM front	25,1	

