

# FMS7G20US60

## Compact & Complex Module

### Features

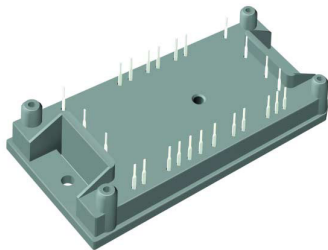
- Short Circuit rated  $10\mu\text{s}$  @  $T_C = 100^\circ\text{C}$ ,  $V_{GE} = 15\text{V}$
- High Speed Switching
- Low Saturation Voltage :  $V_{CE(sat)} = 2.1\text{V}$  @  $I_C = 20\text{A}$
- High Input Impedance
- Built in Brake & 3 Phase Rectifier Circuit
- Fast & Soft Anti-Parallel FWD
- Built-in NTC Thermistor

### Applications

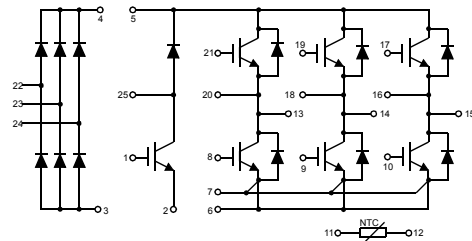
- AC & DC Motor Controls
- General Purpose Inverters
- Robotics
- Servo Controls

### Description

Fairchild IGBT Power Module provides low conduction and switching losses as well as short circuit ruggedness. It's designed for the applications such as motor control and general inverters where short-circuit ruggedness is required.



Package Code : 25PM-AA



Internal Circuit Diagram

## Absolute Maximum Ratings T<sub>C</sub> = 25°C unless otherwise noted

	Symbol	Description	FMS7G20US60	Units
Inverter & Brake	V <sub>CES</sub>	Collector-Emitter Voltage	600	V
	V <sub>GES</sub>	Gate-Emitter Voltage	± 20	V
	I <sub>C</sub>	Collector Current @ T <sub>C</sub> = 80°C	20	A
	I <sub>CM(1)</sub>	Pulsed Collector Current	40	A
	I <sub>F</sub>	Diode Continuous Forward Current @ T <sub>C</sub> = 80°C	20	A
	I <sub>FM</sub>	Diode Maximum Forward Current	40	A
	P <sub>D</sub>	Maximum Power Dissipation @ T <sub>C</sub> = 25°C	89	W
	T <sub>SC</sub>	Short Circuit Withstand Time @ T <sub>C</sub> = 100°C	10	µs
Converter	V <sub>RRM</sub>	Repetitive Peak Reverse Voltage	1600	V
	I <sub>O</sub>	Average Output Rectified Current	20	A
	I <sub>FSM</sub>	Surge Forward Current @ 1Cycle at 60Hz, Peak value Non-Repetitive	200	A
	i <sup>2</sup> t	Energy pulse @ 1Cycle at 60Hz	164	A <sup>2</sup> s
Common	T <sub>J</sub>	Operating Junction Temperature	-40 to +150	°C
	T <sub>STG</sub>	Storage Temperature Range	-40 to +125	°C
	V <sub>ISO</sub>	Isolation Voltage @ AC 1minute	2500	V
Mounting Torque	Mounting part Screw @ M4	2.0	N·m	

**Notes :**

(1) Repetitive rating : Pulse width limited by max. junction temperature

## Package Marking and Ordering Information

Device Marking	Device	Package	Reel Size	Tape Width	Quantity
FMS7G20US60	FMS7G20US60	25PM-AA	--	--	--

(2) TMC2 Reliability test was done under -45°C ~ 125°C

**Electrical Characteristics of IGBT @ Inverter**  $T_C = 25^\circ\text{C}$  unless otherwise noted

Symbol	Parameter	Test Conditions	Min.	Typ.	Max.	Units
<b>Off Characteristics</b>						
$BV_{CES}$	Collector-Emitter Breakdown Voltage	$V_{GE} = 0V, I_C = 250\mu A$	600	--	--	V
$\frac{\Delta BV_{CES}}{\Delta T_J}$	Temperature Coeff. of Breakdown Voltage	$V_{GE} = 0V, I_C = 1mA$	--	0.6	--	V/ $^\circ\text{C}$
$I_{CES}$	Collector Cut-Off Current	$V_{CE} = V_{CES}, V_{GE} = 0V$	--	--	250	$\mu A$
$I_{GES}$	Gate - Emitter Leakage Current	$V_{GE} = V_{GES}, V_{CE} = 0V$	--	--	$\pm 100$	nA
<b>On Characteristics</b>						
$V_{GE(th)}$	Gate - Emitter Threshold Voltage	$I_C = 20mA, V_{CE} = V_{GE}$	5.0	6.5	8.5	V
$V_{CE(sat)}$	Collector to Emitter Saturation Voltage	$I_C = 20A, V_{GE} = 15V$	--	2.1	2.7	V
<b>Dynamic Characteristics</b>						
$C_{ies}$	Input Capacitance	$V_{CE} = 30V, V_{GE} = 0V,$ $f = 1MHz$	--	1277	--	pF
$C_{oes}$	Output Capacitance		--	98	--	pF
$C_{res}$	Reverse Transfer Capacitance		--	21	--	pF
<b>Switching Characteristics</b>						
$t_{d(on)}$	Turn-On Delay Time	$V_{CC} = 300V, I_C = 20A,$ $R_G = 10\Omega, V_{GE} = 15V,$ Inductive Load, $T_C = 25^\circ\text{C}$	--	65	130	ns
$t_r$	Rise Time		--	100	200	ns
$t_{d(off)}$	Turn-Off Delay Time		--	80	160	ns
$t_f$	Fall Time		--	100	200	ns
$E_{on}$	Turn-On Switching Loss		--	0.45	--	mJ
$E_{off}$	Turn-Off Switching Loss		--	0.42	--	mJ
$t_{d(on)}$	Turn-On Delay Time	$V_{CC} = 300V, I_C = 20A,$ $R_G = 10\Omega, V_{GE} = 15V,$ Inductive Load, $T_C = 125^\circ\text{C}$	--	70	140	ns
$t_r$	Rise Time		--	100	200	ns
$t_{d(off)}$	Turn-Off Delay Time		--	110	220	ns
$t_f$	Fall Time		--	210	350	ns
$E_{on}$	Turn-On Switching Loss		--	0.5	--	mJ
$E_{off}$	Turn-Off Switching Loss		--	0.72	--	mJ
$T_{sc}$	Short Circuit Withstand Time	$V_{CC} = 300V, V_{GE} = 15V$ @ $T_C = 100^\circ\text{C}$	10	--	--	$\mu s$
$Q_g$	Total Gate Charge	$V_{CE} = 300V, I_C = 20A,$ $V_{GE} = 15V$	--	55	65	nC
$Q_{ge}$	Gate-Emitter Charge		--	10	15	nC
$Q_{gc}$	Gate-Collector Charge		--	20	30	nC

**Electrical Characteristics of DIODE @ Inverter**  $T_C = 25^\circ\text{C}$  unless otherwise noted

Symbol	Parameter	Test Conditions	Min.	Typ.	Max.	Units	
$V_{FM}$	Diode Forward Voltage	$I_F = 20\text{A}$	$T_C = 25^\circ\text{C}$	--	1.9	2.8	V
			$T_C = 100^\circ\text{C}$	--	2.0	--	
$t_{rr}$	Diode Reverse Recovery Time	$I_F = 20\text{A}$ $di/dt = 40\text{ A}/\mu\text{s}$	$T_C = 25^\circ\text{C}$	--	75	150	ns
			$T_C = 100^\circ\text{C}$	--	110	--	
$I_{rr}$	Diode Peak Reverse Recovery Current		$T_C = 25^\circ\text{C}$	--	1.3	2.6	A
			$T_C = 100^\circ\text{C}$	--	1.8	--	
$Q_{rr}$	Diode Reverse Recovery Charge		$T_C = 25^\circ\text{C}$	--	50	195	nC
			$T_C = 100^\circ\text{C}$	--	100	--	

**Electrical Characteristics of DIODE @ Converter**  $T_C = 25^\circ\text{C}$  unless otherwise noted

Symbol	Parameter	Test Conditions	Min.	Typ.	Max.	Units	
$V_{FM}$	Diode Forward Voltage	$I_F = 20\text{A}$	$T_C = 25^\circ\text{C}$	--	1.1	1.5	V
			$T_C = 100^\circ\text{C}$	--	1.0	--	
$I_{RRM}$	Repetitive Reverse Current	$V_R = V_{RRM}$	$T_C = 25^\circ\text{C}$	--	--	8	mA
			$T_C = 100^\circ\text{C}$	--	5	--	

**Thermal Characteristics**

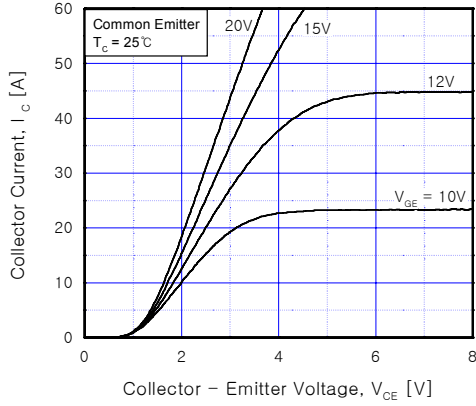
	Symbol	Parameter	Typ.	Max.	Units
Inverter	$R_{\theta JC}$	Junction-to-Case (IGBT Part, per 1/6 Module)	--	1.4	$^\circ\text{C}/\text{W}$
	$R_{\theta JC}$	Junction-to-Case (DIODE Part, per 1/6 Module)	--	2.3	$^\circ\text{C}/\text{W}$
Brake	$R_{\theta JC}$	Junction-to-Case (IGBT Part)	--	1.4	$^\circ\text{C}/\text{W}$
	$R_{\theta JC}$	Junction-to-Case (DIODE Part)	--	2.3	$^\circ\text{C}/\text{W}$
Converter	$R_{\theta JC}$	Junction-to-Case (DIODE Part, per 1/6 Module)	--	1.5	$^\circ\text{C}/\text{W}$
Weight		Weight of Module	60	--	g

**NTC Thermistor Characteristics**

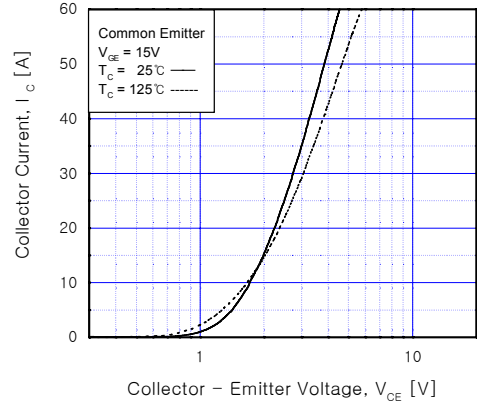
	Symbol	Parameter	Tol.	Typ.	Units
Thermistor	R25	Rated Resistance @ $T_c = 25^\circ\text{C}$	+/- 5 %	4.7	$\text{K}\Omega$
	B(25/100)	B - Value	+/- 3 %	3530	

## Typical Performance Characteristics

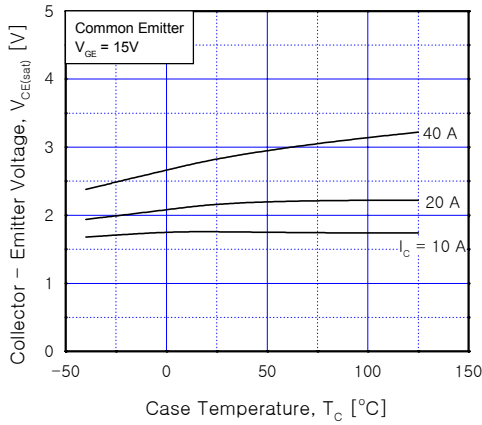
**Figure 1. Typical Output Characteristics**



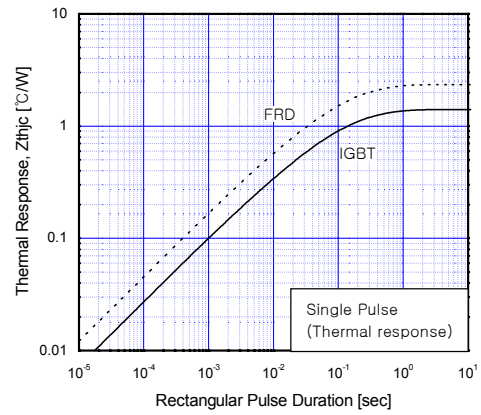
**Figure 2. Typical Saturation Voltage Characteristics**



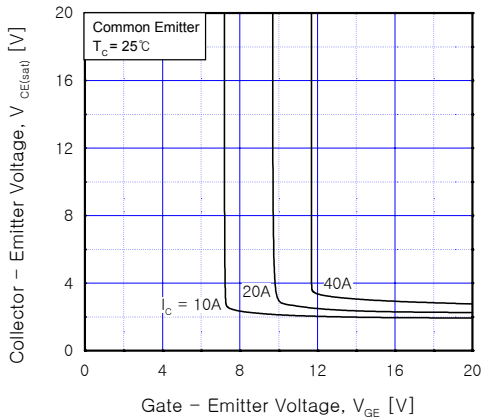
**Figure 3. Saturation Voltage vs. Case Temperature at Variant Current Level**



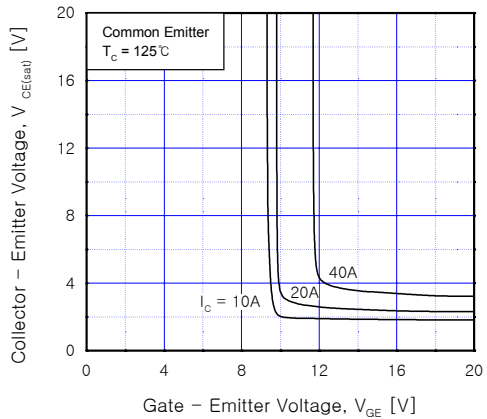
**Figure 4. Transient Thermal Impedance**



**Figure 5. Saturation Voltage vs. V\_GE**

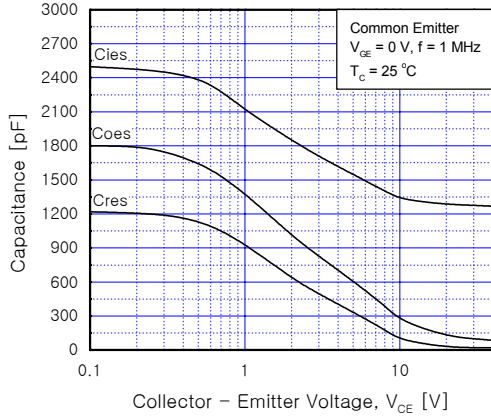


**Figure 6. Saturation Voltage vs. V\_GE**

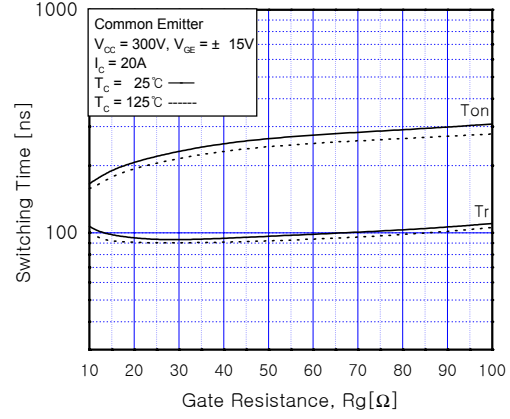


**Typical Performance Characteristics** (Continued)

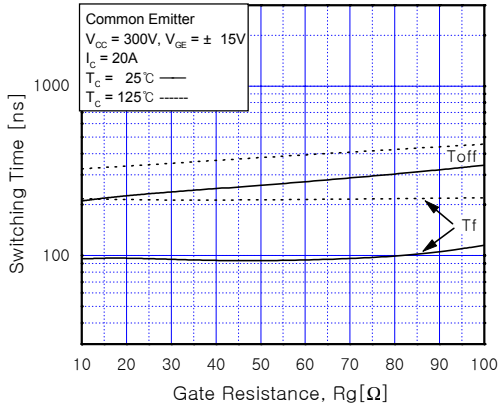
**Figure 7. Capacitance Characteristics**



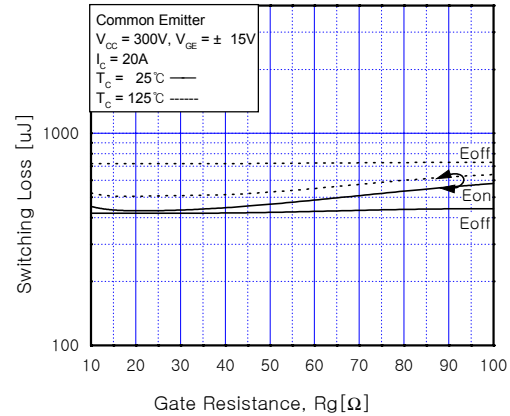
**Figure 8. Turn-On Characteristics vs. Gate Resistance**



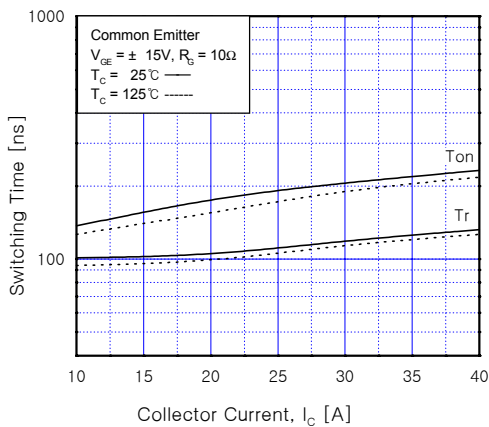
**Figure 9. Turn-Off Characteristics vs. Gate Resistance**



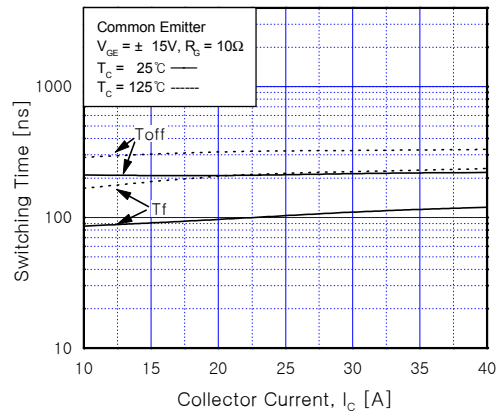
**Figure 10. Switching Loss vs. Gate Resistance**



**Figure 11. Turn-On Characteristics vs. Collector Current**

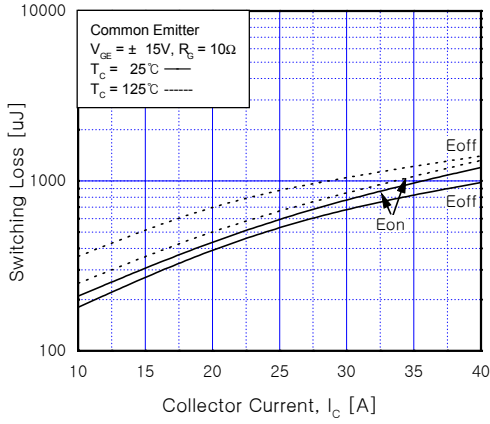


**Figure 12. Turn-Off Characteristics vs. Collector Current**

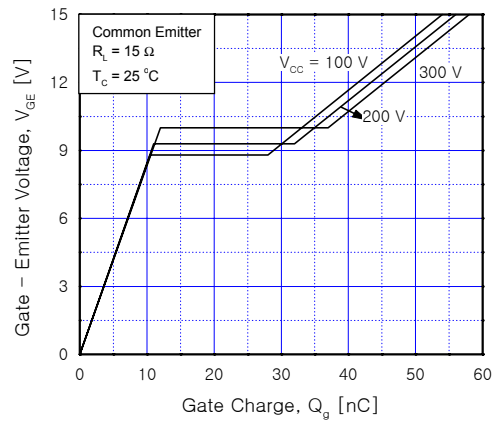


**Typical Performance Characteristics** (Continued)

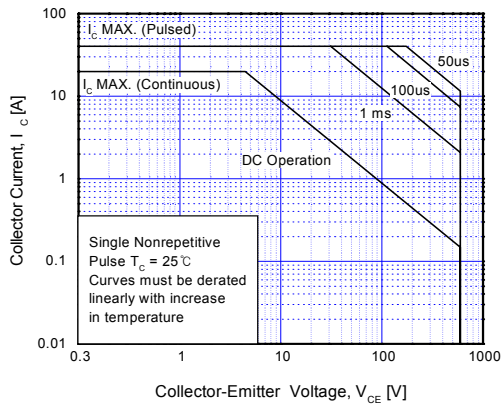
**Figure 13. Switching Loss vs. Collector Current**



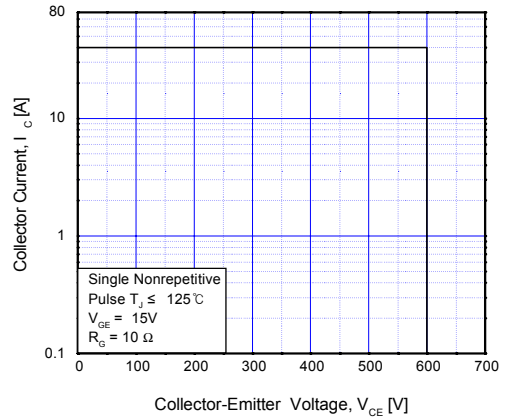
**Figure 14. Gate Charge Characteristics**



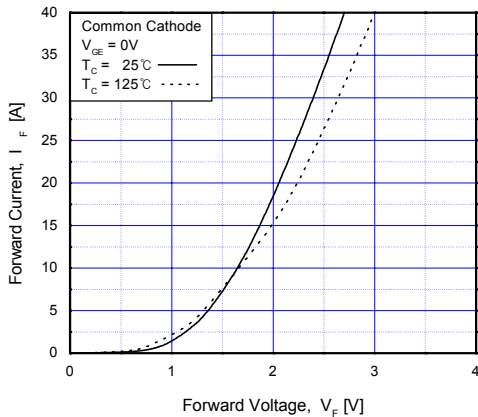
**Figure 15. SOA Characteristics**



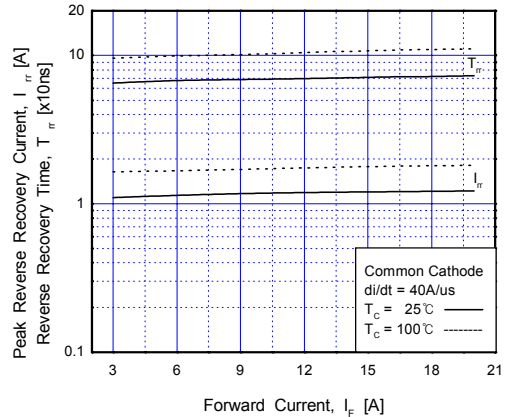
**Figure 16. RBSOA Characteristics**



**Figure 17. Forward Characteristics**

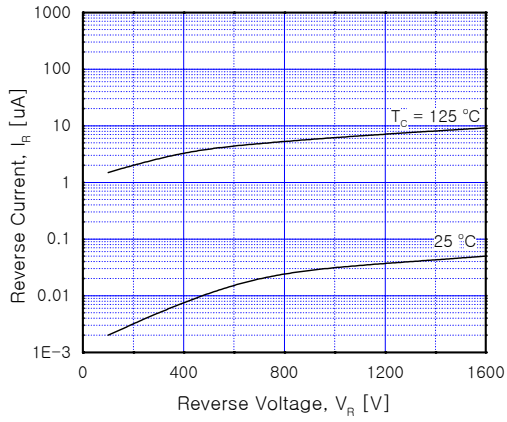


**Figure 18. Reverse Recovery Characteristics**

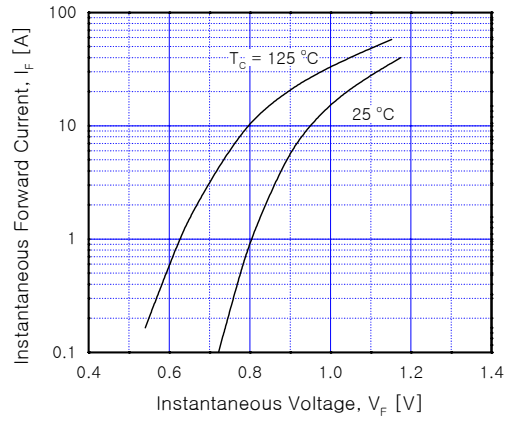


**Typical Performance Characteristics** (Continued)

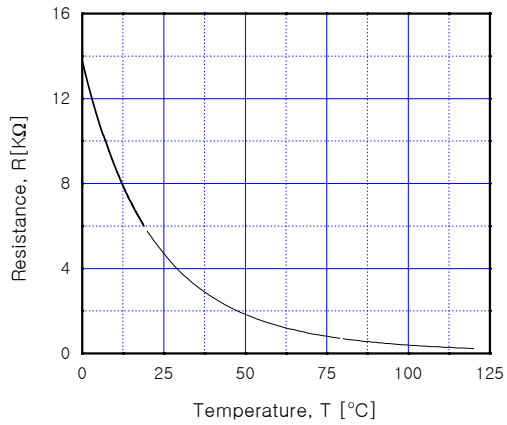
**Figure 19. Rectifier (Converter) Characteristics**



**Figure 20. Rectifier (Converter) Characteristics**



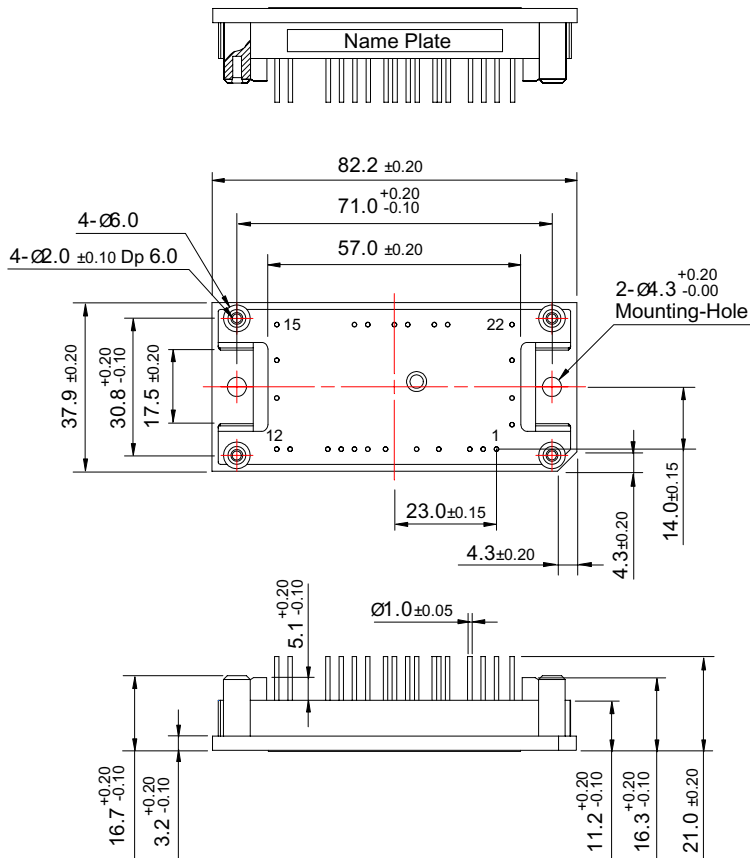
**Figure 21. NTC Characteristics**





# Mechanical Dimensions

## 25PM-AA



- Pin Coordinate

Pin #No	Coordinate	
	x	y
1	0.0	0.0
2	-3.0	0.0
3	-6.0	0.0
4	-13.0	0.0
5	-18.0	0.0
6	-25.0	0.0
7	-29.0	0.0
8	-32.0	0.0
9	-35.0	0.0
10	-38.0	0.0
11	-46.5	0.0
12	-49.5	0.0
13	-49.5	11.5
14	-49.5	20.0
15	-49.5	28.0
16	-32.0	28.0
17	-29.0	28.0
18	-23.0	28.0
19	-20.0	28.0
20	-14.0	28.0
21	-11.0	28.0
22	3.5	28.0
23	3.5	20.0
24	3.5	11.5
25	3.5	5.5

\* datum pin : #1

\* Pin Tilt : ±0.15

Dimensions in Millimeters

## TRADEMARKS

The following are registered and unregistered trademarks Fairchild Semiconductor owns or is authorized to use and is not intended to be an exhaustive list of all such trademarks.

ACEx™	FAST®	ISOPLANAR™	PowerSaver™	SuperSOT™-8
ActiveArray™	FASTr™	LittleFET™	PowerTrench®	SyncFET™
Bottomless™	FPS™	MICROCOUPLER™	QFET®	TinyLogic®
Build it Now™	FRFET™	MicroFET™	QS™	TINYOPTO™
CoolFET™	GlobalOptoisolator™	MicroPak™	QT Optoelectronics™	TruTranslation™
CROSSVOLT™	GTO™	MICROWIRE™	Quiet Series™	UHC™
DOME™	HiSeC™	MSX™	RapidConfigure™	UltraFET®
EcoSPARK™	I <sup>2</sup> C™	MSXPro™	RapidConnect™	UniFET™
E <sup>2</sup> CMOS™	i-Lo™	OCX™	μSerDes™	VCX™
EnSigna™	ImpliedDisconnect™	OCXPro™	SILENT SWITCHER®	Wire™
FACT™	IntelliMAX™	OPTOLOGIC®	SMART START™	
FACT Quiet Series™		OPTOPLANAR™	SPM™	
Across the board. Around the world.™		PACMAN™	Stealth™	
The Power Franchise®		POP™	SuperFET™	
Programmable Active Droop™		Power247™	SuperSOT™-3	
		PowerEdge™	SuperSOT™-6	

## DISCLAIMER

FAIRCHILD SEMICONDUCTOR RESERVES THE RIGHT TO MAKE CHANGES WITHOUT FURTHER NOTICE TO ANY PRODUCTS HEREIN TO IMPROVE RELIABILITY, FUNCTION OR DESIGN. FAIRCHILD DOES NOT ASSUME ANY LIABILITY ARISING OUT OF THE APPLICATION OR USE OF ANY PRODUCT OR CIRCUIT DESCRIBED HEREIN; NEITHER DOES IT CONVEY ANY LICENSE UNDER ITS PATENT RIGHTS, NOR THE RIGHTS OF OTHERS.

## LIFE SUPPORT POLICY

FAIRCHILD'S PRODUCTS ARE NOT AUTHORIZED FOR USE AS CRITICAL COMPONENTS IN LIFE SUPPORT DEVICES OR SYSTEMS WITHOUT THE EXPRESS WRITTEN APPROVAL OF FAIRCHILD SEMICONDUCTOR CORPORATION.

As used herein:

1. Life support devices or systems are devices or systems which, (a) are intended for surgical implant into the body, or (b) support or sustain life, or (c) whose failure to perform when properly used in accordance with instructions for use provided in the labeling, can be reasonably expected to result in significant injury to the user.
2. A critical component is any component of a life support device or system whose failure to perform can be reasonably expected to cause the failure of the life support device or system, or to affect its safety or effectiveness.

## PRODUCT STATUS DEFINITIONS

### Definition of Terms

Datasheet Identification	Product Status	Definition
Advance Information	Formative or In Design	This datasheet contains the design specifications for product development. Specifications may change in any manner without notice.
Preliminary	First Production	This datasheet contains preliminary data, and supplementary data will be published at a later date. Fairchild Semiconductor reserves the right to make changes at any time without notice in order to improve design.
No Identification Needed	Full Production	This datasheet contains final specifications. Fairchild Semiconductor reserves the right to make changes at any time without notice in order to improve design.
Obsolete	Not In Production	This datasheet contains specifications on a product that has been discontinued by Fairchild semiconductor. The datasheet is printed for reference information only.

Rev. I16