

# FMS6417A

## Selectable RGB (YUV) HD/SD Video Filter Driver with Y, C, Composite, and Modulator Outputs

### Features

- YUV/RGB filters
- 2:1 Mux inputs for multiple RGB/YUV inputs
- Selectable 8MHz or 30MHz 6th order filters for RGB (YUV) applications
- 8MHz 6th order Y, C filters with composite summer
- Modulator output with FCC group delay predistortion
- AC or DC coupled input, AC coupled output
- All outputs can drive AC coupled 75Ω loads and provide 6dB of gain
- Dual multiplexed inputs
- 1% differential gain with 1° differential phase
- 36dB/octave roll-off on all channels
- Pin compatible upgrade to the award winning FMS6417

### Applications

- Cable set top boxes
- Satellite set top boxes
- DVD players
- HDTV
- Personal Video Recorders (PVR)
- Video On Demand (VOD)
- Media Centers

### Description

The FMS6417A offers comprehensive filtering for set top box or DVD applications. This part consists of a triple 6th order filter with selectable 30MHz or 8MHz frequencies and a dual filter for filtering Y,C with a composite summer and a modulator channel with sound-notch and FCC group delay compensation. The modulator provides sound-notching and FCC group delay compensation for NTSC.

2-to-1 multiplexers are provided on the triple filters as well as provisions for auxiliary inputs to the composite channel. The triple filters are intended for either YUV or RGB signals. All channels accept AC or DC coupled ground-referenced 1V signals. The filters output 2V<sub>pp</sub> signals into AC coupled terminated loads. The low-pass filters are powered by 3.3V and the modulator and outputs by 5.0V.

### Functional Block Diagram

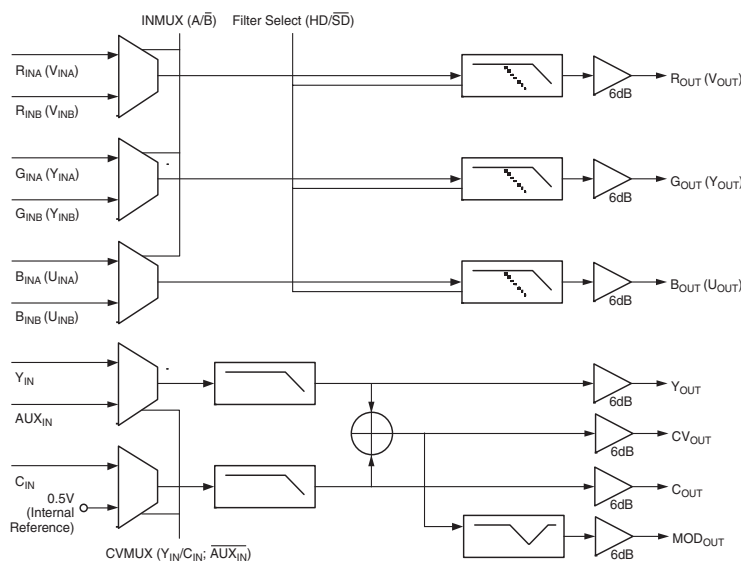

## Pin Configurations

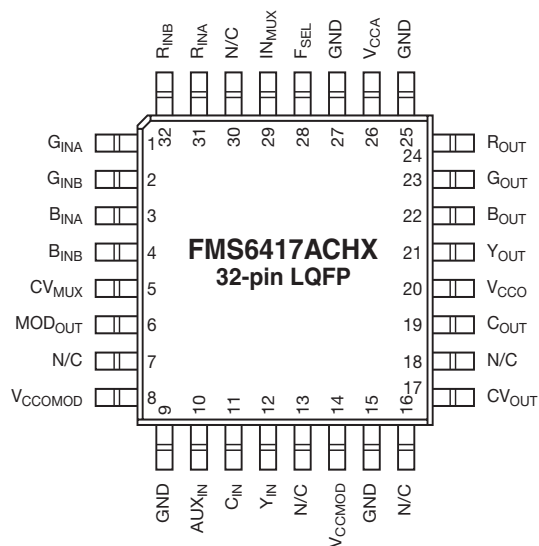

## Pin Assignments

Pin#	Pin	Description
1	G <sub>INA</sub>	Analog GREEN video input for Channel <A>
2	G <sub>INB</sub>	Analog GREEN video input for Channel <B>
3	B <sub>INA</sub>	Analog BLUE video input for Channel <A>
4	B <sub>INB</sub>	Analog BLUE video input for Channel <B>
5	CV <sub>MUX</sub>	Logic input pin selects between the Y <sub>IN</sub> (1) or AUX <sub>IN</sub> (0) inputs as well as enabling or disabling C <sub>IN</sub> . (Do not float)
6	MOD <sub>OUT</sub>	Modulator output
7	N/C	No connect
8	V <sub>CCMOD</sub>	5V V <sub>CC</sub> for modulator output buffers
9	GND	Ground for modulator output buffers
10	AUX <sub>IN</sub>	Filtered analog composite video or luma input
11	C <sub>IN</sub>	Chrominance (Chroma) input
12	Y <sub>IN</sub>	Luminance (Luma) input
13	N/C	No connect
14	V <sub>CCMOD</sub>	5V V <sub>CC</sub> for modulator
15	GND	Ground for modulator
16	N/C	No connect
17	CV <sub>OUT</sub>	Composite video output
18	N/C	No connect
19	C <sub>OUT</sub>	Chrominance (Chroma) output
20	V <sub>CCO</sub>	5V power supply for output buffers of the RGB and CV drivers
21	Y <sub>OUT</sub>	Luminance (Luma) output
22	B <sub>OUT</sub>	Filtered analog BLUE video output from either B <sub>INA</sub> or B <sub>INB</sub>
23	G <sub>OUT</sub>	Filtered analog GREEN video output from either G <sub>INA</sub> or G <sub>INB</sub>
24	R <sub>OUT</sub>	Filtered analog RED video output from either R <sub>INA</sub> or R <sub>INB</sub>
25	GND	Ground for output buffers
26	V <sub>CCA</sub>	V <sub>CC</sub> analog 3.3V supply
27	GND	Analog ground
28	F <sub>SEL</sub>	Select between (0) SD (8.0MHz) and (1) HD (30.0MHz) filters (Do not float)
29	IN <sub>MUX</sub>	Logic input selects between Channel <A> (1) or <B> (0) of the RGB inputs. (Do not float)
30	N/C	No connect
31	R <sub>INA</sub>	Analog RED video input for Channel <A>
32	R <sub>INB</sub>	Analog RED video input for Channel <B>

## Reliability Information

Parameter	Min.	Typ.	Max.	Unit
Junction Temperature			150	°C
Storage Temperature Range	-65		150	°C
Lead Temperature (Soldering, 10s)			300	°C
Thermal Resistance ( $\theta_{JA}$ ), JEDEC Standard Multi-layer Test Boards, Still Air		48		°C/W

## Absolute Maximum Ratings

Parameter	Min.	Max.	Unit
DC Supply Voltage	-0.3	6	V
Analog and Digital I/O	-0.3	$V_{CC} + 0.3$	V
Output Current Any One Channel (Do Not Exceed)		60	mA

### Note:

Functional operation under any of these conditions is NOT implied. Performance and reliability are guaranteed only if operating conditions are not exceeded.  $V_{CCA}$  can not exceed  $V_{CCO}$

## Recommended Operating Conditions

Parameter	Min.	Typ.	Max.	Unit
Operating Temperature Range	0		70	°C
$V_{CCO}$ Range <sup>2</sup>	4.75	5.0	5.25	V
$V_{CCA}$ Range	3.135	3.3	3.465	V
$V_{CCMOD}$ Range <sup>2</sup>	4.75	5.0	5.25	V
$V_{CCOMOD}$ Range <sup>2</sup>	4.75	5.0	5.25	V

## Electrical Specifications

( $T_C = 25^\circ\text{C}$ ,  $V_i = 1V_{pp}$ ;  $V_{CCA} = 3.3V$ ,  $V_{CCMOD} = V_{CCOMOD} = V_{CCO} = 5.0V$ , all inputs AC coupled with  $0.1\mu\text{F}$ , all outputs AC coupled with  $220\mu\text{F}$  into  $150\Omega$ , referenced to  $400\text{kHz}$ ; unless otherwise noted)

Symbol	Parameter	Conditions	Min	Typ	Max	Units
$I_{CCA}$	Supply Current <sup>1</sup>	$V_{CCA}$ no load	50	80	120	mA
$I_{CCO}$	Supply Current <sup>1</sup>	$V_{CCO}$ no load	10	55	70	mA
$I_{CCMOD}$	Modulator Supply Current <sup>1</sup>	$V_{CCMOD}$ no load	10	26	40	mA
$I_{CCOMOD}$	Modulator Output Supply Current <sup>1</sup>	$V_{CCOMOD}$ no load	0.5	4	10	mA
$V_i$	Input Voltage Max	Reference to ground		1.3		$V_{pp}$
$V_{il}$	Digital Input Low <sup>1</sup>	$F_{SEL}$ , $IN_{MUX}$ , $CV_{MUX}$	0		0.8	V
$V_{ih}$	Digital Input High <sup>1</sup>	$F_{SEL}$ , $IN_{MUX}$ , $CV_{MUX}$	2.4		$V_{CCO}$	V
$V_{OCV}$	Output Voltage	During sync, CV channel		1		V
$V_{ORGB}$	Output Voltage	During sync, RGB channel		1		V
$V_{OMOD}$	Output Voltage	During sync, MOD channel		1		V
PSSR	PSSR (all channels)	DC		-46		dB

### Notes:

- 100% tested at  $25^\circ\text{C}$ .
- $V_{CCO}$ ,  $V_{CCMOD}$ , and  $V_{CCOMOD}$  all connected to same supply.

### Standard Definition Electrical Specifications

( $T_C = 25^\circ\text{C}$ ,  $V_i = 1V_{pp}$ ;  $V_{CCA} = 3.3V$ ,  $V_{CCMOD} = V_{CCOMOD} = V_{CCO} = 5.0V$ ,  $F_{SEL} = 0$ , all inputs AC coupled with  $0.1\mu\text{F}$ , all outputs AC coupled with  $220\mu\text{F}$  into  $150\Omega$ , referenced to  $400\text{kHz}$ ; unless otherwise noted)

Symbol	Parameter	Conditions	Min	Typ	Max	Units
$AV_{SD}$	SD Gain <sup>1</sup>	R,G,B channels SD Mode	5.3	6.0	6.6	dB
$f_{1dBSD}$	-1dB Bandwidth for SD <sup>1</sup>	R,G,B,Y,C,CV channels	4	5		MHz
$f_{CSD}$	-3dB Bandwidth for SD	R,G,B,Y,C,CV channels		8		MHz
$f_{SBSD}$	Attenuation: SD (stopband reject) <sup>1</sup>	R,G,B,Y,C channels at $f = 27\text{MHz}$	37	40		dB
$f_{SBCV}$	Attenuation: SD (stopband reject) <sup>1</sup>	CV channel at $f = 27\text{MHz}$	37	40		dB
$f_{NA}$	Notch Attenuation	at $4.425\text{MHz}$	14	20		dB
MCF	Modulator Channel Flatness	at $3.75\text{MHz}$	-0.75	0	+0.75	dB
dG	Differential Gain	R,G,B,Y,C,CV channels		1.0		%
$d\phi$	Differential Phase	R,G,B,Y,C,CV channels		1.0		°
$d\phi_{MOD}$	Modulator Differential Phase	MOD channel		1.5		°
THD	Output Distortion (all channels)	$V_{OUT} = 1.8V_{pp}$ at $3.58\text{MHz}$		0.4		%
$X_{TALKYC}$	Crosstalk	channel-to-channel YC at $1\text{MHz}$		-58		dB
$X_{TALKRGB}$	Crosstalk	channel-to-channel RGB at $1\text{MHz}$		-65		dB
$IN_{MUXISO}$	$IN_{MUX}$ Isolation	at $1\text{MHz}$		-75		dB
SNR	Signal-to-Noise Ratio	R,G,B,Y,C,CV channels, NTC-7 weighting, $100\text{kHz}$ highpass enabled		72		dB
$t_{pdSD}$	Prop Delay for SD	Delay from input to output at $4.5\text{MHz}$ (RGB, YC, CV outputs)		85		ns
$\Delta t_{pdMOD}$	Modulator Group Delay	MODE = 0, from $400\text{kHz}$ to $3.58\text{MHz}$	-230	-170	-130	ns
$t_{CLDCV}$	Chroma-Luma Delay $CV_{OUT}$	$f = 3.58\text{MHz}$ (referenced to $400\text{kHz}$ )		6	50	ns
$t_{CLGCV}$	Chroma-Luma Gain $CV_{OUT}$	$f = 3.58\text{MHz}$ (referenced to $400\text{kHz}$ )	92	100	104	%

### High Definition Electrical Characteristics

( $T_C = 25^\circ\text{C}$ ,  $V_i = 1V_{pp}$ ;  $V_{CCA} = 3.3V$ ,  $V_{CCMOD} = V_{CCOMOD} = V_{CCO} = 5.0V$ ,  $F_{SEL} = 1$ , all inputs AC coupled with  $0.1\mu\text{F}$ , all outputs AC coupled with  $220\mu\text{F}$  into  $150\Omega$ , referenced to  $400\text{kHz}$ ; unless otherwise noted)

Symbol	Parameter	Conditions	Min.	Typ.	Max	Units
$AV_{RGBHD}$	RGB HD Gain <sup>1</sup>	R,G,B channels HD Mode	5.3	6.0	6.6	dB
$f_{1dBHD}$	-1dB Bandwidth for HD <sup>1</sup>	R,G,B channels	16	20		MHz
$f_{CHD}$	-3dB Bandwidth for HD	R,G,B channels		32		MHz
$f_{SBHD}$	Attenuation: HD (stopband reject) <sup>1</sup>	R,G,B channels at $f = 74.25\text{MHz}$	25	30		dB
HD2	2nd Harmonic Distortion	$20\text{MHz}$ fundamental		-48		dBc
HD3	3rd Harmonic Distortion	$20\text{MHz}$ fundamental		-48		dBc
$X_{TALKRGB}$	RGB Crosstalk	(channel-to-channel) at $1\text{MHz}$		-68		dB
$IN_{MUXISO}$	$IN_{MUX}$ Isolation	at $1\text{MHz}$		-75		dB
SNR	Signal-to-Noise Ratio	R,G,B channels		72		dB
$t_{pdHD}$	Prop Delay for HD	Delay from input to output at $16\text{MHz}$		26		ns
$GD_{HD}$	Group Delay	from $400\text{kHz}$ to $30\text{MHz}$		5		ns

#### Notes:

- 100% tested at  $25^\circ\text{C}$ .
- $V_{CCO}$ ,  $V_{CCMOD}$ , and  $V_{CCOMOD}$  all connected to same supply.

### Standard Definition Typical Performance Characteristics

( $T_C = 25^\circ\text{C}$ ,  $V_i = 1V_{pp}$ ;  $V_{CCA} = 3.3V$ ,  $V_{CCMOD} = V_{CCOMOD} = V_{CCO} = 5.0V$ ,  $F_{SEL} = 0$ , all inputs AC coupled with  $0.1\mu\text{F}$ , all outputs AC coupled with  $220\mu\text{F}$  into  $150\Omega$ , referenced to  $400\text{kHz}$ ; unless otherwise noted)

**Figure 1. Freq. Response RGB Channels**

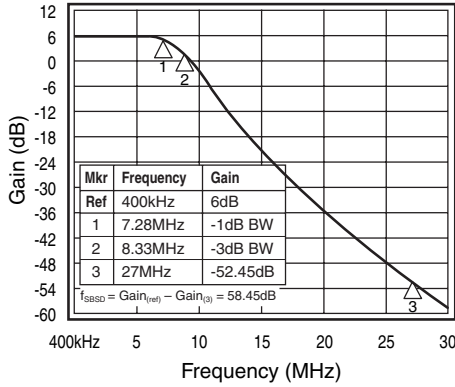

**Figure 2. Freq. Response YCCV Channels**

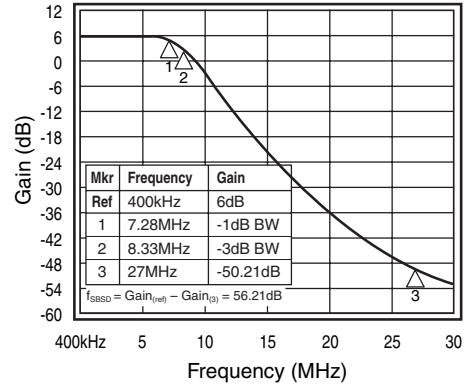

**Figure 3. Group Delay vs. Freq. RGB Channels**

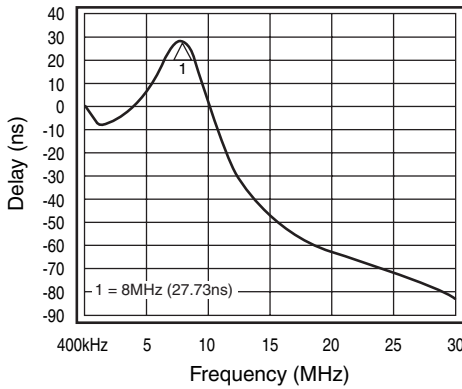

**Figure 4. Group Delay vs. Freq. YCCV Channels**

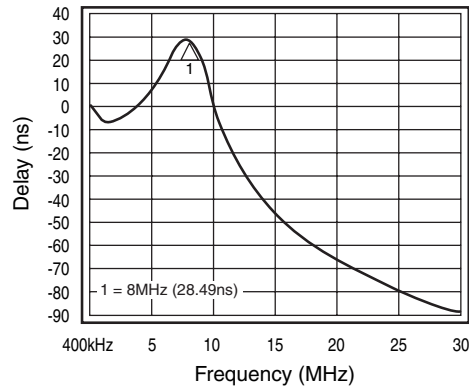

**Figure 5. Modulator Output vs. Frequency**

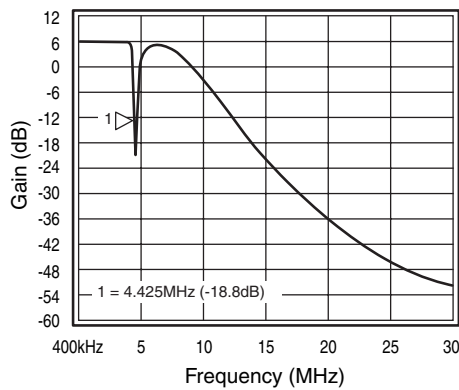

**Figure 6. Noise vs. Frequency RGB Channels**

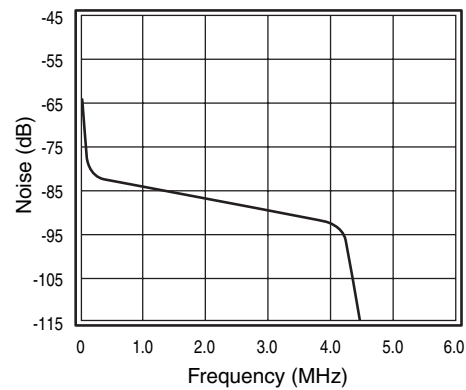

### Standard Definition Typical Performance Characteristics

( $T_C = 25^\circ\text{C}$ ,  $V_i = 1V_{pp}$ ;  $V_{CCA} = 3.3V$ ,  $V_{CCMOD} = V_{CCOMOD} = V_{CCO} = 5.0V$ ,  $F_{SEL} = 0$ , all inputs AC coupled with  $0.1\mu\text{F}$ , all outputs AC coupled with  $220\mu\text{F}$  into  $150\Omega$ , referenced to  $400\text{kHz}$ ; unless otherwise noted)

**Figure 7. Noise vs. Freq. YCCV Channels**

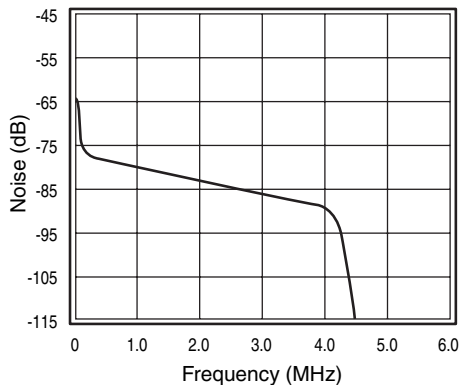

**Figure 8. Noise vs. Freq. Modulator Channels**

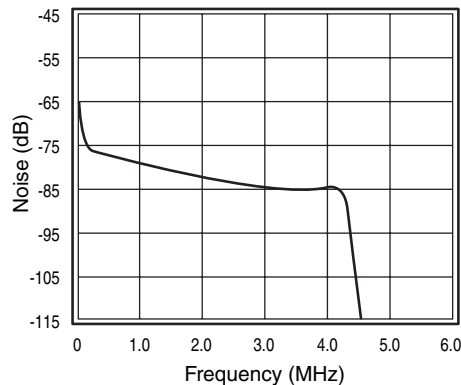

**Figure 9. Differential Gain RGB Channels**

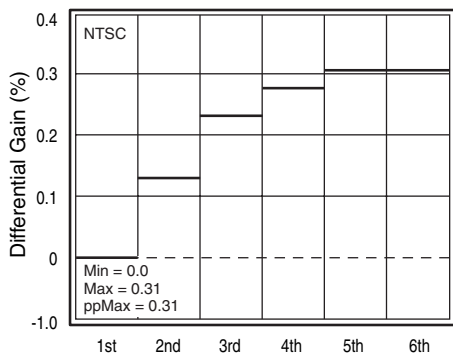

**Figure 10. Differential Phase RGB Channels**

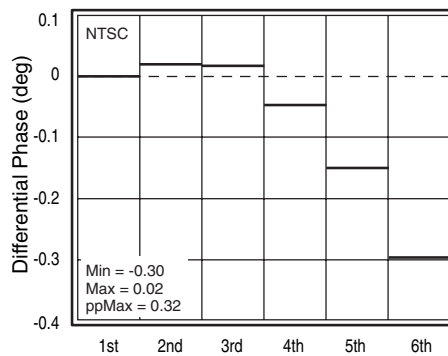

**Figure 11. Differential Gain YCCV Channels**

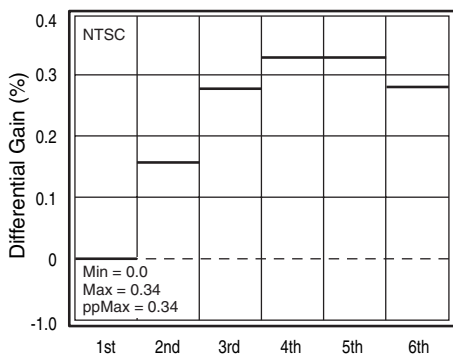

**Figure 12. Differential Phase YCCV Channels**

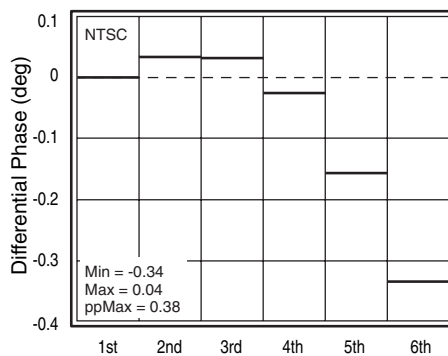

### Standard Definition Typical Performance Characteristics

( $T_C = 25^\circ\text{C}$ ,  $V_i = 1V_{pp}$ ;  $V_{CCA} = 3.3V$ ,  $V_{CCMOD} = V_{CCOMOD} = V_{CCO} = 5.0V$ ,  $F_{SEL} = 0$ , all inputs AC coupled with  $0.1\mu\text{F}$ , all outputs AC coupled with  $220\mu\text{F}$  into  $150\Omega$ , referenced to  $400\text{kHz}$ ; unless otherwise noted)

**Figure 13. Chroma Gain vs. Chroma Delay**

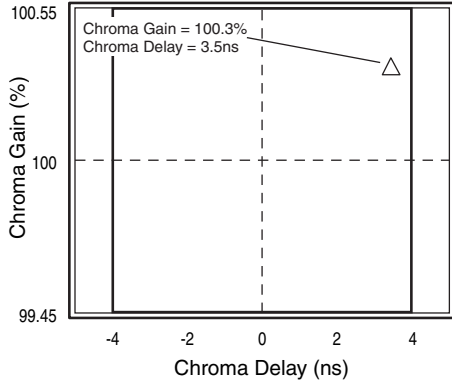

**Figure 14. Modulator Group Delay vs. Freq.**

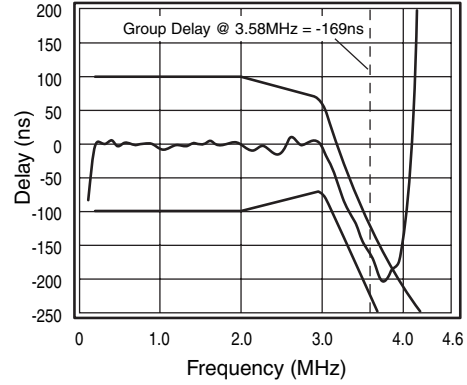

### High Definition Typical Performance Characteristics

( $T_C = 25^\circ\text{C}$ ,  $V_i = 1V_{pp}$ ;  $V_{CCA} = 3.3V$ ,  $V_{CCMOD} = V_{CCMOD} = V_{CCO} = 5.0V$ ,  $F_{SEL} = 1$ , all inputs AC coupled with  $0.1\mu\text{F}$ , all outputs AC coupled with  $220\mu\text{F}$  into  $150\Omega$ , referenced to  $400\text{kHz}$ ; unless otherwise noted)

**Figure 15. HD Freq. Response RGB Channels**

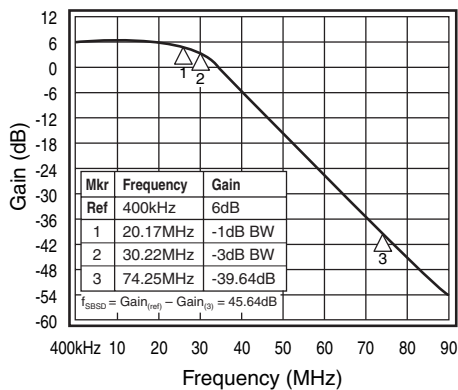

**Figure 16. HD Group Delay RGB Channels**

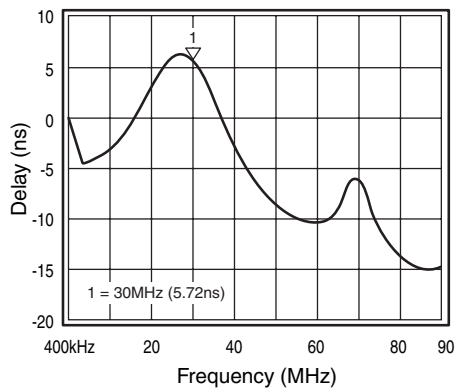

**Figure 17. Noise vs. Freq. RGB Channels**

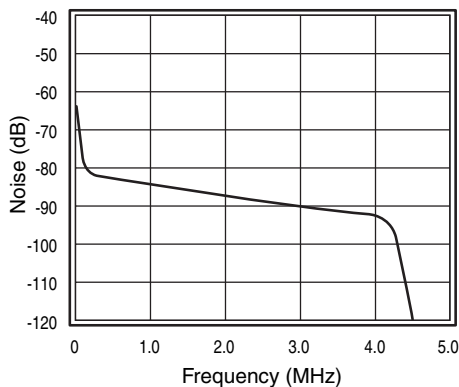



## General Description

The FMS6417A offers comprehensive filtering for set top box or DVD applications. This part consists of a triple 6th order filter with selectable 30MHz or 8MHz frequencies and a dual filter for filtering Y,C with a composite summer and a modulator channel with sound-notch and FCC group delay compensation. The modulator provides sound-notching and FCC group delay compensation for NTSC. 2-to-1 multiplexers are provided on the triple filters as well as provisions for auxiliary inputs to the composite channel. The triple filters are intended for either YUV or RGB signals. All channels accept DC coupled ground-referenced 1V signals. The filters output  $2V_{pp}$  signals into AC coupled terminated loads. The low-pass filters are powered by 3.3V and the modulator and outputs by 5.0V.

The FMS6417A is a next generation filter solution from Fairchild Semiconductor, addressing the expanding filtering needs for set top boxes, and DVD players. The product provides selectable filtering from 30MHz or 8MHz on the RGB channels. Thus, the FMS6417A addresses the requirement for a single set top box to be compatible with a variety of resolution standards. Additionally, the product provides additional filters for Y, C, CV, and modulator outputs. Multiplexers on the RGB and CV channel provide further flexibility.

For DVD applications, the product provides filtering and output drive amplification for 7 channels of outputs. These include R, G, B, Y, C, CV, and modulator outputs.

For set top boxes, this product provides for 2 channels of video to be filtered, as well as the flexibility of selectable high order filtering for multiple resolution standards. Additional flexibility is provided by the additional Y,C filters with composite summers.

All channels provide 6dB gain, accept 1V ground referenced inputs, and drive AC coupled loads. The filters for the R, G, B, Y, C, and CV channels are powered from a 3.3V supply and the modulator channel and outputs from 5V.

The modulator channel has sound-notch and FCC group delay compensation set for NTSC specifications.

## Applications

### Typical Application Diagrams

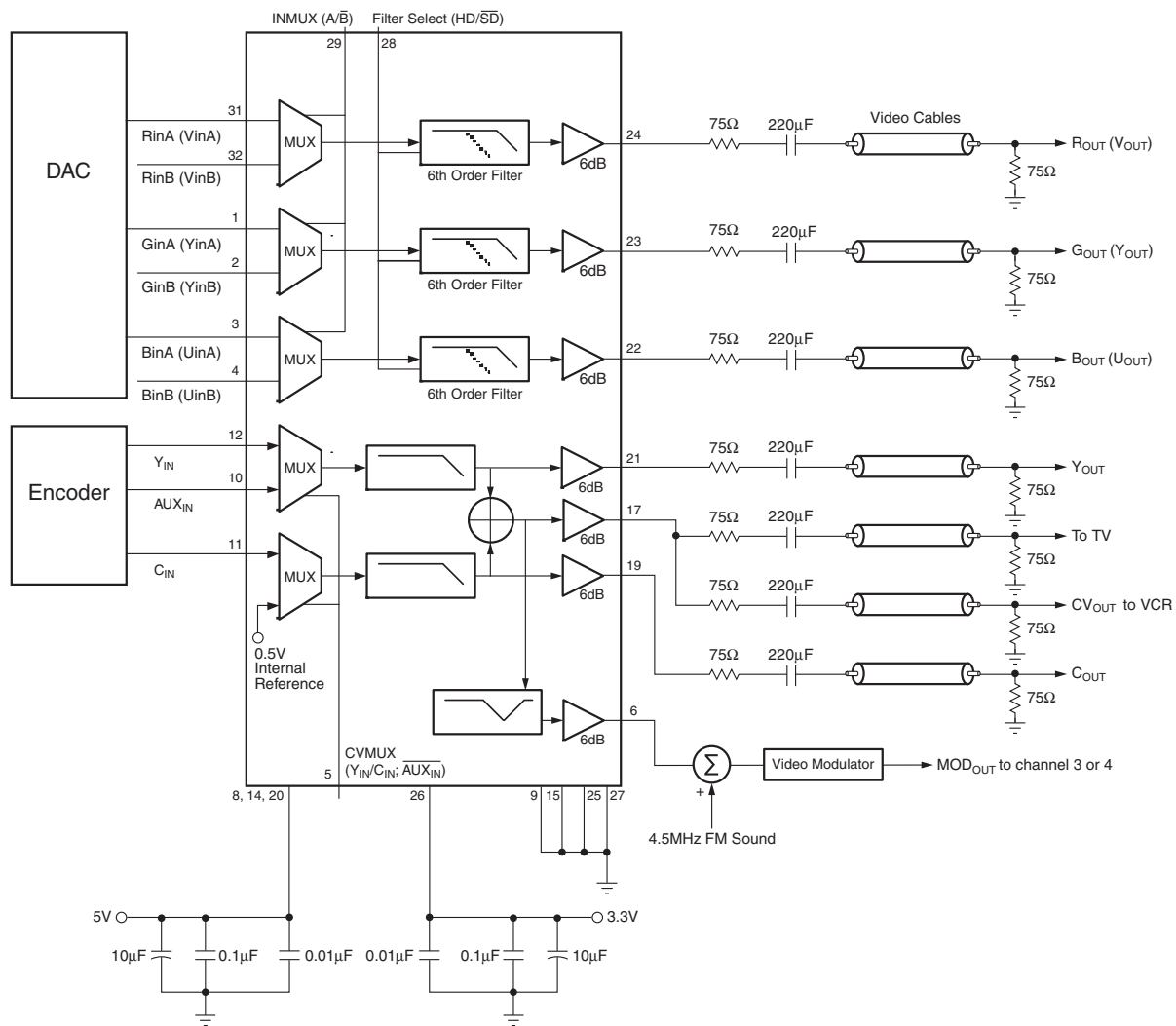
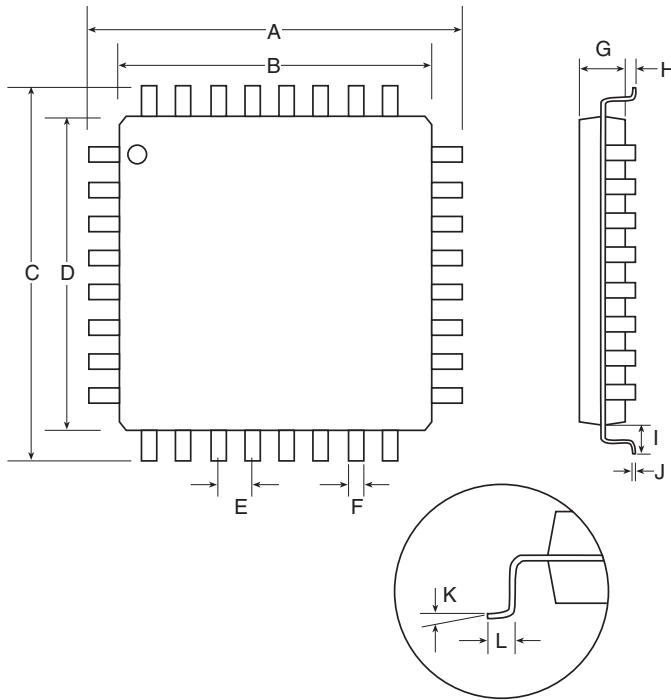

Figure 18. Typical application diagram (DC-coupled input)



### Mechanical Dimensions

LQFP-32



Symbol	MILLIMETERS	
	Min	Max
A	8.80	9.20
B	6.90	7.10
C	8.80	9.20
D	6.90	7.10
E	0.80 BSC	
F	0.30	0.47
G	1.35	1.45
H	0.05	0.15
I	0.95	1.05
J	0.09	0.2
K	0°	7°
L	0.45	0.75

### Ordering Information

Model	Part Number	Lead Free	Package	Container	Pack Qty.
FMS6417A	FMS6417ACH_NL	Yes	32-pin LQFP	Tray	250
FMS6417A	FMS6417ACHX_NL	Yes	32-pin LQFP	Tape and Reel	1,000

Temperature Range: 0°C to +70°C

**TRADEMARKS**

The following are registered and unregistered trademarks Fairchild Semiconductor owns or is authorized to use and is not intended to be an exhaustive list of all such trademarks.

ACEx™	FAST®	IntelliMAX™	POP™	SPM™
ActiveArray™	FASTr™	ISOPLANAR™	Power247™	Stealth™
Bottomless™	FPS™	LittleFET™	PowerEdge™	SuperFET™
CoolFET™	FRFET™	MICROCOUPLER™	PowerSaver™	SuperSOT™-3
CROSSVOLT™	GlobalOptoisolator™	MicroFET™	PowerTrench®	SuperSOT™-6
DOME™	GTO™	MicroPak™	QFET®	SuperSOT™-8
EcoSPARK™	HiSeC™	MICROWIRE™	QS™	SyncFET™
E <sup>2</sup> CMOS™	I <sup>2</sup> C™	MSX™	QT Optoelectronics™	TinyLogic®
EnSigna™	i-Lo™	MSXPro™	Quiet Series™	TINYOPTO™
FACT™	ImpliedDisconnect™	OCX™	RapidConfigure™	TruTranslation™
FACT Quiet Series™		OCXPro™	RapidConnect™	UHC™
Across the board. Around the world.™		OPTOLOGIC®	µSerDes™	UltraFET®
The Power Franchise®		OPTOPLANAR™	SILENT SWITCHER®	UniFET™
Programmable Active Droop™		PACMAN™	SMART START™	VCX™

**DISCLAIMER**

FAIRCHILD SEMICONDUCTOR RESERVES THE RIGHT TO MAKE CHANGES WITHOUT FURTHER NOTICE TO ANY PRODUCTS HEREIN TO IMPROVE RELIABILITY, FUNCTION OR DESIGN. FAIRCHILD DOES NOT ASSUME ANY LIABILITY ARISING OUT OF THE APPLICATION OR USE OF ANY PRODUCT OR CIRCUIT DESCRIBED HEREIN; NEITHER DOES IT CONVEY ANY LICENSE UNDER ITS PATENT RIGHTS, NOR THE RIGHTS OF OTHERS.

**LIFE SUPPORT POLICY**

FAIRCHILD'S PRODUCTS ARE NOT AUTHORIZED FOR USE AS CRITICAL COMPONENTS IN LIFE SUPPORT DEVICES OR SYSTEMS WITHOUT THE EXPRESS WRITTEN APPROVAL OF FAIRCHILD SEMICONDUCTOR CORPORATION. As used herein:

- |   |   |
|---|---|
| <p>1. Life support devices or systems are devices or systems which, (a) are intended for surgical implant into the body, or (b) support or sustain life, or (c) whose failure to perform when properly used in accordance with instructions for use provided in the labeling, can be reasonably expected to result in significant injury to the user.</p> | <p>2. A critical component is any component of a life support device or system whose failure to perform can be reasonably expected to cause the failure of the life support device or system, or to affect its safety or effectiveness.</p> |
|---|---|

**PRODUCT STATUS DEFINITIONS**

**Definition of Terms**

Datasheet Identification	Product Status	Definition
Advance Information	Formative or In Design	This datasheet contains the design specifications for product development. Specifications may change in any manner without notice.
Preliminary	First Production	This datasheet contains preliminary data, and supplementary data will be published at a later date. Fairchild Semiconductor reserves the right to make changes at any time without notice in order to improve design.
No Identification Needed	Full Production	This datasheet contains final specifications. Fairchild Semiconductor reserves the right to make changes at any time without notice in order to improve design.
Obsolete	Not In Production	This datasheet contains specifications on a product that has been discontinued by Fairchild semiconductor. The datasheet is printed for reference information only.

Rev. 115