

FEB212-004 User Guide
FSFR2100 Evaluation Board Test Report
Application for LCD TV Power Supply

Featured Fairchild Products: FSFR2100

<http://www.fairchildsemi.com/evalboard/>



Table of Contents

1. Featured Fairchild Products	3
1.1. FSFR2100	3
1.2. Power Supply Specification Table	3
1.3. Board Schematic	4
1.4. Bill of Materials	5
1.5. Transformer Specification.....	6
1.6. FSFR2100 (LLC) Printed Circuit Board.....	7
2. Test Results	8
2.1. Primary-Side MOSFET Voltage and Current Waveforms	8
2.2. Secondary-Side Rectifier Diodes Voltage and Current Waveforms	10
2.3. On/Off Waveforms	12
2.4. Output Voltage Ripple	14
2.5. Hold-Up Time Test.....	15
2.6. Protection Operation Waveforms	16
2.7. Efficiency	17

1. Featured Fairchild Products

1.1. FSFR2100

FSFR2100 is an integrated Pulse-Frequency-Modulation (PFM) controller and MOSFETs especially designed for Zero-Voltage-Switching (ZVS) resonant half-bridge converter topologies.

- Variable frequency control with 50% duty cycle for half-bridge resonant converter topology
- High efficiency through zero voltage switching (ZVS)
- Internal SuperFETs with fast recovery type body diode ($t_{rr}=120\text{ns}$)
- Fixed dead time (350ns)
- Up to 300kHz operating frequency
- Pulse skipping for frequency limit (programmable) at light-load condition
- Simple remote ON/OFF control
- Various protection functions: Over-Voltage Protection (OVP), Overload Protection (OLP), Over-Current Protection (OCP), Abnormal Over-Current Protection (AOCP), Internal Thermal Shutdown (TSD)

1.2. Power Supply Specifications

20ms hold-up time for $V_{IN}=390V_{DC}$

Application	FPS Device	Input Voltage Range	Rated Output Power	Output Voltage (Rated Current)
LCD TV	FSFR2100	V_{IN} nominal: $390V_{DC}$ • ($340\sim 400V_{DC}$) V_{CC} supply: $18V_{DC}$	192W	24V-8A

Description	Min.	Typ.	Max.	Units
Input Voltage (V_{IN})	340V	390V	400V	V_{DC}
Output Voltage (V_{OUT})		24V		V_{DC}
Output Current (I_{OUT})	0		8	A_{DC}
Rated Output Power (P_O)			192	W

1.3. Board Schematic

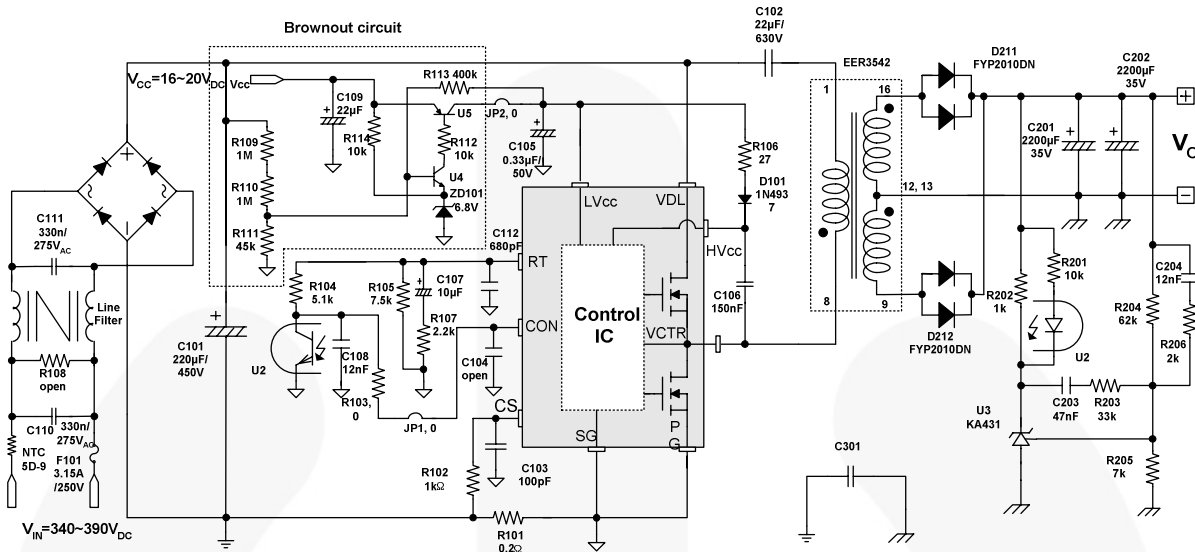

Figure 1. FSFR2100 Evaluation Board (LCC Resonant Converter)

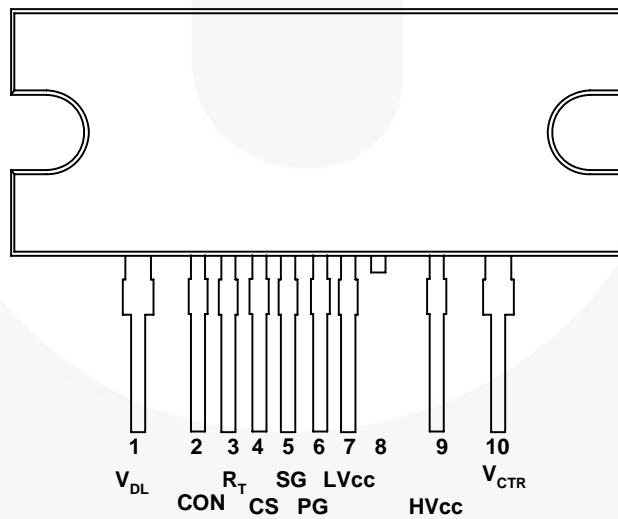

Figure 2. FSFR2100 Package Diagram (9-SIP)

1.4. Bill of Materials

Item Number	Part Reference	Value	Note	Digi-Key	Manufacturer
1	C101	220µF/450V _{DC}	Electrolytic		Samyoung Electronics
2	C102	22nF/630V	Film		Samwha Electronics
3	C103	100pF	Ceramic		Samwha Electronics
4	C104	Open			
5	C105	0.33µF/50V	Electrolytic		Samyoung Electronics
6	C106	150nF	Film		Samwha Electronics
7	C107	10µF/50V	Electrolytic		Samyoung Electronics
8	C108	12nF	Film		Samwha Electronics
9	C109	22µF/50V	Electrolytic		Samyoung Electronics
10	C110, C111	330nF/275V _{AC}	Interference Suppression Film		Pilkor Electronics
11	C112	680pF	Ceramic		Samwha Electronics
12	C201, C202	2200µF/35V	Electrolytic		Samyoung Electronics
13	C203	47nF	Film		Samwha Electronics
14	C204	12nF	Film		Samwha Electronics
15	C301	3.3nF	AC ceramic		Samwha Electronics
16	R101	0.2Ω	1W	RS10.21%R-ND	Stackpole Electronics Inc.
17	R102	1kΩ	1/4W	1.00KXTR-ND	YAGEO
18	R103	Short			
19	R104	5.1kΩ	1/4W	5.11KXTR-ND	YAGEO
20	R105	7.5kΩ	1/4W	7.50KXTR-ND	YAGEO
21	R106	27Ω	1/4W	27.4XTR-ND	YAGEO
22	R107	2.2kΩ	1/4W	2.21KXTR-ND	YAGEO
23	R108	open			
24	R109, R110	1MΩ	1/4W	1.00MXTR-ND	YAGEO
25	R111	45kΩ	1/4W	45.3KXTR-ND	YAGEO
26	R112	10kΩ	1/4W	10.0KXTR-ND	YAGEO
27	R113	400kΩ	1/4W	402KXTR-ND	YAGEO
28	R114, R201	10kΩ	1/4W	10.0KXTR-ND	YAGEO
29	R202	1kΩ	1/4W	1.00KXTR-ND	YAGEO
30	R203	33kΩ	1/4W	33.2KXTR-ND	YAGEO
31	R204	62kΩ	1/4W	61.9KXTR-ND	YAGEO
32	R205	7KΩ	1/4W	6.98KXTR-ND	YAGEO
33	R206	2kΩ	1/4W	2.00KXTR-ND	YAGEO
34	RT101	5D-9			
35	LF101	23mH			
36	D101	1N4937	600V/1A	1N4937-ND	Fairchild Semiconductor
37	D211, D212	FYP2010DN	100V/20A	FYP2010DNTU-ND	Fairchild Semiconductor
38	Z101	1N4736	6.8V	1N4736A-ND	Fairchild Semiconductor
39	BD101	RBV606	Bridge Diode		Fairchild Semiconductor
40	F101	3.15A/250V			
41	U1	FSFR2100	FPS™	FSFR2100-ND	Fairchild Semiconductor
42	U2	H11A817B	Opto-Coupler	H11Ab17B-ND	Fairchild Semiconductor
43	U3	KA431	Voltage Reference	KA431LZTA-ND	Fairchild Semiconductor
44	U4	2N2222	NPN Transistor	PN2222BU-ND	Fairchild Semiconductor
45	U5	2N2907	PNP Transistor	PN2907-ND	Fairchild Semiconductor

1.5. Transformer Specification

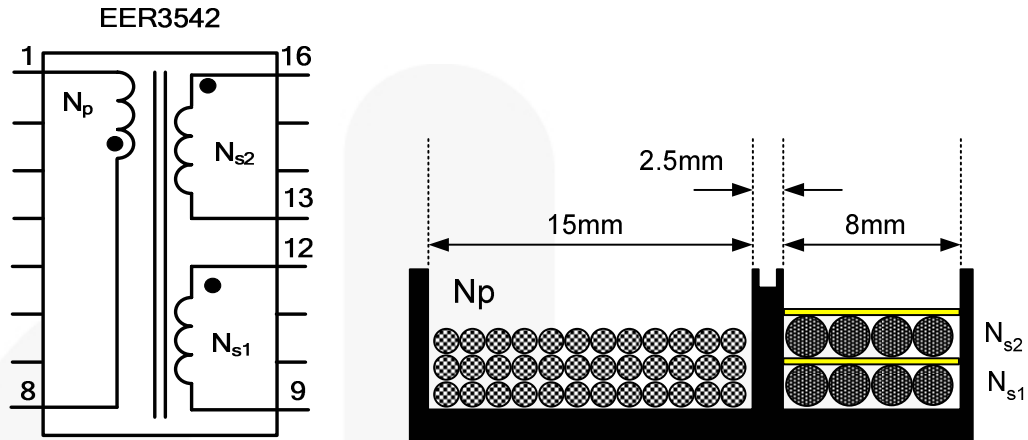

Figure 3. Transformer Specifications

1.5.1 Winding Specification

	Pin (S → F)	Wire	Turns	Winding Method
N_p	8 → 1	0.12φ×30 (Litz wire)	36	Section winding
N_{s1}	12 → 9	0.1φ×100 (Litz wire)	4	Section winding
N_{s2}	16 → 13	0.1φ×100 (Litz wire)	4	Section winding

1.5.2 Core & Bobbin

Core: EER3542 ($A_e=107\text{mm}^2$)
Bobbin: EER3542 (Horizontal)

1.5.3 Electrical Specifications

	Pin	Specification	Remark
Primary-Side Inductance (L_P)	1-8	630μH ± 5%	100kHz, 1V
Primary-Side Effective Leakage (L_R)	1-8	135μH Maximum	Short one of the secondary windings

For more detailed information regarding the transformer, visit <http://www.santronics-usa.com/documents.html> or contact sales@santronics-usa.com or +1-408-734-1878 (Sunnyvale, California USA).

1.6. FSFR2100 (LLC) Printed Circuit Board

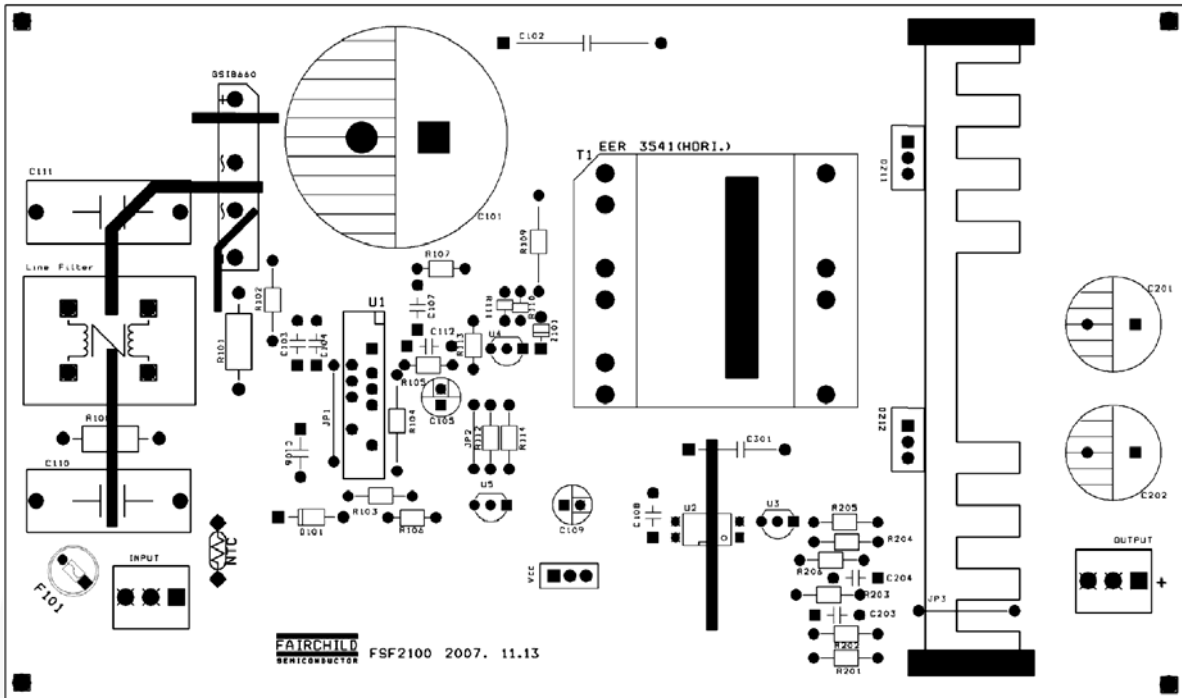

Figure 4. Top PCB Image of the Evaluation Board

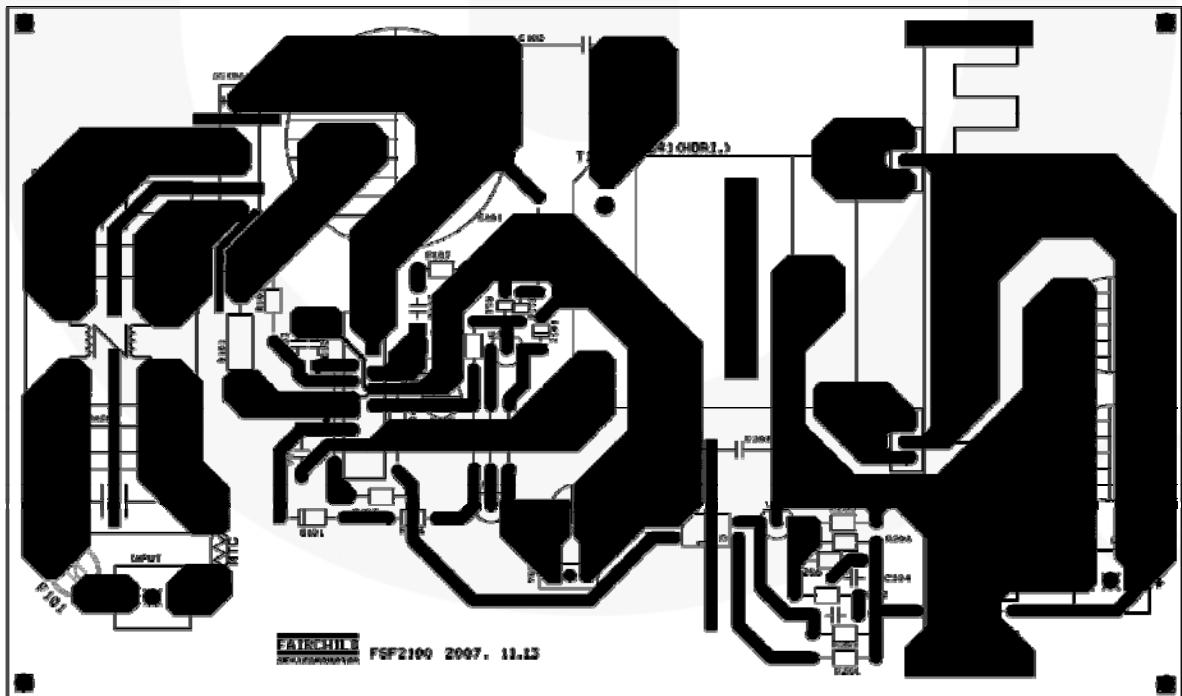

Figure 5. Bottom PCB Image of the Evaluation Board

2. Test Results

2.1. Primary-Side MOSFET Voltage and Current Waveforms

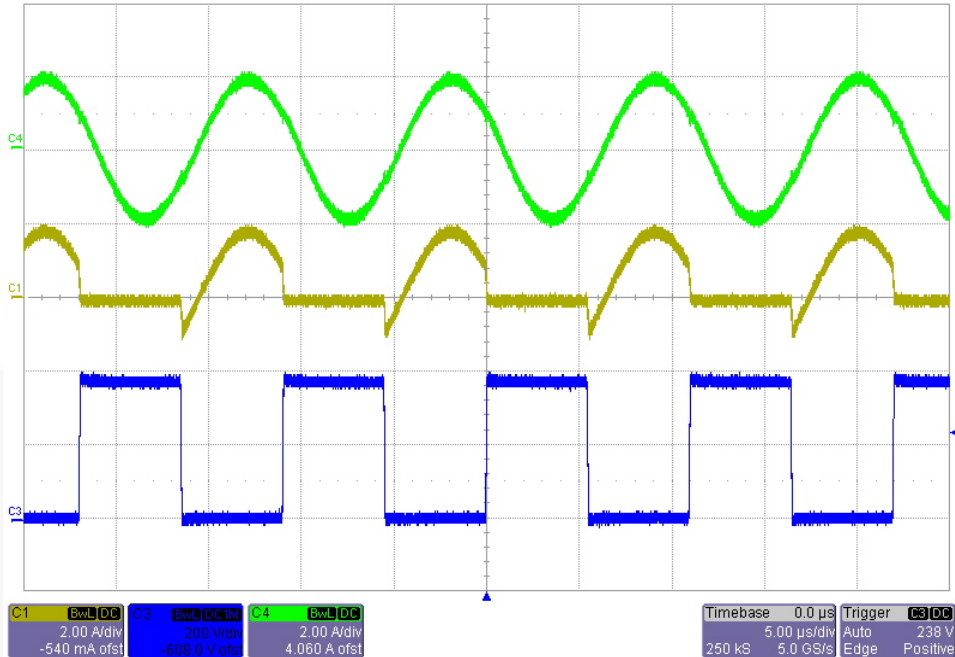

Figure 6. Operation Waveforms at Nominal Input Voltage [$V_{IN}=390V_{DC}$, $P_O=192W$ (24V/8A)]
C4: Transformer Primary-Side Current (2A/div), C1: Low-Side MOSFET Current (2A/div)
C3: Low-Side MOSFET V_{DS} (200V/div), Time: 5 μ s/div

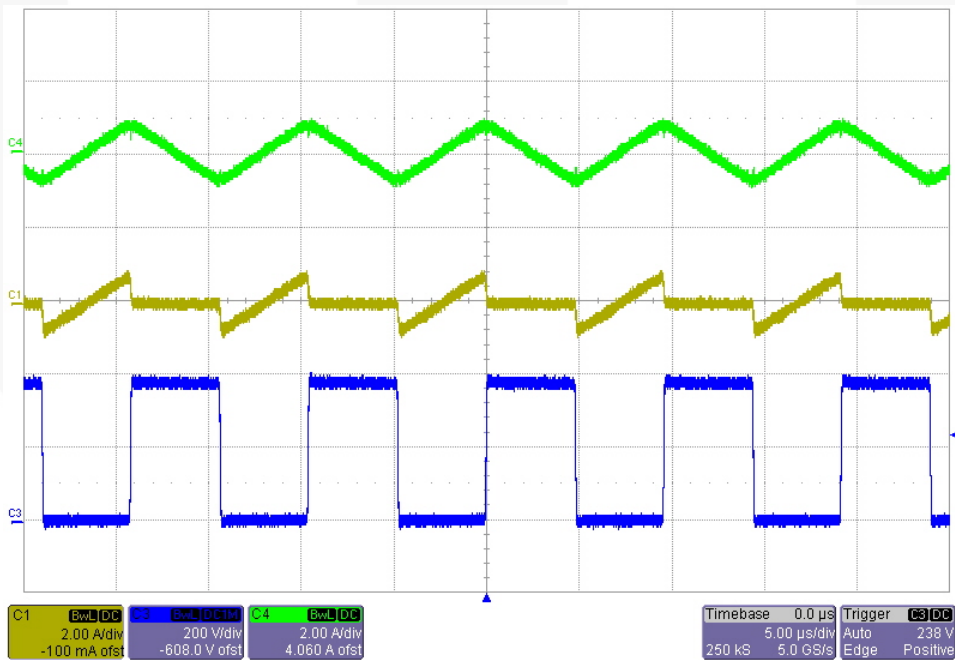

Figure 7. Operation Waveforms at Nominal Input Voltage [$V_{IN}=390V_{DC}$, $P_O=0W$ (24V/0A)]
C4: Transformer Primary-Side Current (2A/div), C1: Low-Side MOSFET Current (2A/div)
C3: Low-Side MOSFET V_{DS} (200V/div), Time: 5 μ s/div

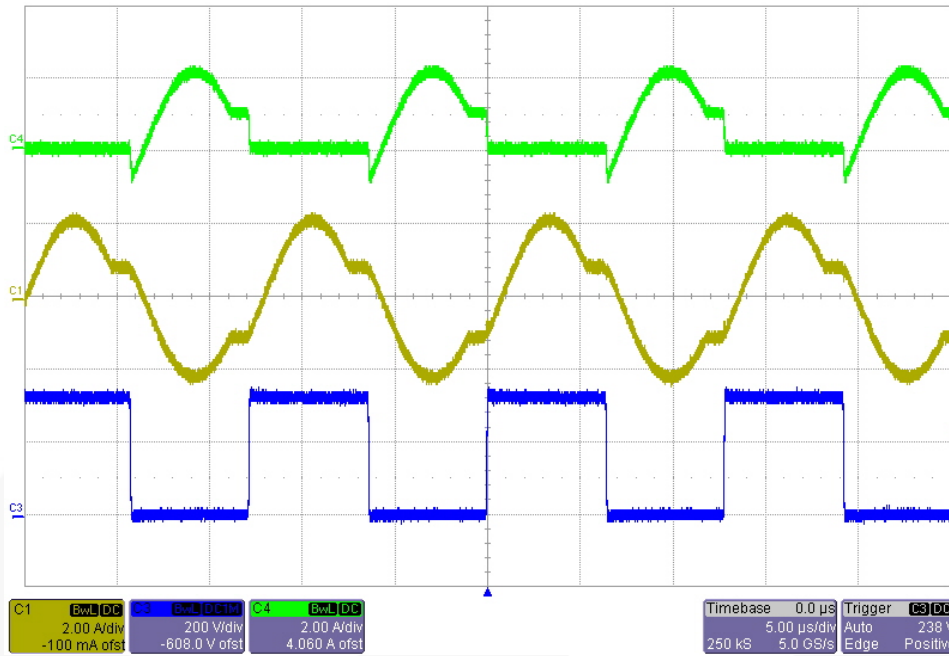

Figure 8. Operation Waveforms at Minimum Input Voltage [$V_{IN}=340V_{DC}$, $P_O=192W$ (24V/8A)]
C4: Transformer Primary-Side Current (2A/div), C1: Low-Side MOSFET Current (2A/div)
C3: Low-Side MOSFET V_{DS} (200V/div), Time: 5 μ s/div

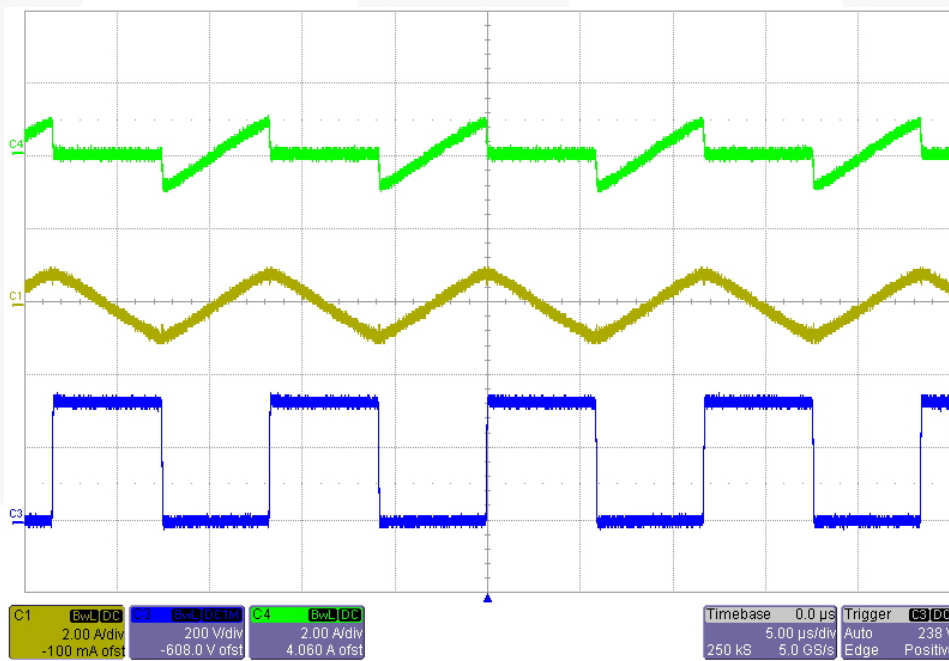

Figure 9. Operation Waveforms at Minimum Input Voltage [$V_{IN}=340V_{DC}$, $P_O=0W$ (24V/0A)]
C4: Transformer Primary-Side Current (2A/div), C1: Low-Side MOSFET Current (2A/div)
C3: Low-Side MOSFET V_{DS} (200V/div), Time: 5 μ s/div

2.2. Secondary-Side Rectifier Diodes Voltage and Current Waveforms

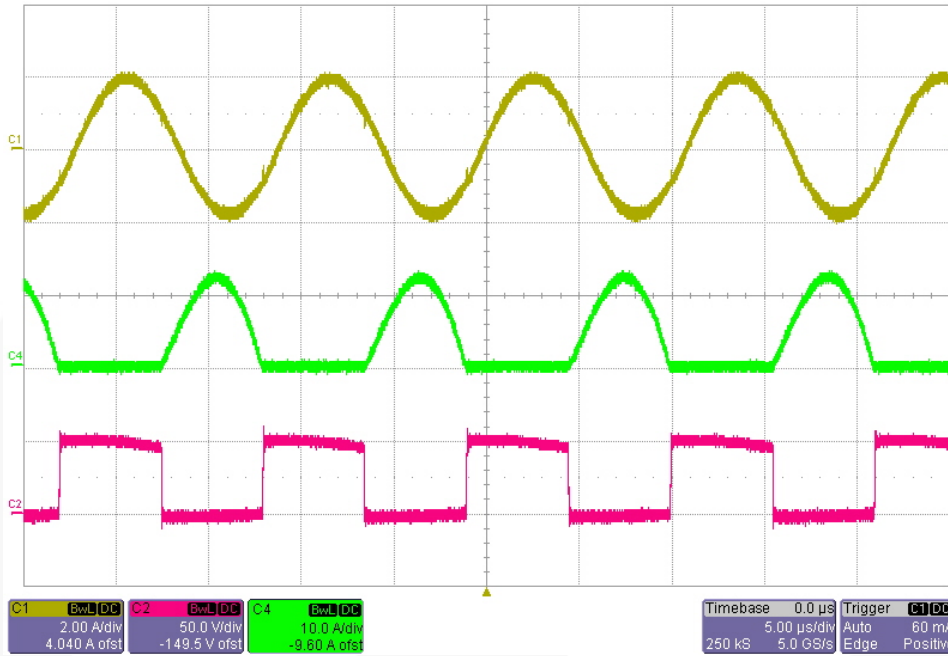

Figure 10. Operation Waveforms at Nominal Input Voltage [$V_{IN}=390V_{DC}$, $P_O=192W$ (24V/8A)]
C1: Transformer Primary-Side Current (2A/div), C4: Rectifier Diode (D211) Current (10A/div)
C2: Rectifier Diode (D211) Voltage (50V/div), Time: 5µs/div

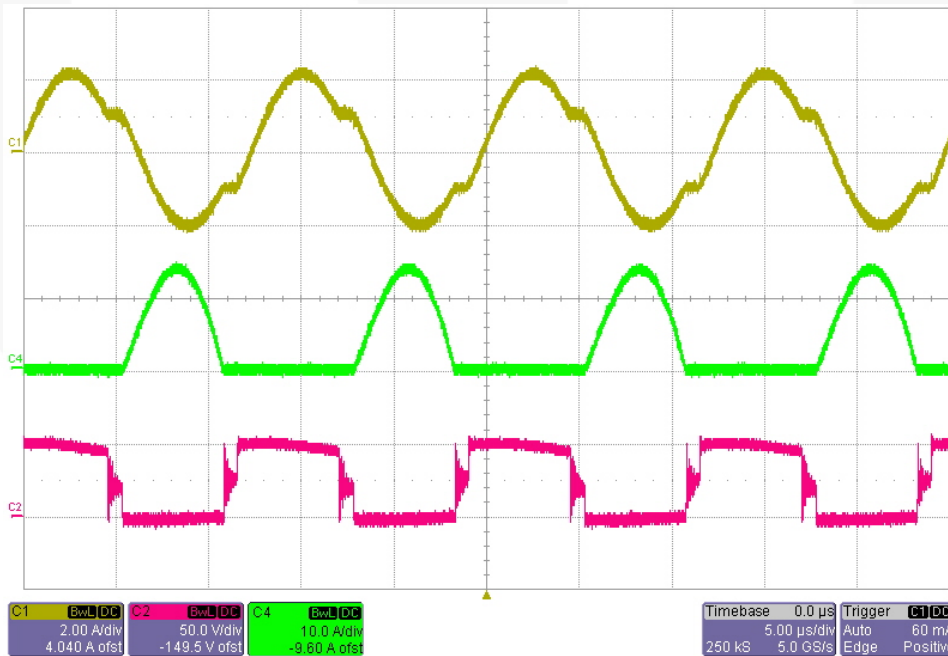

Figure 11. Operation Waveforms at Minimum Input Voltage [$V_{IN}=340V_{DC}$, $P_O=192W$ (24V/8A)]
C1: Transformer Primary-Side Current (2A/div), C4: Rectifier (D211) Diode Current (10A/div)
C2: Rectifier Diode (D211) Voltage (50V/div), Time: 5µs/div

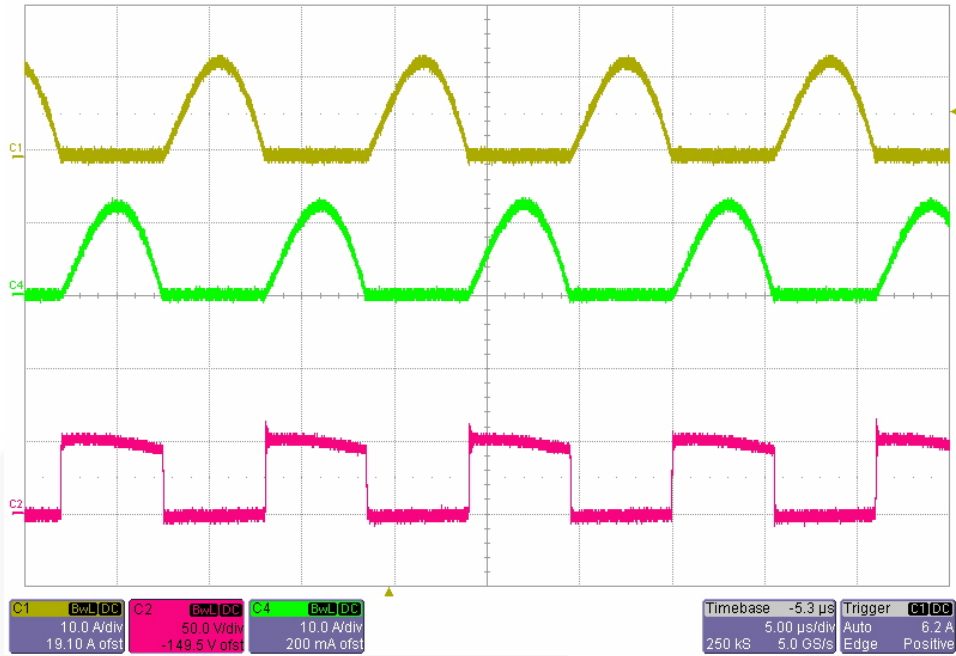

Figure 12. Operation Waveforms at Nominal Input Voltage [$V_{IN}=390V_{DC}$, $P_O=192W$ (24V/8A)]
C1: Rectifier Diode (D211) Current (10A/div), C4: Rectifier Diode (D212) Current (10A/div)
C3: Rectifier Diode Voltage (50V/div), Time: 5μs/div

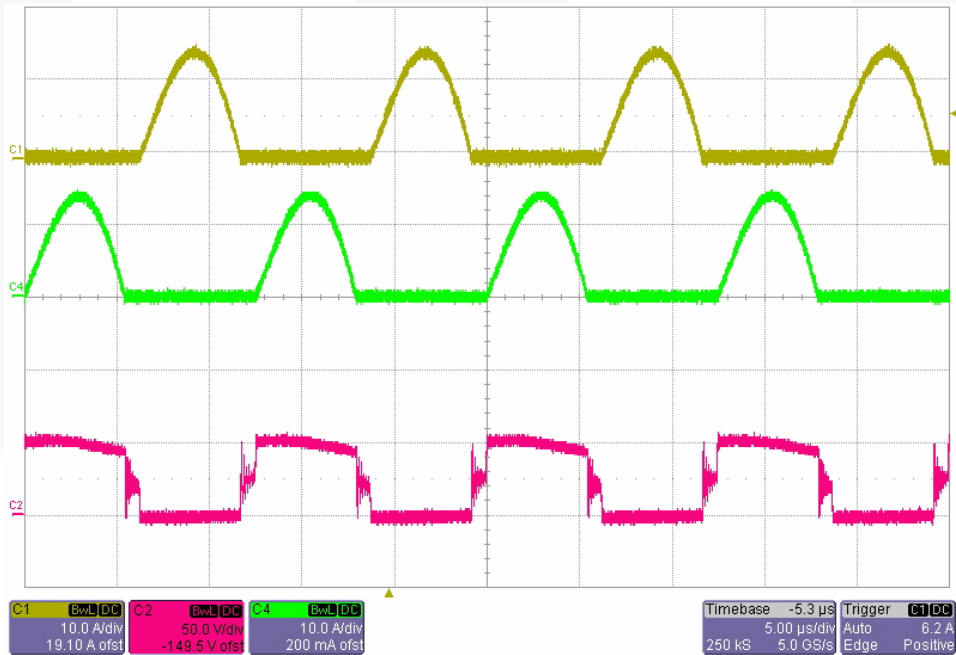

Figure 13. Operation Waveforms at Minimum Input Voltage [$V_{IN}=340V_{DC}$, $P_O=192W$ (24V/8A)]
C1: Rectifier Diode (D211) Current (10A/div), C4: Rectifier Diode (D212) Current (10A/div)
C3: Rectifier Diode Voltage (50V/div), Time: 5μs/div

2.3. On/Off Waveforms

Figures 14 and 15 show the soft-start waveforms at full-load and no-load conditions, respectively, for nominal input voltage condition. For these waveforms, the input DC bus is applied first, then V_{CC} for FSFR2100 is supplied.

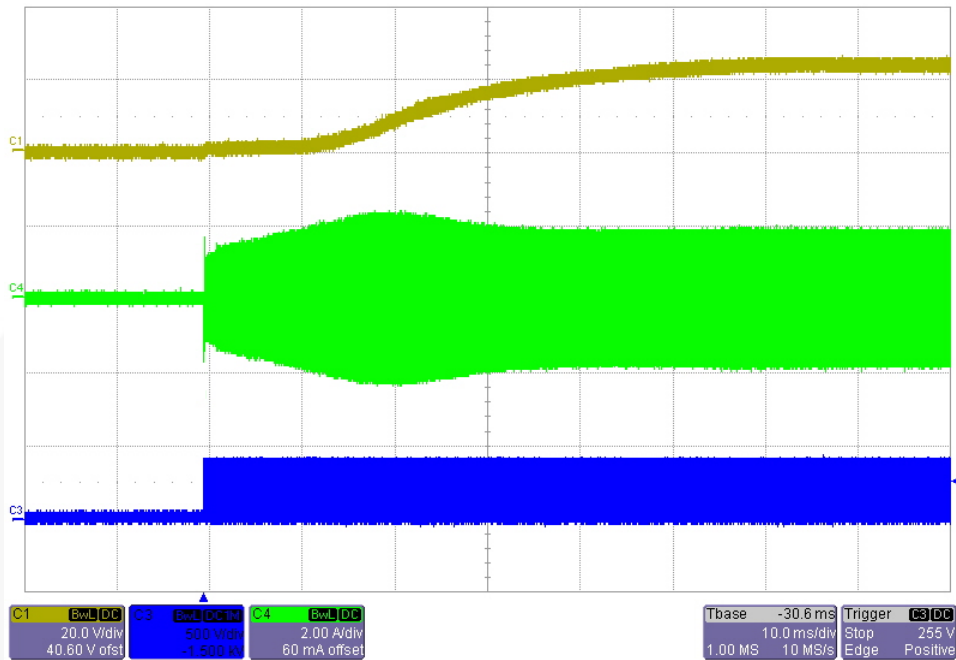

Figure 14. Startup Waveforms at Nominal Input Voltage [$V_{IN}=390V_{DC}$, $P_O=192W$ (24V/8A)]
C1: Output Voltage (20V/div), C4: Transformer Primary-Side Current (2A/div)
C3: Low-Side MOSFET V_{DS} (500V/div), Time: 10ms/div

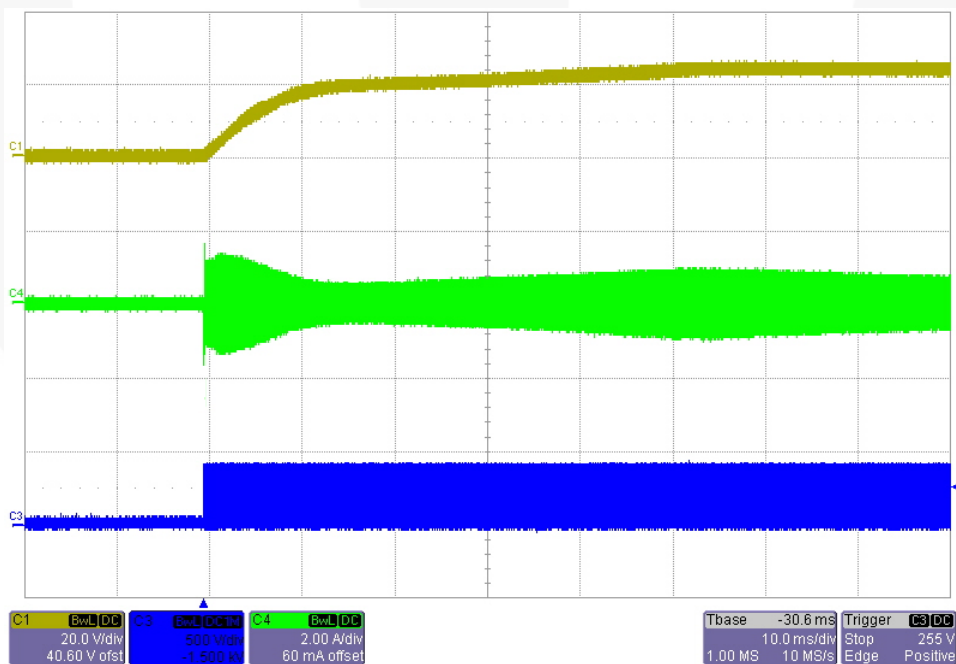

Figure 15. Startup Waveforms at Nominal Input Voltage [$V_{IN}=390V_{DC}$, $P_O=0W$ (24V/0A)]
C1: Output Voltage (20V/div), C4: Transformer Primary-Side Current (2A/div)
C3: Low-Side MOSFET V_{DS} (500V/div), Time: 10ms/div

Figure 16 shows startup waveforms when V_{CC} of 18V is supplied first, then the input voltage source is applied. When the DC bus voltage reaches $\sim 330V$, the external brownout circuit connects V_{CC} supply voltage to FSFR2100 so it starts up. Figure 17 shows shutdown waveforms when the input voltage source is turned off. When the DC bus voltage reaches $\sim 260V$, the external brownout circuit disconnects V_{CC} from FSFR2100 so it stops operation.

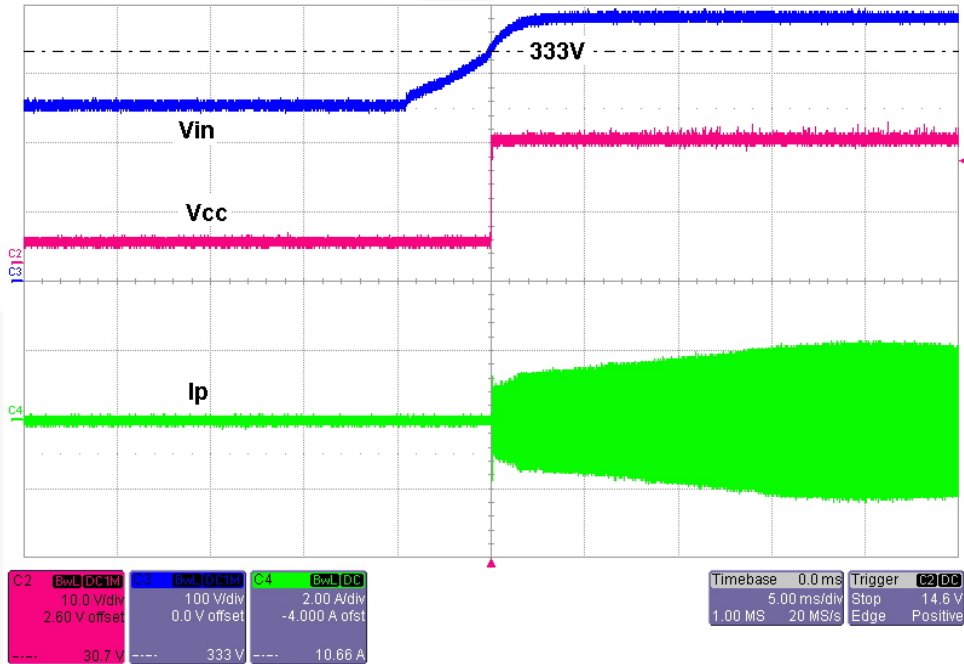

Figure 16. Power-on Waveforms at Nominal Input Voltage [$V_{IN}=390V_{DC}$, $P_O=192W$ (24V/8A)]
C1: Output Voltage (20V/div), C4: Transformer Primary-Side Current (2A/div)
C3: Low-Side MOSFET V_{DS} (500V/div), Time: 5ms/div

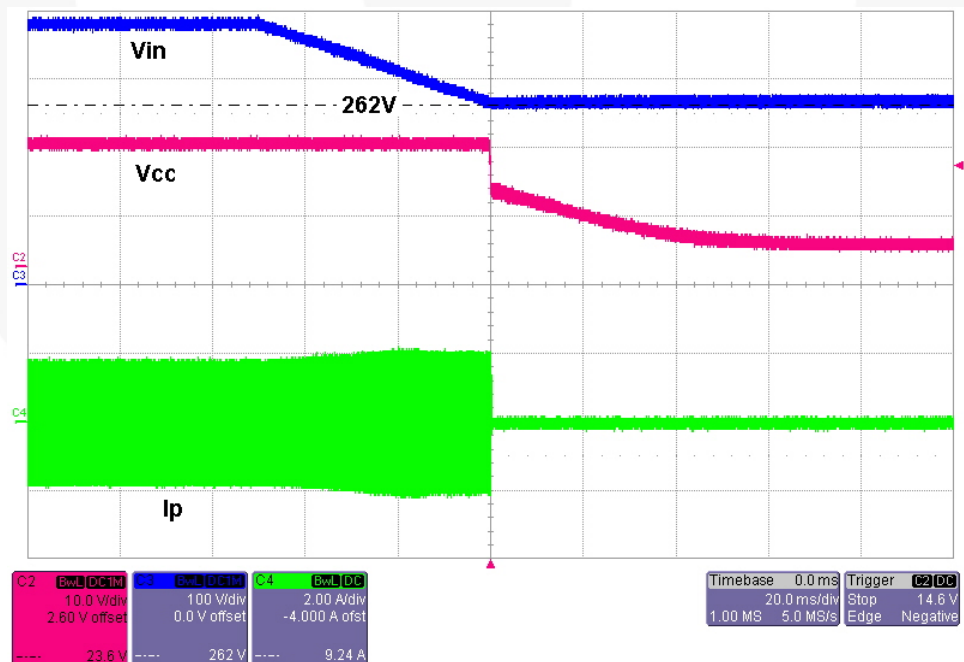

Figure 17. Power-Off Waveforms at Nominal Input Voltage [$V_{IN}=390V_{DC}$, $P_O=192W$ (24V/8A)]
C3: Input Voltage (100V/div), C2: V_{CC} Supply Voltage (10V/div)
C4: Transformer Primary-Side Current (2A/div), Time: 20ms/div

2.4. Output Voltage Ripple

Figure 18 shows the output voltage ripple at nominal input voltage and full-load condition. The peak-to-peak ripple voltage is 0.5V, about 2% of the output voltage. Figure 19 shows the output voltage ripple with pulse load at nominal input voltage. The peak-to-peak ripple voltage is 0.8V, about 3% of the output voltage.

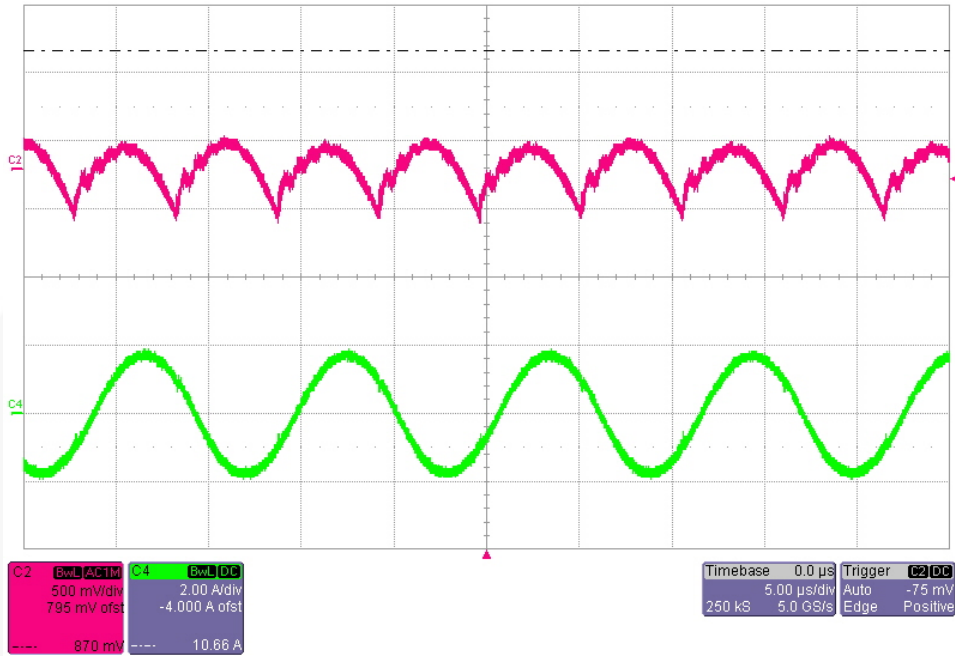

Figure 18. Output Voltage Ripple at Nominal Input Voltage [$V_{IN}=390V_{DC}$, $P_O=192W$ (24V/8A)]
C2: Output Voltage (500mV/div), C4: Transformer Primary-Side Current (2A/div), Time: 20ms/div

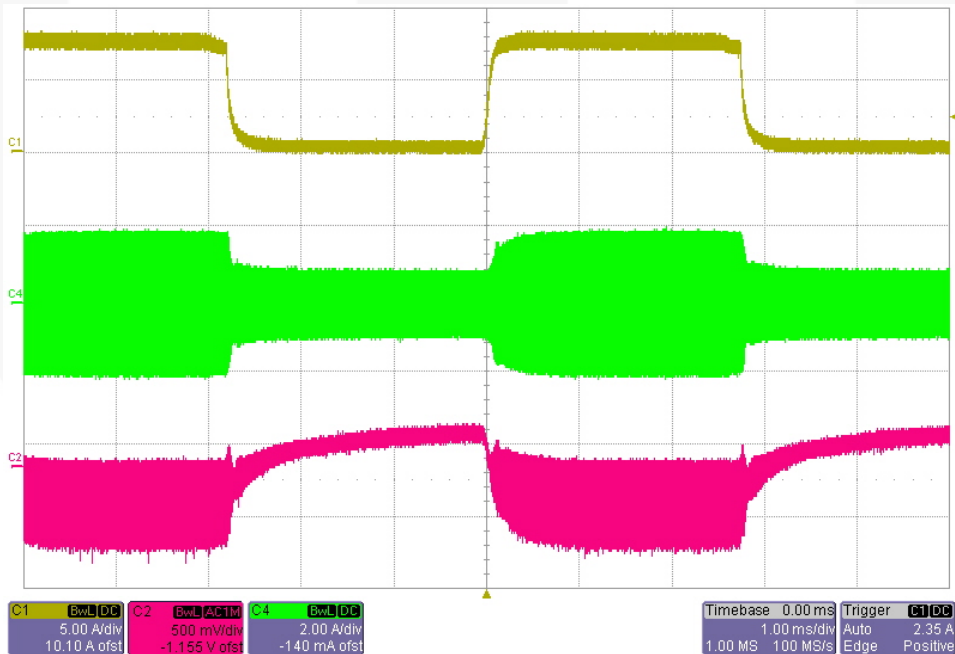

Figure 19. Output Voltage Ripple with Pulse Load Current at Nominal Input Voltage
[$V_{IN}=390V_{DC}$, ($I_o=0A \leftrightarrow 8A$, Slew Rate=50mA/μs, Duty Cycle=50%, Frequency=180Hz)]
C1: Output Current (5A/div), C4: Transformer Primary-Side Current (2A/div)
C2: Output Voltage Ripple, Time: 20ms/div

2.5. Hold-Up Time Test

To see the hold-up time, the input DC bus is disconnected while the converter operates in full-load condition. Observe that the output voltage is maintained for 34ms when the input DC bus is disconnected.

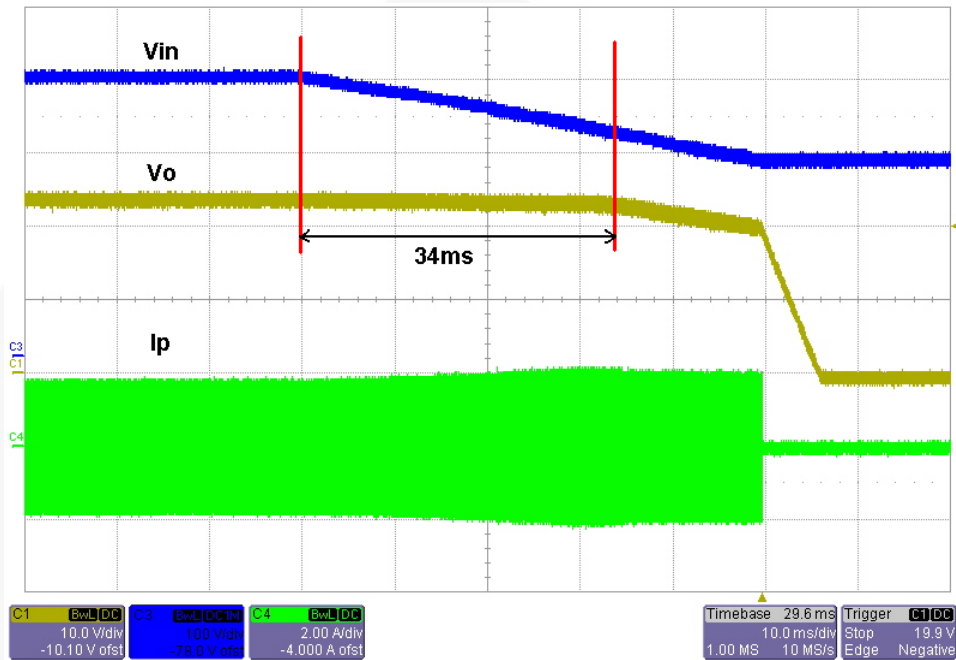

Figure 20. Output Voltage Waveform after Turning Off Input Voltage [$V_{IN}=390V_{DC}$, $P_O=192W$ (24V/8A)]
C3: Input Voltage (100V/div), C1: Output Voltage (10V/div)
C4: Transformer Primary-Side Current (2A/div), Time: 10ms/div

2.6. Protection Operation Waveforms

Figure 21 shows the overload protection (OLP) waveforms. The output current increases from 8A to 16A. When the transformer primary-side current reaches its trip point of 3A, the over-current protection is triggered. Figure 22 shows the output short protection waveforms. When the transformer primary-side current reaches its trip point of 3A, the over-current protection is triggered.

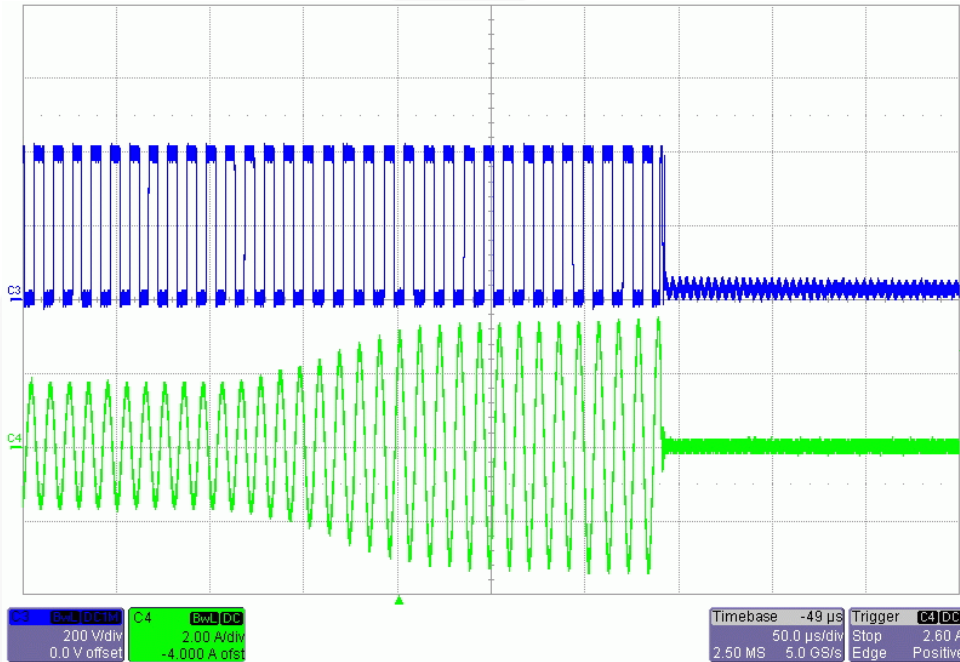

Figure 21. Protection Waveform at Overload Condition [$V_{IN}=390V_{DC}$, ($I_O=8A \rightarrow 16A$)]
C3: Low-Side Drain Voltage (200V/div), C4: Transformer Primary-Side Current (2A/div), Time: 50μs/div

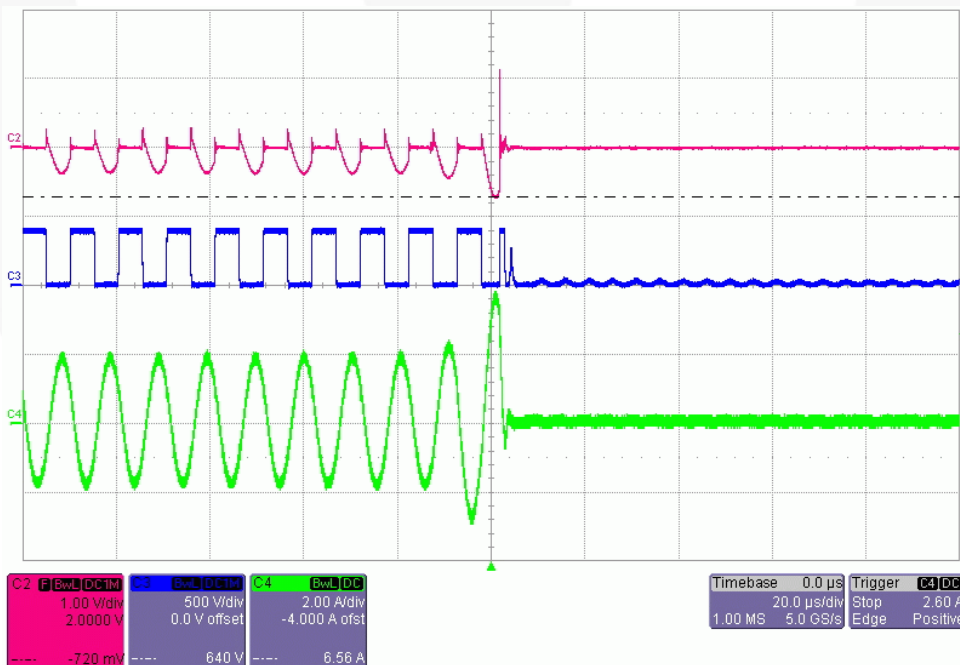

Figure 22. Protection Waveform at Output Short Condition [$V_{IN}=390V_{DC}$, ($I_O=8A \rightarrow$ Short)]
C2: Current Sensing Pin (CS) Voltage (1V/div), C3: Low-Side MOSFET V_{DS} (500V/div)
C4: Transformer Primary-Side Current (2A/div), Time: 20μs/div

2.7. Efficiency

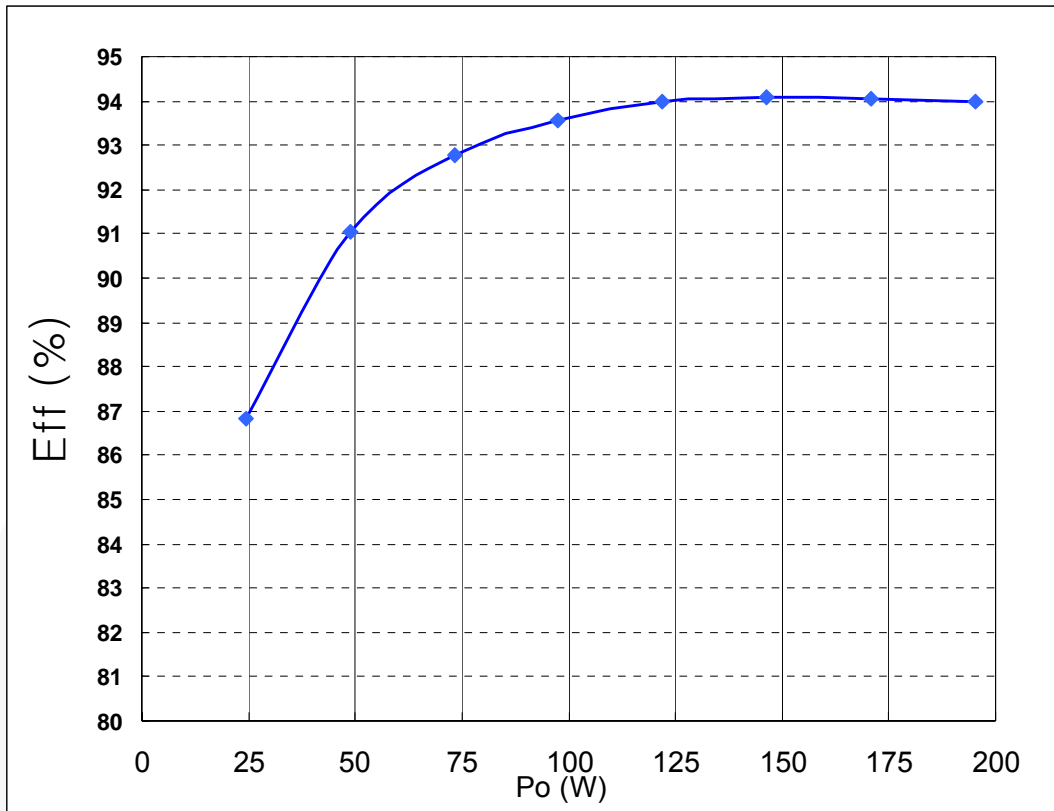



Figure 23. Measured Efficiency



TRADEMARKS

The following are registered and unregistered trademarks Fairchild Semiconductor owns or is authorized to use and is not intended to be an exhaustive list of all such trademarks.

AccuPower™
Auto-SPM™
Build it Now™
CorePLUS™
CorePOWER™
CROSSVOLT™
CTL™
Current Transfer Logic™
EcoSPARK®
EfficientMax™
EZSWITCH™*
™*
®
Fairchild®
Fairchild Semiconductor®
FACT Quiet Series™
FACT®
FAST®
FastvCore™
FETBench™
FlashWriter®

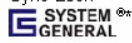
FPS™
F-PFS™
FRFET®
Global Power Resource™
Green FPS™
Green FPS™ e-Series™
Gmax™
GTO™
IntelliMAX™
ISOPLANAR™
MegaBuck™
MICROCOUPLER™
MicroFET™
MicroPak™
MillerDrive™
MotionMax™
Motion-SPM™
OPTOLOGIC®
OPTOPLANAR®
®
PDP SPM™
Power-SPM™

PowerTrench®
PowerXST™
Programmable Active Droop™
QFET®
QS™
Quiet Series™
RapidConfigure™
™
Saving our world, 1mW/W/kW at a time™
SmartMax™
SMART START™
SPM®
STEALTH™
SuperFET™
SuperSOT™-3
SuperSOT™-6
SuperSOT™-8
SupreMOS™
SyncFET™
Sync-Lock™
®*

The Power Franchise®

TinyBoost™
TinyBuck™
TinyCalc™
TinyLogic®
TINYOPTO™
TinyPower™
TinyPWM™
TinyWire™
TriFault Detect™
TRUECURRENT™*
µSerDes™

UHC®
Ultra FRFET™
UniFET™
VCX™
VisualMax™
XS™

* Trademarks of System General Corporation, used under license by Fairchild Semiconductor.

WARNING AND DISCLAIMER

Replace components on the Evaluation Board only with those parts shown on the parts list (or Bill of Materials) in the Users' Guide. Contact an authorized Fairchild representative with any questions.

The Evaluation board (or kit) is for demonstration purposes only and neither the Board nor this User's Guide constitute a sales contract or create any kind of warranty, whether express or implied, as to the applications or products involved. Fairchild warrants that its products meet Fairchild's published specifications, but does not guarantee that its products work in any specific application. Fairchild reserves the right to make changes without notice to any products described herein to improve reliability, function, or design. Either the applicable sales contract signed by Fairchild and Buyer or, if no contract exists, Fairchild's standard Terms and Conditions on the back of Fairchild invoices, govern the terms of sale of the products described herein.

DISCLAIMER

FAIRCHILD SEMICONDUCTOR RESERVES THE RIGHT TO MAKE CHANGES WITHOUT FURTHER NOTICE TO ANY PRODUCTS HEREIN TO IMPROVE RELIABILITY, FUNCTION, OR DESIGN. FAIRCHILD DOES NOT ASSUME ANY LIABILITY ARISING OUT OF THE APPLICATION OR USE OF ANY PRODUCT OR CIRCUIT DESCRIBED HEREIN; NEITHER DOES IT CONVEY ANY LICENSE UNDER ITS PATENT RIGHTS, NOR THE RIGHTS OF OTHERS.

LIFE SUPPORT POLICY

FAIRCHILD'S PRODUCTS ARE NOT AUTHORIZED FOR USE AS CRITICAL COMPONENTS IN LIFE SUPPORT DEVICES OR SYSTEMS WITHOUT THE EXPRESS WRITTEN APPROVAL OF THE PRESIDENT OF FAIRCHILD SEMICONDUCTOR CORPORATION.

As used herein:

1. Life support devices or systems are devices or systems which, (a) are intended for surgical implant into the body, or (b) support or sustain life, or (c) whose failure to perform when properly used in accordance with instructions for use provided in the labeling, can be reasonably expected to result in significant injury to the user.
2. A critical component is any component of a life support device or system whose failure to perform can be reasonably expected to cause the failure of the life support device or system, or to affect its safety or effectiveness.

ANTI-COUNTERFEITING POLICY

Fairchild Semiconductor Corporation's Anti-Counterfeiting Policy. Fairchild's Anti-Counterfeiting Policy is also stated on our external website, www.fairchildsemi.com, under Sales Support.

Counterfeiting of semiconductor parts is a growing problem in the industry. All manufacturers of semiconductor products are experiencing counterfeiting of their parts. Customers who inadvertently purchase counterfeit parts experience many problems such as loss of brand reputation, substandard performance, failed applications, and increased cost of production and manufacturing delays. Fairchild is taking strong measures to protect ourselves and our customers from the proliferation of counterfeit parts. Fairchild strongly encourages customers to purchase Fairchild parts either directly from Fairchild or from Authorized Fairchild Distributors who are listed by country on our web page cited above. Products customers buy either from Fairchild directly or from Authorized Fairchild Distributors are genuine parts, have full traceability, meet Fairchild's quality standards for handling and storage and provide access to Fairchild's full range of up-to-date technical and product information. Fairchild and our Authorized Distributors will stand behind all warranties and will appropriately address any warranty issues that may arise. Fairchild will not provide any warranty coverage or other assistance for parts bought from Unauthorized Sources. Fairchild is committed to combat this global problem and encourage our customers to do their part in stopping this practice by buying direct or from authorized distributors.