

FDP7N50/FDPF7N50

500V N-Channel MOSFET

Features

- 7A, 500V, $R_{DS(on)} = 0.9\Omega @ V_{GS} = 10V$
- Low gate charge (typical 12.8 nC)
- Low C_{rss} (typical 9 pF)
- Fast switching
- 100% avalanche tested
- Improved dv/dt capability

Description

These N-Channel enhancement mode power field effect transistors are produced using Fairchild's proprietary, planar stripe, DMOS technology.

This advanced technology has been especially tailored to minimize on-state resistance, provide superior switching performance, and withstand high energy pulse in the avalanche and commutation mode. These devices are well suited for high efficient switched mode power supplies and active power factor correction.

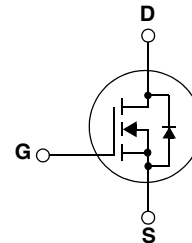
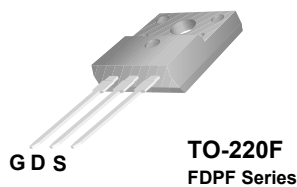
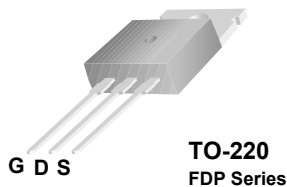

Absolute Maximum Ratings

Symbol	Parameter	FDP7N50	FDPF7N50	Unit
V_{DSS}	Drain-Source Voltage	500		V
I_D	Drain Current - Continuous ($T_C = 25^\circ\text{C}$) - Continuous ($T_C = 100^\circ\text{C}$)	7	7 *	A
		4.2	4.2 *	A
I_{DM}	Drain Current - Pulsed (Note 1)	28	28 *	A
V_{GSS}	Gate-Source voltage	± 30		V
E_{AS}	Single Pulsed Avalanche Energy (Note 2)	270		mJ
I_{AR}	Avalanche Current (Note 1)	7		A
E_{AR}	Repetitive Avalanche Energy (Note 1)	8.9		mJ
dv/dt	Peak Diode Recovery dv/dt (Note 3)	4.5		V/ns
P_D	Power Dissipation ($T_C = 25^\circ\text{C}$) - Derate above 25°C	89	39	W
		0.71	0.31	W/ $^\circ\text{C}$
T_J, T_{STG}	Operating and Storage Temperature Range	-55 to +150		$^\circ\text{C}$
T_L	Maximum Lead Temperature for Soldering Purpose, 1/8" from Case for 5 Seconds	300		$^\circ\text{C}$

* Drain current limited by maximum junction temperature.

Thermal Characteristics

Symbol	Parameter	FDP7N50	FDPF7N50	Unit
$R_{\theta JC}$	Thermal Resistance, Junction-to-Case	1.4	3.2	$^\circ\text{C}/\text{W}$
$R_{\theta CS}$	Thermal Resistance, Case-to-Sink Typ.	0.5	--	$^\circ\text{C}/\text{W}$
$R_{\theta JA}$	Thermal Resistance, Junction-to-Ambient	62.5	62.5	$^\circ\text{C}/\text{W}$

Package Marking and Ordering Information

Device Marking	Device	Package	Reel Size	Tape Width	Quantity
FDP7N50	FDP7N50	TO-220	--	--	50
FDPF7N50	FDPF7N50	TO-220F	--	--	50

Electrical Characteristics T_C = 25°C unless otherwise noted

Symbol	Parameter	Conditions	Min.	Typ.	Max	Units
Off Characteristics						
BV _{DSS}	Drain-Source Breakdown Voltage	V _{GS} = 0V, I _D = 250μA	500	--	--	V
ΔBV _{DSS} / ΔT _J	Breakdown Voltage Temperature Coefficient	I _D = 250μA, Referenced to 25°C	--	0.5	--	V/°C
I _{DSS}	Zero Gate Voltage Drain Current	V _{DS} = 500V, V _{GS} = 0V V _{DS} = 400V, T _C = 125°C	--	--	1 10	μA μA
I _{GSSF}	Gate-Body Leakage Current, Forward	V _{GS} = 30V, V _{DS} = 0V	--	--	100	nA
I _{GSSR}	Gate-Body Leakage Current, Reverse	V _{GS} = -30V, V _{DS} = 0V	--	--	-100	nA
On Characteristics						
V _{GS(th)}	Gate Threshold Voltage	V _{DS} = V _{GS} , I _D = 250μA	3.0	--	5.0	V
R _{DS(on)}	Static Drain-Source On-Resistance	V _{GS} = 10V, I _D = 3.5A	--	0.76	0.9	Ω
g _{FS}	Forward Transconductance	V _{DS} = 40V, I _D = 3.5A (Note 4)	--	2.5	--	S
Dynamic Characteristics						
C _{iss}	Input Capacitance	V _{DS} = 25V, V _{GS} = 0V, f = 1.0MHz	--	720	940	pF
C _{oss}	Output Capacitance		--	95	190	pF
C _{rss}	Reverse Transfer Capacitance		--	9	13.5	pF
Switching Characteristics						
t _{d(on)}	Turn-On Delay Time	V _{DD} = 250V, I _D = 7A R _G = 25Ω (Note 4, 5)	--	6	20	ns
t _r	Turn-On Rise Time		--	55	120	ns
t _{d(off)}	Turn-Off Delay Time		--	25	60	ns
t _f	Turn-Off Fall Time		--	35	80	ns
Q _g	Total Gate Charge	V _{DS} = 400V, I _D = 7A V _{GS} = 10V (Note 4, 5)	--	12.8	16.6	nC
Q _{gs}	Gate-Source Charge		--	3.7	--	nC
Q _{gd}	Gate-Drain Charge		--	5.8	--	nC
Drain-Source Diode Characteristics and Maximum Ratings						
I _S	Maximum Continuous Drain-Source Diode Forward Current		--	--	7	A
I _{SM}	Maximum Pulsed Drain-Source Diode Forward Current		--	--	28	A
V _{SD}	Drain-Source Diode Forward Voltage	V _{GS} = 0V, I _S = 7A	--	--	1.4	V
t _{rr}	Reverse Recovery Time	V _{GS} = 0V, I _S = 7A di _F /dt = 100A/μs (Note 4)	--	275	--	ns
Q _{rr}	Reverse Recovery Charge		--	0.04	--	μC

NOTES:

1. Repetitive Rating: Pulse width limited by maximum junction temperature
2. I_{AS} = 7A, V_{DD} = 50V, L = 10mH, R_G = 25Ω, Starting T_J = 25°C
3. I_{SD} ≤ 7A, di/dt ≤ 200A/μs, V_{DD} ≤ BV_{DSS}, Starting T_J = 25°C
4. Pulse Test: Pulse width ≤ 300μs, Duty Cycle ≤ 2%
5. Essentially Independent of Operating Temperature Typical Characteristics

Typical Performance Characteristics

Figure 1. On-Region Characteristics

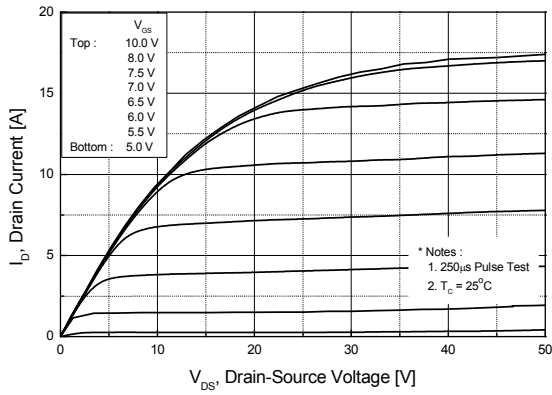

Figure 2. Transfer Characteristics

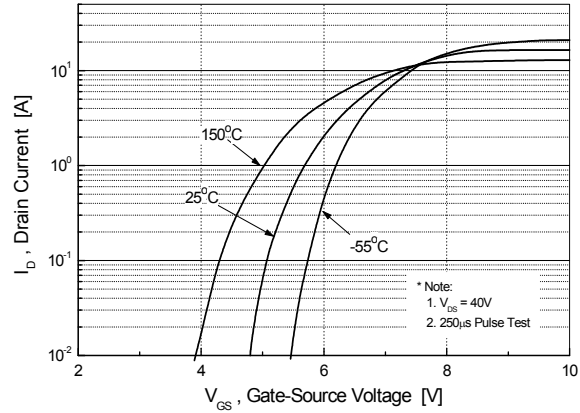

Figure 3. On-Resistance Variation vs. Drain Current and Gate Voltage

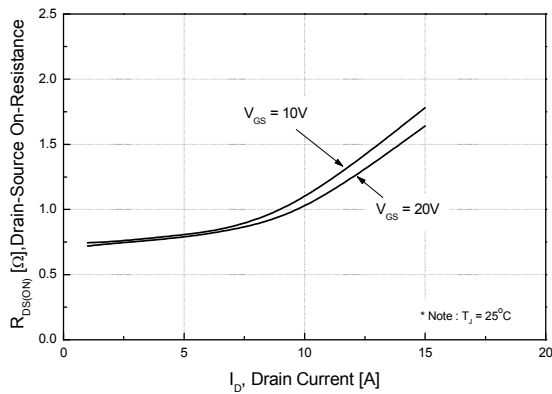

Figure 4. Body Diode Forward Voltage Variation vs. Source Current and Temperature

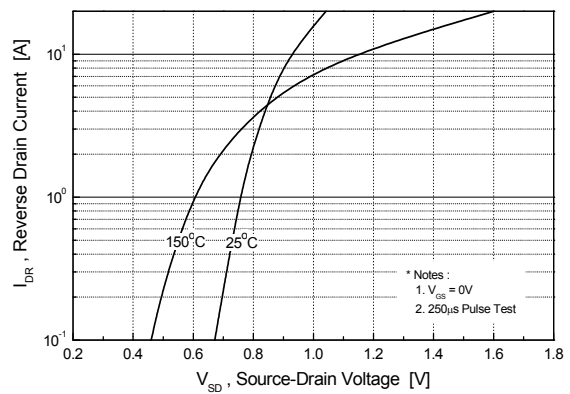

Figure 5. Capacitance Characteristics

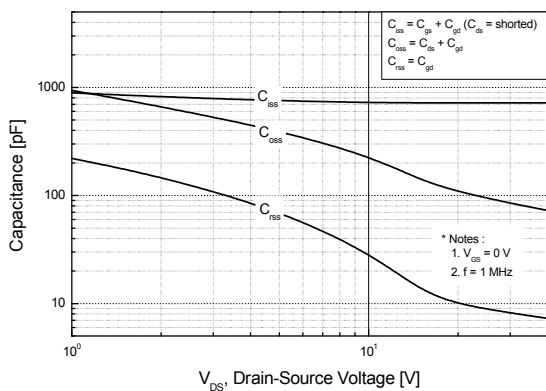
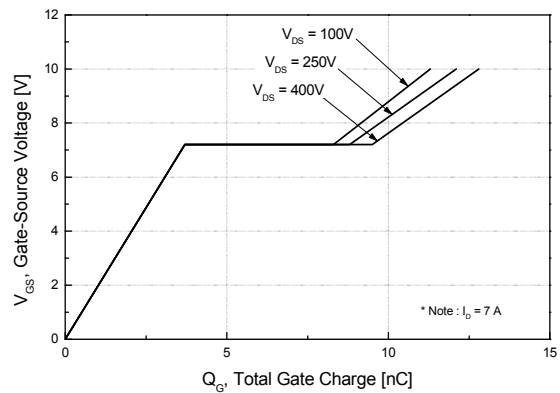

Figure 6. Gate Charge Characteristics



Typical Performance Characteristics (Continued)

Figure 7. Breakdown Voltage Variation vs. Temperature

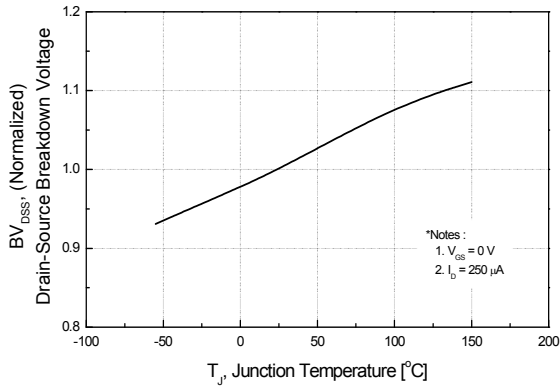

Figure 8. On-Resistance Variation vs. Temperature

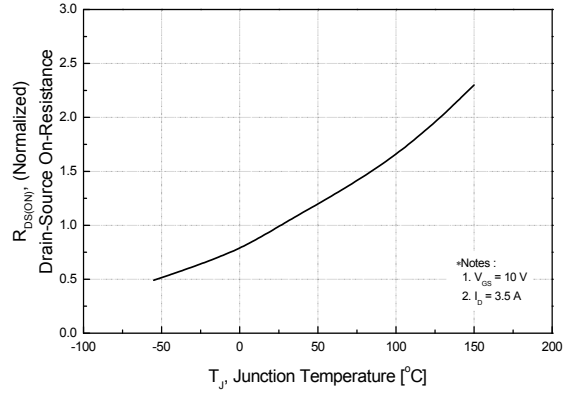

Figure 9-1. Maximum Safe Operating Area - FDP7N50

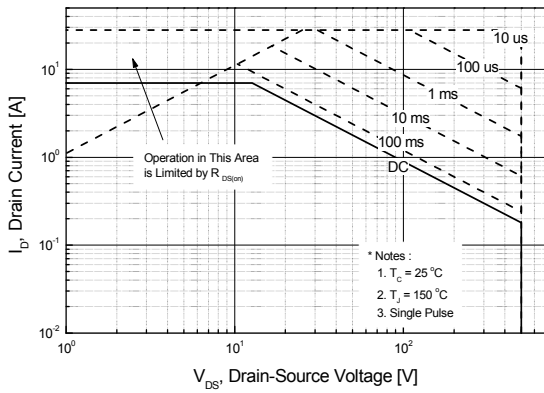

Figure 9-2. Maximum Safe Operating Area - FDPF7N50

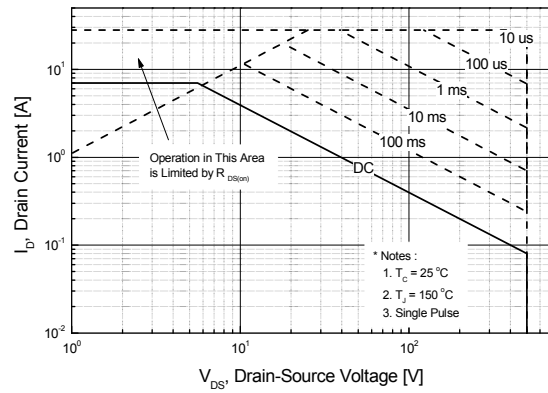

Figure 10. Maximum Drain Current Vs. Case Temperature

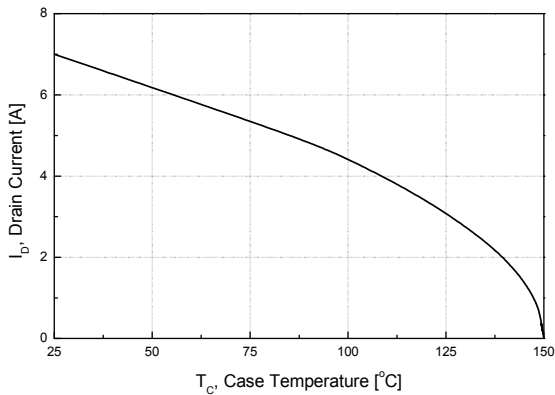

Figure 11-1. Transient Thermal Response Curve - FDP7N50

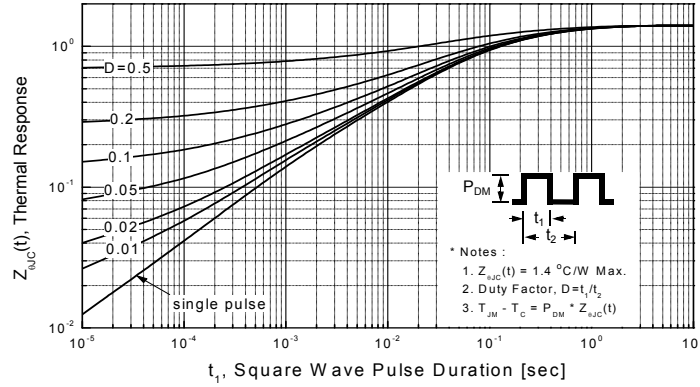
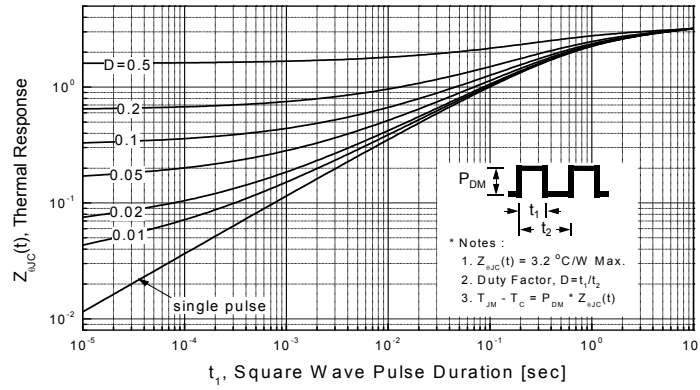
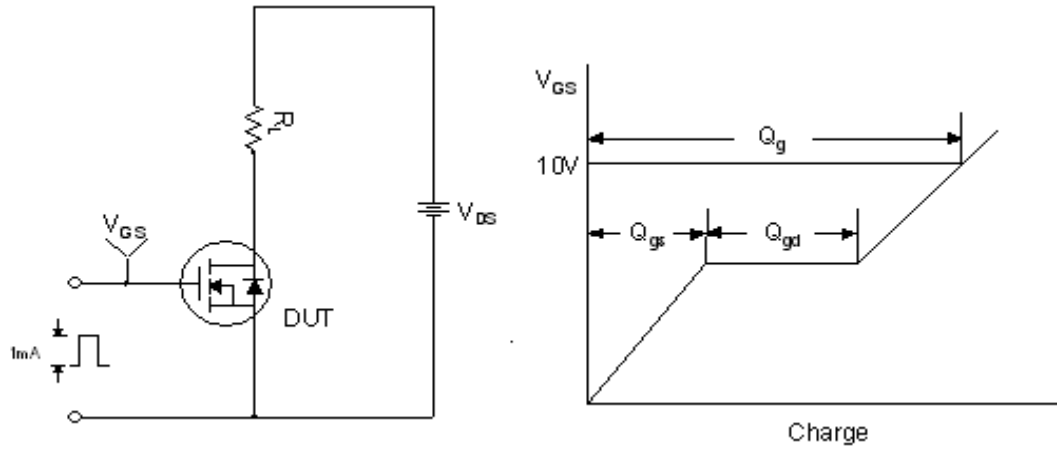

Figure 11-2. Transient Thermal Response Curve - FDPF7N50



Gate Charge Test Circuit & Waveform



Resistive Switching Test Circuit & Waveforms

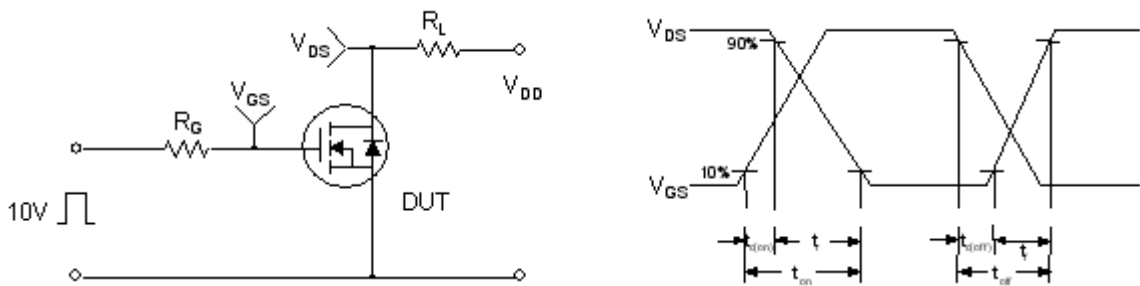

Unclamped Inductive Switching Test Circuit & Waveforms

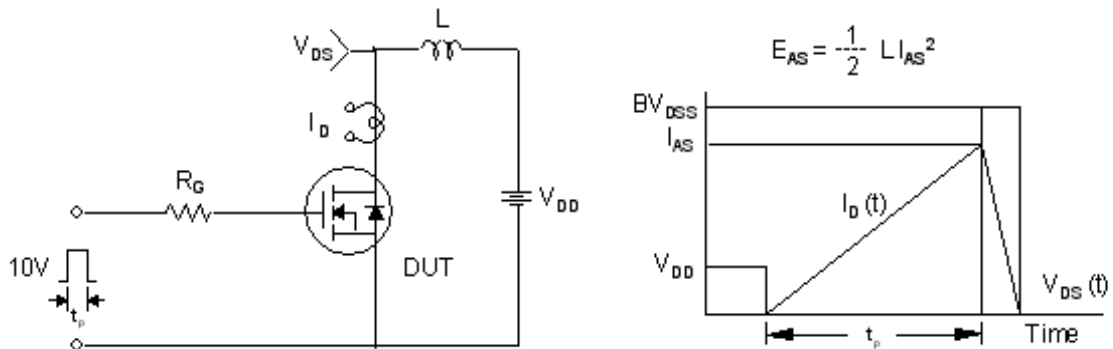

Peak Diode Recovery dv/dt Test Circuit & Waveforms



Mechanical Dimensions

TO-220

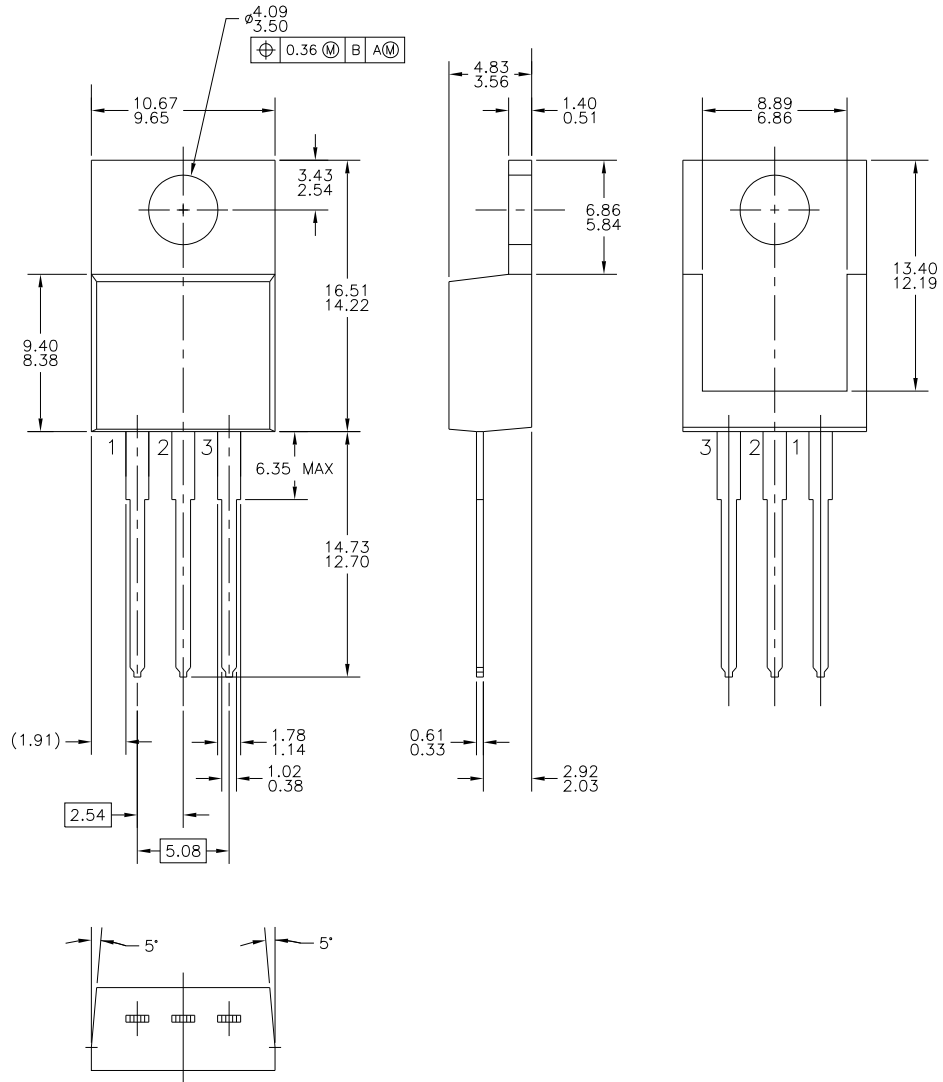

Dimensions in Millimeters

Mechanical Dimensions (Continued)

TO-220F

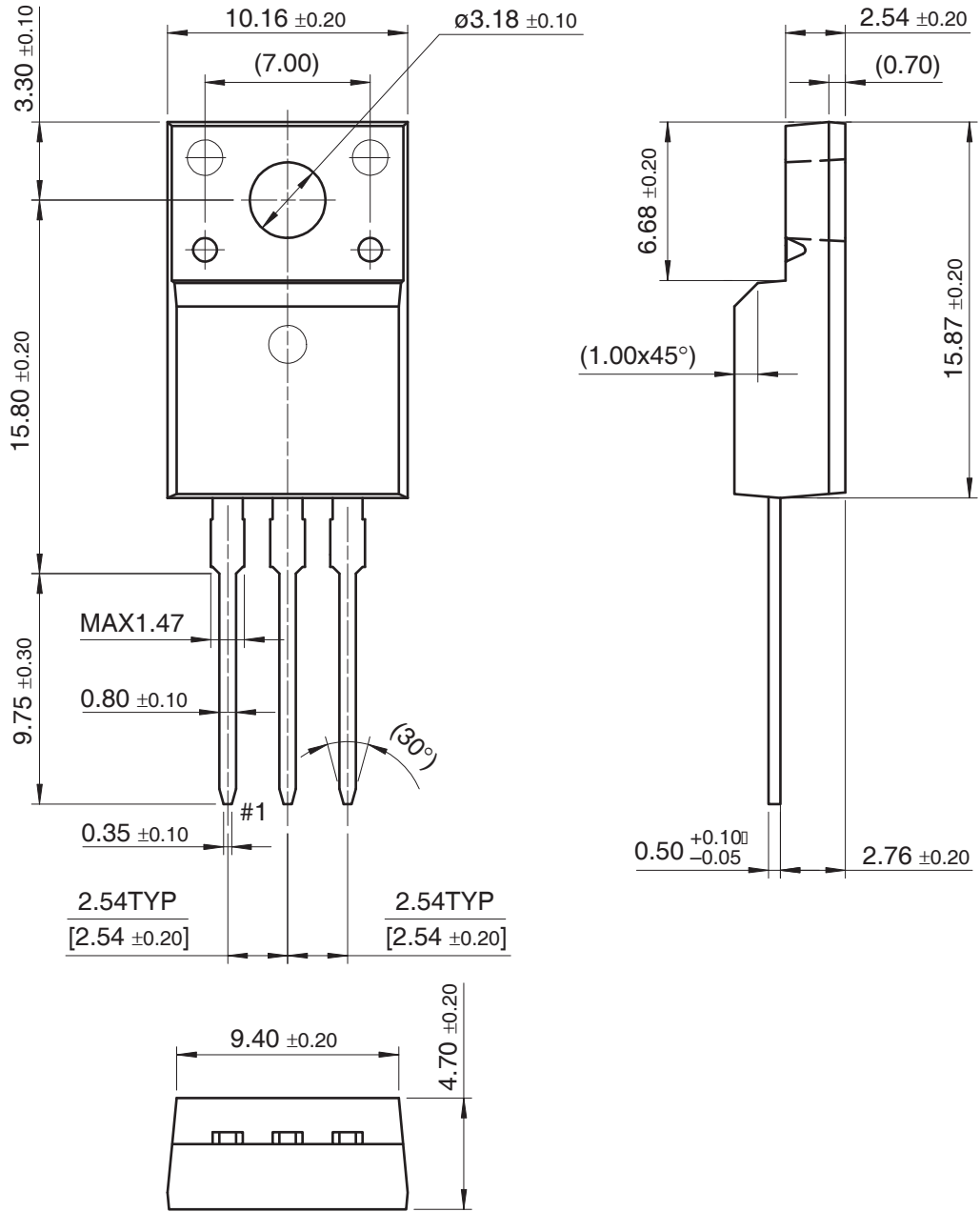

Dimensions in Millimeters



TRADEMARKS

The following are registered and unregistered trademarks Fairchild Semiconductor owns or is authorized to use and is not intended to be an exhaustive list of all such trademarks.

ACEx®	HiSeC™	Programmable Active Droop™	TinyLogic®
Across the board. Around the world.™	i-Lo™	QFET®	TINYOPTO™
ActiveArray™	ImpliedDisconnect™	QS™	TinyPower™
Bottomless™	IntelliMAX™	QT Optoelectronics™	TinyWire™
Build it Now™	ISOPLANAR™	Quiet Series™	TruTranslation™
CoolFET™	MICROCOUPLER™	RapidConfigure™	µSerDes™
CROSSVOLT™	MicroPak™	RapidConnect™	UHC®
CTL™	MICROWIRE™	ScalarPump™	UniFET™
Current Transfer Logic™	MSX™	SMART START™	VCX™
DOME™	MSXPro™	SPM®	Wire™
E ² CMOS™	OCX™	STEALTH™	
EcoSPARK®	OCXPro™	SuperFET™	
EnSigna™	OPTOLOGIC®	SuperSOT™-3	
FACT Quiet Series™	OPTOPLANAR®	SuperSOT™-6	
FACT®	PACMAN™	SuperSOT™-8	
FAST®	POP™	SyncFET™	
FASTr™	Power220®	TCM™	
FPS™	Power247®	The Power Franchise®	
FRFET®	PowerEdge™	⏻™	
GlobalOptoisolator™	PowerSaver™	TinyBoost™	
GTO™	PowerTrench®	TinyBuck™	

DISCLAIMER

FAIRCHILD SEMICONDUCTOR RESERVES THE RIGHT TO MAKE CHANGES WITHOUT FURTHER NOTICE TO ANY PRODUCTS HEREIN TO IMPROVE RELIABILITY, FUNCTION OR DESIGN. FAIRCHILD DOES NOT ASSUME ANY LIABILITY ARISING OUT OF THE APPLICATION OR USE OF ANY PRODUCT OR CIRCUIT DESCRIBED HEREIN; NEITHER DOES IT CONVEY ANY LICENSE UNDER ITS PATENT RIGHTS, NOR THE RIGHTS OF OTHERS. THESE SPECIFICATIONS DO NOT EXPAND THE TERMS OF FAIRCHILD'S WORLDWIDE TERMS AND CONDITIONS, SPECIFICALLY THE WARRANTY THEREIN, WHICH COVERS THESE PRODUCTS.

LIFE SUPPORT POLICY

FAIRCHILD'S PRODUCTS ARE NOT AUTHORIZED FOR USE AS CRITICAL COMPONENTS IN LIFE SUPPORT DEVICES OR SYSTEMS WITHOUT THE EXPRESS WRITTEN APPROVAL OF FAIRCHILD SEMICONDUCTOR CORPORATION.

As used herein:

- Life support devices or systems are devices or systems which, (a) are intended for surgical implant into the body or (b) support or sustain life, and (c) whose failure to perform when properly used in accordance with instructions for use provided in the labeling, can be reasonably expected to result in a significant injury of the user.
- A critical component in any component of a life support, device, or system whose failure to perform can be reasonably expected to cause the failure of the life support device or system, or to affect its safety or effectiveness.

PRODUCT STATUS DEFINITIONS

Definition of Terms

Datasheet Identification	Product Status	Definition
Advance Information	Formative or In Design	This datasheet contains the design specifications for product development. Specifications may change in any manner without notice.
Preliminary	First Production	This datasheet contains preliminary data; supplementary data will be published at a later date. Fairchild Semiconductor reserves the right to make changes at any time without notice to improve design.
No Identification Needed	Full Production	This datasheet contains final specifications. Fairchild Semiconductor reserves the right to make changes at any time without notice to improve design.
Obsolete	Not In Production	This datasheet contains specifications on a product that has been discontinued by Fairchild Semiconductor. The datasheet is printed for reference information only.

Rev. I24