

FDMS2506SDC

N-Channel Dual Cool™ PowerTrench® SyncFET™ 25 V, 49 A, 1.45 mΩ

Features

- Dual Cool™ Top Side Cooling PQFN package
- Max $r_{DS(on)}$ = 1.45 mΩ at $V_{GS} = 10\text{ V}$, $I_D = 30\text{ A}$
- Max $r_{DS(on)}$ = 2.1 mΩ at $V_{GS} = 4.5\text{ V}$, $I_D = 26\text{ A}$
- High performance technology for extremely low $r_{DS(on)}$
- SyncFET Schottky Body Diode
- RoHS Compliant

General Description

This N-Channel MOSFET is produced using Fairchild Semiconductor's advanced PowerTrench® process. Advancements in both silicon and Dual Cool™ package technologies have been combined to offer the lowest $r_{DS(on)}$ while maintaining excellent switching performance by extremely low Junction-to-Ambient thermal resistance. This device has the added benefit of an efficient monolithic Schottky body diode.

Applications

- Synchronous Rectifier for DC/DC Converters
- Telecom Secondary Side Rectification
- High End Server/Workstation Vcore Low Side

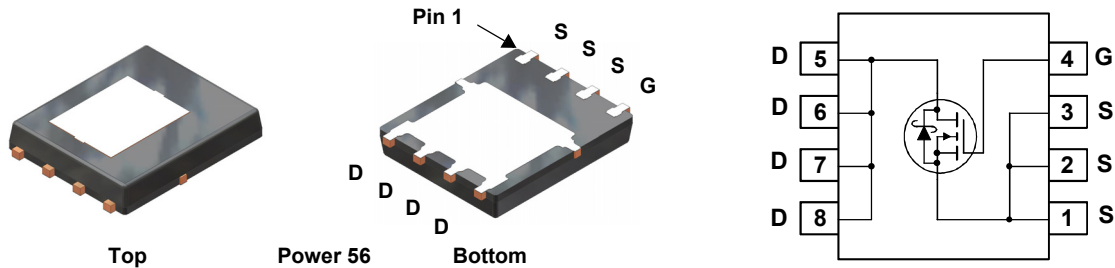

MOSFET Maximum Ratings $T_A = 25^\circ\text{C}$ unless otherwise noted

| Symbol | Parameter | Rated | Units |
|----------------|--|-------------|------------------|
| V_{DS} | Drain to Source Voltage | 25 | V |
| V_{GS} | Gate to Source Voltage (Note 4) | ±20 | V |
| I_D | Drain Current -Continuous (Package limited) $T_C = 25^\circ\text{C}$ | 49 | A |
| | -Continuous (Silicon limited) $T_C = 25^\circ\text{C}$ | 202 | |
| | -Continuous $T_A = 25^\circ\text{C}$ (Note 1a) | 39 | |
| | -Pulsed | 200 | |
| E_{AS} | Single Pulse Avalanche Energy (Note 3) | 220 | mJ |
| dv/dt | Peak Diode Recovery dv/dt (Note 5) | 1.6 | V/ns |
| P_D | Power Dissipation $T_C = 25^\circ\text{C}$ | 89 | W |
| | Power Dissipation $T_A = 25^\circ\text{C}$ (Note 1a) | 3.3 | |
| T_J, T_{STG} | Operating and Storage Junction Temperature Range | -55 to +150 | $^\circ\text{C}$ |

Thermal Characteristics

| | | | |
|-----------------|---|-----|--------------------|
| $R_{\theta JC}$ | Thermal Resistance, Junction to Case (Top Source) | 2.7 | $^\circ\text{C/W}$ |
| $R_{\theta JC}$ | Thermal Resistance, Junction to Case (Bottom Drain) | 1.4 | |
| $R_{\theta JA}$ | Thermal Resistance, Junction to Ambient (Note 1a) | 38 | |
| $R_{\theta JA}$ | Thermal Resistance, Junction to Ambient (Note 1b) | 81 | |
| $R_{\theta JA}$ | Thermal Resistance, Junction to Ambient (Note 1i) | 16 | |
| $R_{\theta JA}$ | Thermal Resistance, Junction to Ambient (Note 1j) | 23 | |
| $R_{\theta JA}$ | Thermal Resistance, Junction to Ambient (Note 1k) | 11 | |

Package Marking and Ordering Information

| Device Marking | Device | Package | Reel Size | Tape Width | Quantity |
|----------------|-------------|---------------------|-----------|------------|------------|
| 2506S | FDMS2506SDC | Dual Cool™ Power 56 | 13" | 12 mm | 3000 units |

Electrical Characteristics $T_J = 25\text{ }^\circ\text{C}$ unless otherwise noted

| Symbol | Parameter | Test Conditions | Min | Typ | Max | Units |
|--------|-----------|-----------------|-----|-----|-----|-------|
|--------|-----------|-----------------|-----|-----|-----|-------|

Off Characteristics

| | | | | | | |
|--------------------------------------|---|---|----|----|-----|----------------------|
| BV_{DSS} | Drain to Source Breakdown Voltage | $I_D = 1\text{ mA}, V_{GS} = 0\text{ V}$ | 25 | | | V |
| $\frac{\Delta BV_{DSS}}{\Delta T_J}$ | Breakdown Voltage Temperature Coefficient | $I_D = 10\text{ mA}$, referenced to $25\text{ }^\circ\text{C}$ | | 21 | | mV/ $^\circ\text{C}$ |
| I_{DSS} | Zero Gate Voltage Drain Current | $V_{DS} = 20\text{ V}, V_{GS} = 0\text{ V}$ | | | 500 | μA |
| I_{GSS} | Gate to Source Leakage Current, Forward | $V_{GS} = 20\text{ V}, V_{DS} = 0\text{ V}$ | | | 100 | nA |

On Characteristics

| | | | | | | |
|--|--|--|-----|-----|------|----------------------|
| $V_{GS(th)}$ | Gate to Source Threshold Voltage | $V_{GS} = V_{DS}, I_D = 1\text{ mA}$ | 1.2 | 1.7 | 3.0 | V |
| $\frac{\Delta V_{GS(th)}}{\Delta T_J}$ | Gate to Source Threshold Voltage Temperature Coefficient | $I_D = 10\text{ mA}$, referenced to $25\text{ }^\circ\text{C}$ | | -5 | | mV/ $^\circ\text{C}$ |
| $r_{DS(on)}$ | Static Drain to Source On Resistance | $V_{GS} = 10\text{ V}, I_D = 30\text{ A}$ | | 1.2 | 1.45 | m Ω |
| | | $V_{GS} = 4.5\text{ V}, I_D = 26\text{ A}$ | | 1.6 | 2.1 | |
| | | $V_{GS} = 10\text{ V}, I_D = 30\text{ A}, T_J = 125\text{ }^\circ\text{C}$ | | 1.6 | 2.0 | |
| g_{FS} | Forward Transconductance | $V_{DS} = 5\text{ V}, I_D = 30\text{ A}$ | | 171 | | S |

Dynamic Characteristics

| | | | | | | |
|------------|------------------------------|--|--|------|------|----------|
| C_{iss} | Input Capacitance | $V_{DS} = 13\text{ V}, V_{GS} = 0\text{ V},$ $f = 1\text{ MHz}$ | | 4470 | 5945 | pF |
| C_{oss} | Output Capacitance | | | 1200 | 1560 | pF |
| C_{riss} | Reverse Transfer Capacitance | | | 244 | 370 | pF |
| R_g | Gate Resistance | | | 0.8 | 1.8 | Ω |

Switching Characteristics

| | | | | | | | |
|--------------|-------------------------------|---|---------------------------------------|------|----|----|----|
| $t_{d(on)}$ | Turn-On Delay Time | $V_{DD} = 13\text{ V}, I_D = 30\text{ A},$ $V_{GS} = 10\text{ V}, R_{GEN} = 6\text{ }\Omega$ | | 16 | 29 | ns | |
| t_r | Rise Time | | | 7.4 | 15 | ns | |
| $t_{d(off)}$ | Turn-Off Delay Time | | | 41 | 66 | ns | |
| t_f | Fall Time | | | 4.8 | 10 | ns | |
| Q_g | Total Gate Charge | | $V_{GS} = 0\text{ V to }10\text{ V}$ | | 66 | 93 | nC |
| Q_g | Total Gate Charge | | $V_{GS} = 0\text{ V to }4.5\text{ V}$ | | 30 | 43 | nC |
| Q_{gs} | Gate to Source Gate Charge | $V_{DD} = 13\text{ V},$ $I_D = 30\text{ A}$ | | 13.4 | | nC | |
| Q_{gd} | Gate to Drain "Miller" Charge | | | 7.5 | | nC | |

Drain-Source Diode Characteristics

| | | | | | | |
|----------|---------------------------------------|---|--|------|-----|----|
| V_{SD} | Source to Drain Diode Forward Voltage | $V_{GS} = 0\text{ V}, I_S = 2\text{ A}$ (Note 2) | | 0.40 | 0.7 | V |
| | | $V_{GS} = 0\text{ V}, I_S = 30\text{ A}$ (Note 2) | | 0.76 | 1.2 | |
| t_{rr} | Reverse Recovery Time | $I_F = 30\text{ A}, di/dt = 300\text{ A}/\mu\text{s}$ | | 35 | 56 | ns |
| Q_{rr} | Reverse Recovery Charge | | | 39 | 63 | nC |

Thermal Characteristics

| | | | |
|-----------------|---|-----|-----------------------------|
| $R_{\theta JC}$ | Thermal Resistance, Junction to Case (Top Source) | 2.7 | $^{\circ}\text{C}/\text{W}$ |
| $R_{\theta JC}$ | Thermal Resistance, Junction to Case (Bottom Drain) | 1.4 | |
| $R_{\theta JA}$ | Thermal Resistance, Junction to Ambient (Note 1a) | 38 | |
| $R_{\theta JA}$ | Thermal Resistance, Junction to Ambient (Note 1b) | 81 | |
| $R_{\theta JA}$ | Thermal Resistance, Junction to Ambient (Note 1c) | 27 | |
| $R_{\theta JA}$ | Thermal Resistance, Junction to Ambient (Note 1d) | 34 | |
| $R_{\theta JA}$ | Thermal Resistance, Junction to Ambient (Note 1e) | 16 | |
| $R_{\theta JA}$ | Thermal Resistance, Junction to Ambient (Note 1f) | 19 | |
| $R_{\theta JA}$ | Thermal Resistance, Junction to Ambient (Note 1g) | 26 | |
| $R_{\theta JA}$ | Thermal Resistance, Junction to Ambient (Note 1h) | 61 | |
| $R_{\theta JA}$ | Thermal Resistance, Junction to Ambient (Note 1i) | 16 | |
| $R_{\theta JA}$ | Thermal Resistance, Junction to Ambient (Note 1j) | 23 | |
| $R_{\theta JA}$ | Thermal Resistance, Junction to Ambient (Note 1k) | 11 | |
| $R_{\theta JA}$ | Thermal Resistance, Junction to Ambient (Note 1l) | 13 | |

NOTES:

- $R_{\theta JA}$ is determined with the device mounted on a FR-4 board using a specified pad of 2 oz copper as shown below. $R_{\theta JC}$ is guaranteed by design while $R_{\theta CA}$ is determined by the user's board design.

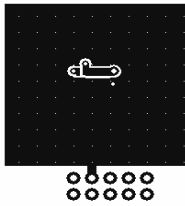

a. 38 $^{\circ}\text{C}/\text{W}$ when mounted on a 1 in² pad of 2 oz copper



b. 81 $^{\circ}\text{C}/\text{W}$ when mounted on a minimum pad of 2 oz copper

- Still air, 20.9x10.4x12.7mm Aluminum Heat Sink, 1 in² pad of 2 oz copper
 - Still air, 20.9x10.4x12.7mm Aluminum Heat Sink, minimum pad of 2 oz copper
 - Still air, 45.2x41.4x11.7mm Aavid Thermalloy Part # 10-L41B-11 Heat Sink, 1 in² pad of 2 oz copper
 - Still air, 45.2x41.4x11.7mm Aavid Thermalloy Part # 10-L41B-11 Heat Sink, minimum pad of 2 oz copper
 - 200FPM Airflow, No Heat Sink, 1 in² pad of 2 oz copper
 - 200FPM Airflow, No Heat Sink, minimum pad of 2 oz copper
 - 200FPM Airflow, 20.9x10.4x12.7mm Aluminum Heat Sink, 1 in² pad of 2 oz copper
 - 200FPM Airflow, 20.9x10.4x12.7mm Aluminum Heat Sink, minimum pad of 2 oz copper
 - 200FPM Airflow, 45.2x41.4x11.7mm Aavid Thermalloy Part # 10-L41B-11 Heat Sink, 1 in² pad of 2 oz copper
 - 200FPM Airflow, 45.2x41.4x11.7mm Aavid Thermalloy Part # 10-L41B-11 Heat Sink, minimum pad of 2 oz copper
- Pulse Test: Pulse Width < 300 μs , Duty cycle < 2.0%.
 - E_{AS} of 220 mJ is based on starting $T_J = 25^{\circ}\text{C}$, $L = 1$ mH, $I_{AS} = 21$ A, $V_{DD} = 23$ V, $V_{GS} = 10$ V. 100% test at $L = 0.3$ mH, $I_{AS} = 32$ A.
 - As an N-ch device, the negative V_{GS} rating is for low duty cycle pulse occurrence only. No continuous rating is implied.
 - $I_{SD} \leq 30$ A, $di/dt \leq 200$ A/ μs , $V_{DD} \leq BV_{DSS}$, Starting $T_J = 25^{\circ}\text{C}$.

Typical Characteristics $T_J = 25\text{ }^\circ\text{C}$ unless otherwise noted

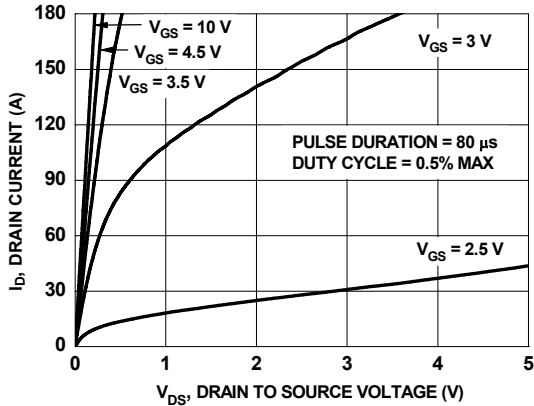

Figure 1. On-Region Characteristics

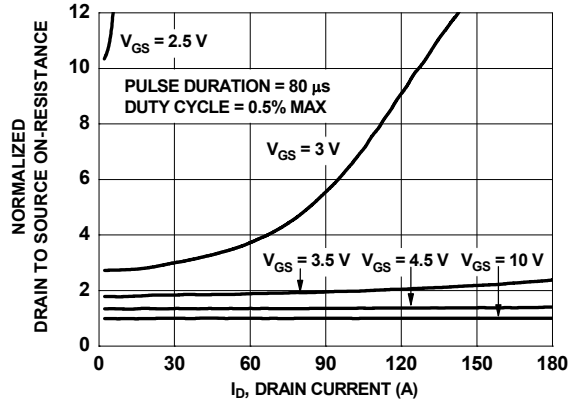

Figure 2. Normalized On-Resistance vs Drain Current and Gate Voltage

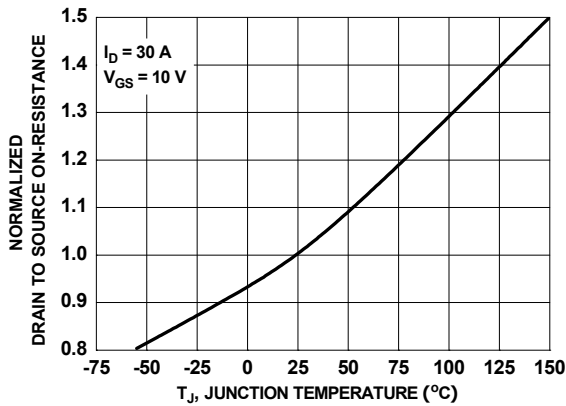

Figure 3. Normalized On-Resistance vs Junction Temperature

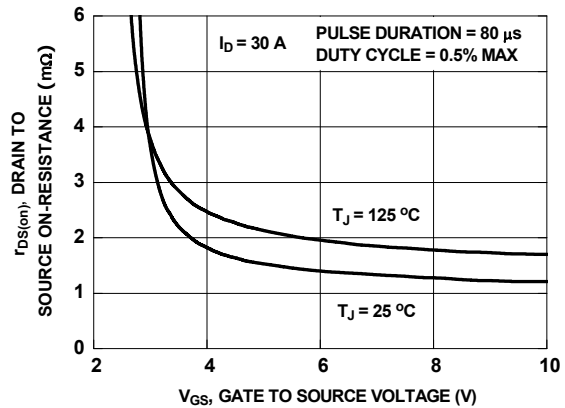

Figure 4. On-Resistance vs Gate to Source Voltage

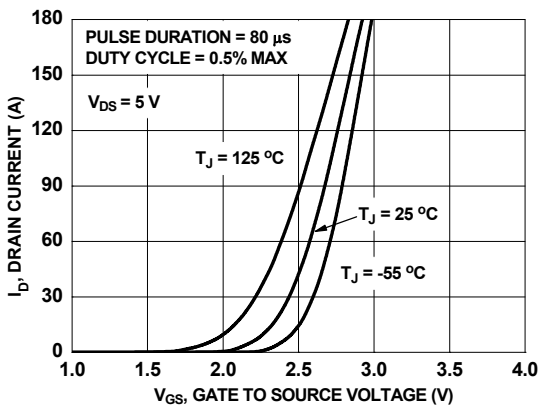

Figure 5. Transfer Characteristics

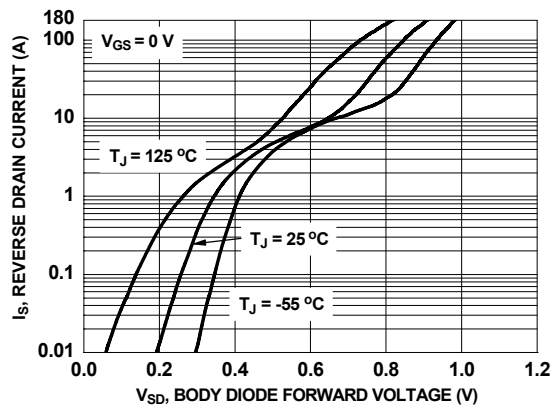

Figure 6. Source to Drain Diode Forward Voltage vs Source Current

Typical Characteristics $T_J = 25^\circ\text{C}$ unless otherwise noted

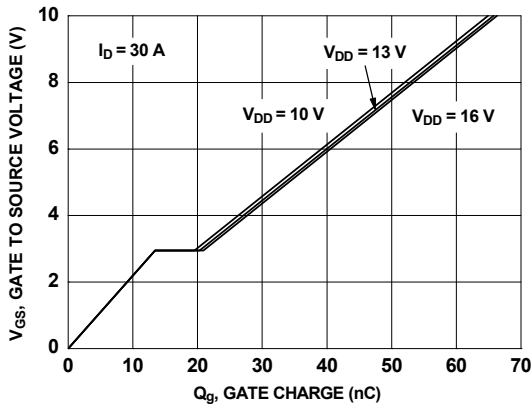

Figure 7. Gate Charge Characteristics

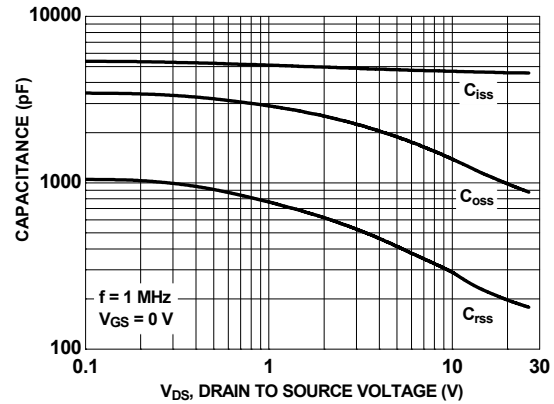

Figure 8. Capacitance vs Drain to Source Voltage

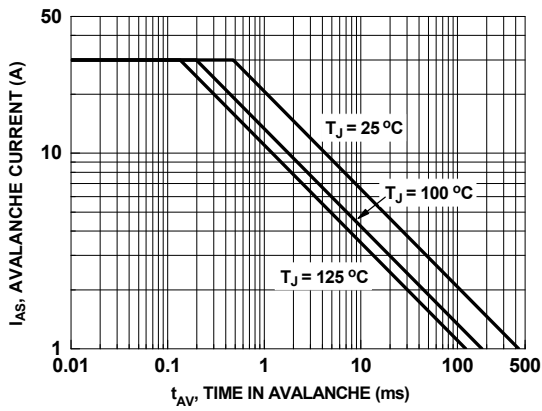

Figure 9. Unclamped Inductive Switching Capability

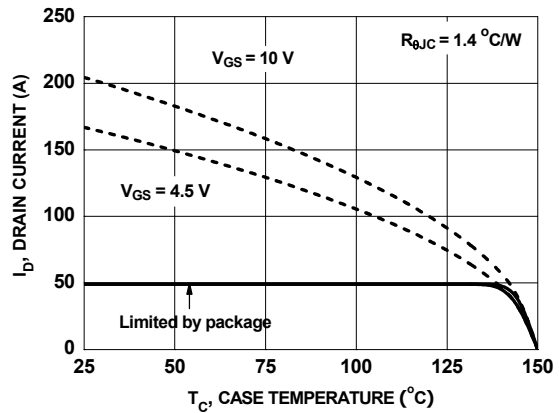

Figure 10. Maximum Continuous Drain Current vs Case Temperature

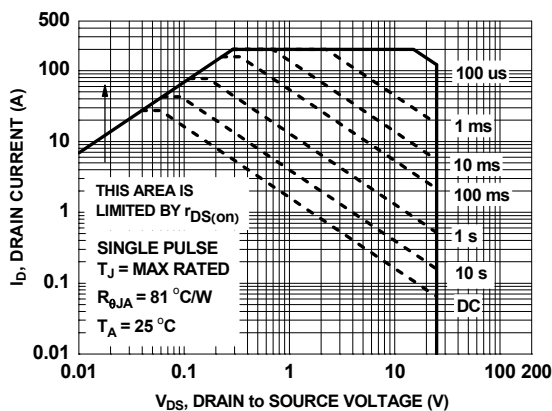

Figure 11. Forward Bias Safe Operating Area

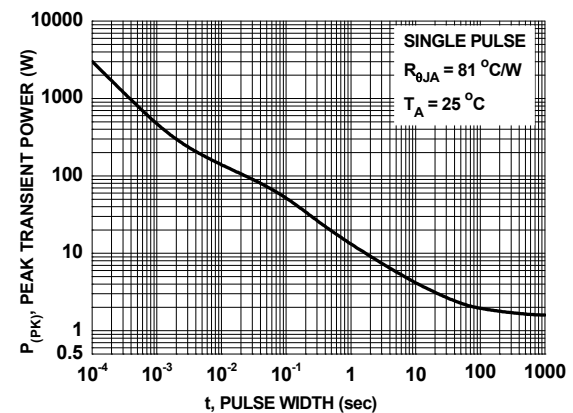

Figure 12. Single Pulse Maximum Power Dissipation

Typical Characteristics $T_J = 25\text{ }^\circ\text{C}$ unless otherwise noted

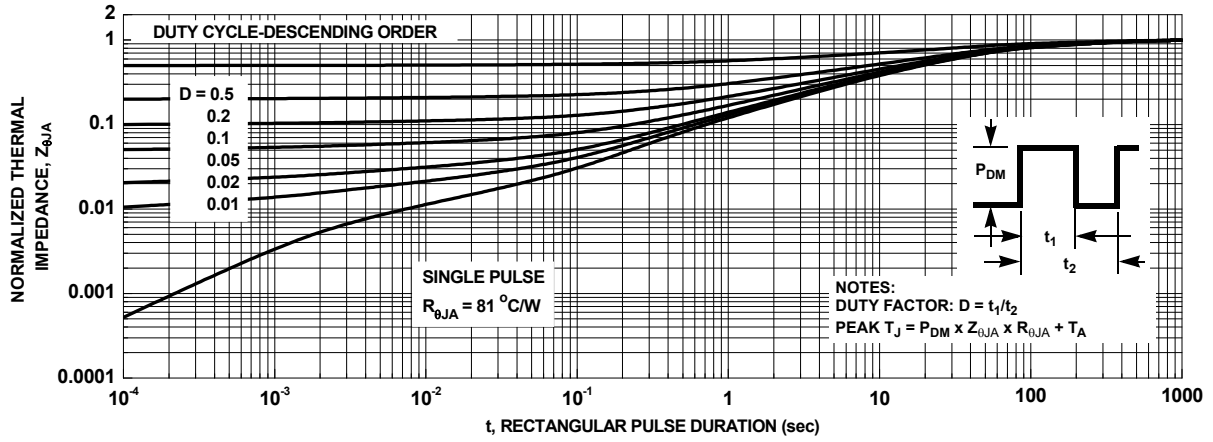

Figure 13. Junction-to-Ambient Transient Thermal Response Curve

Typical Characteristics (continued)

SyncFET Schottky body diode Characteristics

Fairchild's SyncFET process embeds a Schottky diode in parallel with PowerTrench MOSFET. This diode exhibits similar characteristics to a discrete external Schottky diode in parallel with a MOSFET. Figure 14 shows the reverse recovery characteristic of the FDMS2506SDC.

Schottky barrier diodes exhibit significant leakage at high temperature and high reverse voltage. This will increase the power in the device.

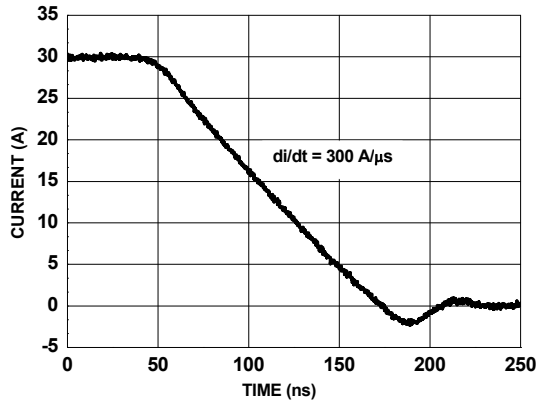

Figure 14. FDMS2506SDC SyncFET body diode reverse recovery characteristic

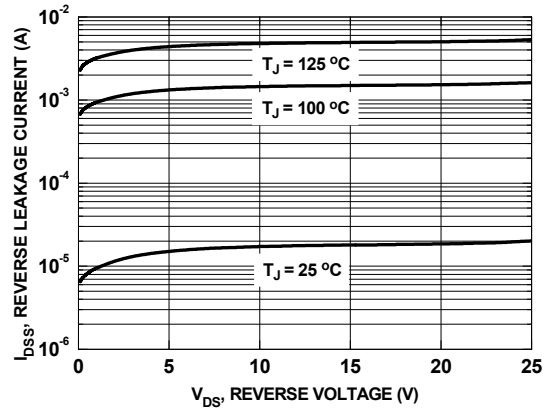
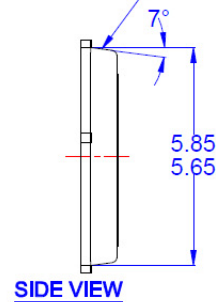
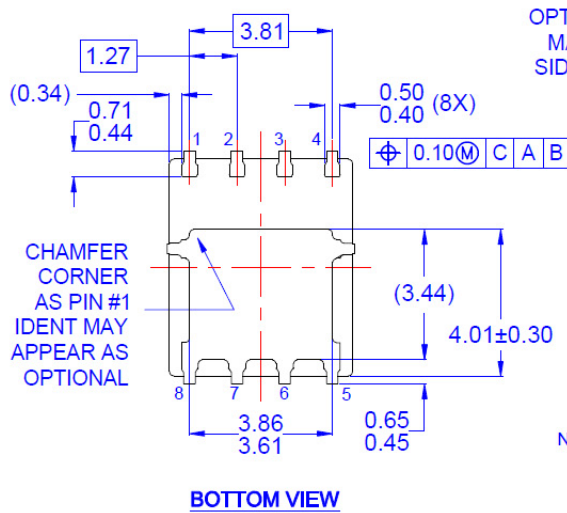
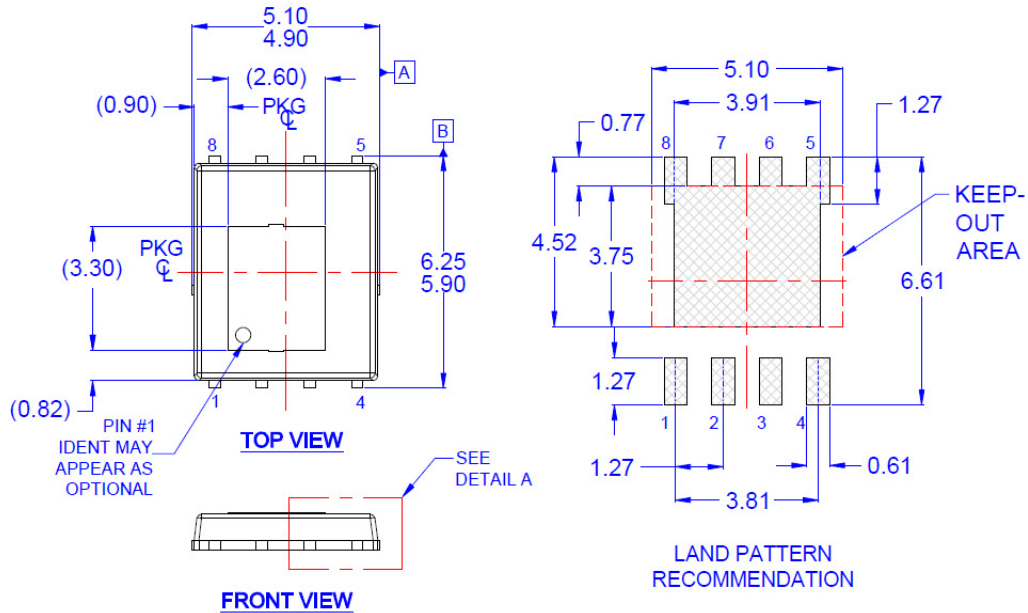
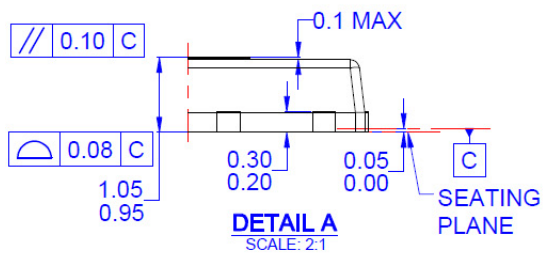

Figure 15. SyncFET body diode reverse leakage versus drain-source voltage

Dimensional Outline and Pad Layout



- NOTES: UNLESS OTHERWISE SPECIFIED
- A) PACKAGE STANDARD REFERENCE: JEDEC MO-240, ISSUE A, VAR. AA, DATED OCTOBER 2002.
 - B) ALL DIMENSIONS ARE IN MILLIMETERS.
 - C) DIMENSIONS DO NOT INCLUDE BURRS OR MOLD FLASH. MOLD FLASH OR BURRS DOES NOT EXCEED 0.10MM.
 - D) DIMENSIONING AND TOLERANCING PER ASME Y14.5M-1994.
 - E) IT IS RECOMMENDED TO HAVE NO TRACES OR VIAS WITHIN THE KEEP OUT AREA.





TRADEMARKS

The following includes registered and unregistered trademarks and service marks, owned by Fairchild Semiconductor and/or its global subsidiaries, and is not intended to be an exhaustive list of all such trademarks.

- | | | | |
|--------------------------|---|---|------------------|
| 2Cool™ | FPS™ | PowerTrench® | Sync-Lock™* |
| AccuPower™ | F-PFET™ | PowerXS™ | SYSTEM GENERAL®* |
| AX-CAP®* | FRFET® | Programmable Active Droop™ | TinyBoost™ |
| BISiC™ | Global Power Resource™ | QFET® | TinyBuck™ |
| Build it Now™ | Green Bridge™ | QS™ | TinyCalc™ |
| CorePLUS™ | Green FPS™ | Quiet Series™ | TinyLogic™ |
| CorePOWER™ | Green FPS™ e-Series™ | RapidConfigure™ | TINYOPTO™ |
| CROSSVOLT™ | Gmax™ | IntelliMAX™ | TinyPower™ |
| CTL™ | GTO™ | ISOPLANAR™ | TinyPWM™ |
| Current Transfer Logic™ | IntelliMAX™ | Marking Small Speakers Sound Louder and Better™ | TinyWire™ |
| DEUXPEED® | ISOPLANAR™ | MegaBuck™ | TranSiC® |
| Dual Cool™ | Marking Small Speakers Sound Louder and Better™ | MICROCOUPLER™ | TriFault Detect™ |
| EcoSPARK® | MegaBuck™ | MicroFET™ | TRUECURRENT®* |
| EfficientMax™ | MICROCOUPLER™ | MicroPak™ | µSerDes™ |
| ESBC™ | MicroFET™ | MicroPak2™ | SarDes™ |
| Fairchild® | MicroPak™ | MillerDrive™ | UHC® |
| Fairchild Semiconductor® | MicroPak2™ | MotionMax™ | Ultra FRFET™ |
| FACT Quiet Series™ | MillerDrive™ | mWSaver™ | UniFET™ |
| FACT® | MotionMax™ | OptoHiT™ | VCX™ |
| FAST® | mWSaver™ | OPTOLOGIC® | VisualMax™ |
| FastvCore™ | OptoHiT™ | OPTOPLANAR® | VoltagePlus™ |
| FETBench™ | OPTOLOGIC® | | XS™ |
| | OPTOPLANAR® | | |

*Trademarks of System General Corporation, used under license by Fairchild Semiconductor.

DISCLAIMER

FAIRCHILD SEMICONDUCTOR RESERVES THE RIGHT TO MAKE CHANGES WITHOUT FURTHER NOTICE TO ANY PRODUCTS HEREIN TO IMPROVE RELIABILITY, FUNCTION, OR DESIGN. FAIRCHILD DOES NOT ASSUME ANY LIABILITY ARISING OUT OF THE APPLICATION OR USE OF ANY PRODUCT OR CIRCUIT DESCRIBED HEREIN; NEITHER DOES IT CONVEY ANY LICENSE UNDER ITS PATENT RIGHTS, NOR THE RIGHTS OF OTHERS. THESE SPECIFICATIONS DO NOT EXPAND THE TERMS OF FAIRCHILD'S WORLDWIDE TERMS AND CONDITIONS, SPECIFICALLY THE WARRANTY THEREIN, WHICH COVERS THESE PRODUCTS.

LIFE SUPPORT POLICY

FAIRCHILD'S PRODUCTS ARE NOT AUTHORIZED FOR USE AS CRITICAL COMPONENTS IN LIFE SUPPORT DEVICES OR SYSTEMS WITHOUT THE EXPRESS WRITTEN APPROVAL OF FAIRCHILD SEMICONDUCTOR CORPORATION.

As used here in:

- Life support devices or systems are devices or systems which, (a) are intended for surgical implant into the body or (b) support or sustain life, and (c) whose failure to perform when properly used in accordance with instructions for use provided in the labeling, can be reasonably expected to result in a significant injury of the user.
- A critical component in any component of a life support, device, or system whose failure to perform can be reasonably expected to cause the failure of the life support device or system, or to affect its safety or effectiveness.

ANTI-COUNTERFEITING POLICY

Fairchild Semiconductor Corporation's Anti-Counterfeiting Policy. Fairchild's Anti-Counterfeiting Policy is also stated on our external website, www.fairchildsemi.com, under Sales Support.

Counterfeiting of semiconductor parts is a growing problem in the industry. All manufactures of semiconductor products are experiencing counterfeiting of their parts. Customers who inadvertently purchase counterfeit parts experience many problems such as loss of brand reputation, substandard performance, failed application, and increased cost of production and manufacturing delays. Fairchild is taking strong measures to protect ourselves and our customers from the proliferation of counterfeit parts. Fairchild strongly encourages customers to purchase Fairchild parts either directly from Fairchild or from Authorized Fairchild Distributors who are listed by country on our web page cited above. Products customers buy either from Fairchild directly or from Authorized Fairchild Distributors are genuine parts, have full traceability, meet Fairchild's quality standards for handling and storage and provide access to Fairchild's full range of up-to-date technical and product information. Fairchild and our Authorized Distributors will stand behind all warranties and will appropriately address and warranty issues that may arise. Fairchild will not provide any warranty coverage or other assistance for parts bought from Unauthorized Sources. Fairchild is committed to combat this global problem and encourage our customers to do their part in stopping this practice by buying direct or from authorized distributors.

PRODUCT STATUS DEFINITIONS

Definition of Terms

| Datasheet Identification | Product Status | Definition |
|--------------------------|-----------------------|---|
| Advance Information | Formative / In Design | Datasheet contains the design specifications for product development. Specifications may change in any manner without notice. |
| Preliminary | First Production | Datasheet contains preliminary data; supplementary data will be published at a later date. Fairchild Semiconductor reserves the right to make changes at any time without notice to improve design. |
| No Identification Needed | Full Production | Datasheet contains final specifications. Fairchild Semiconductor reserves the right to make changes at any time without notice to improve the design. |
| Obsolete | Not In Production | Datasheet contains specifications on a product that is discontinued by Fairchild Semiconductor. The datasheet is for reference information only. |

Rev. I64