

# FDC6332L

## Common Source Load Switch

### P-Channel 1.8V Specified PowerTrench® MOSFET

#### General Description

This Load Switch integrates an N-Channel Power MOSFET that drives Common-Source P-Channels and in a small SuperSot™-6 package. It uses Fairchild's advanced low voltage PowerTrench process. The  $R_{DS(ON)}$  is 750 mΩ per the switch @  $V_{GS}$  1.8V and is optimized for battery power management applications.

#### Applications

- Battery management/Charger Application
- Accessory load switching

#### Features

- -1 A, 8 V.  $R_{DS(ON)} = 350 \text{ m}\Omega @ V_{GS} = -4.5 \text{ V}$   
 $R_{DS(ON)} = 500 \text{ m}\Omega @ V_{GS} = -2.5 \text{ V}$   
 $R_{DS(ON)} = 750 \text{ m}\Omega @ V_{GS} = -1.8 \text{ V}$
- N-Channel MOSFET includes Zener protection for ESD ruggedness (>6KV Human body model)
- High performance trench technology for extremely low  $R_{DS(ON)}$

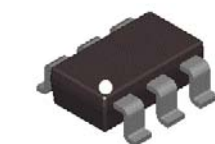

SuperSOT™-6

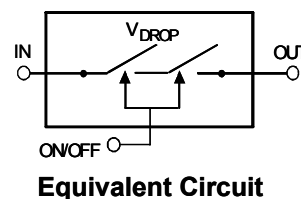
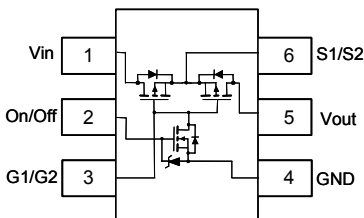

#### Absolute Maximum Ratings

$T_A=25^\circ\text{C}$  unless otherwise noted

Symbol	Parameter	Ratings	Units
$V_{IN}$	Input Voltage	$\pm 8$	V
$V_{ON}$	Turn-On Voltage	8	V
$I_{Load}$	Load Current – Continuous (Note 1)	-1.0	A
	– Pulsed	-2.0	
$P_D$	Maximum Power Dissipation (Note 1)	0.7	W
$T_J, T_{STG}$	Operating and Storage Junction Temperature Range	-55 to +150	$^\circ\text{C}$

#### Thermal Characteristics

$R_{\theta JA}$	Thermal Resistance, Junction-to-Ambient (Note 1)	160	$^\circ\text{C/W}$
$R_{\theta JC}$	Thermal Resistance, Junction-to-Case (Note 1)	90	

#### Package Marking and Ordering Information

	Device	Reel Size	Tape width	Quantity
.332	FDC6332L	7"	8mm	3000 units

## Electrical Characteristics

$T_A = 25^\circ\text{C}$  unless otherwise noted

Symbol	Parameter	Test Conditions	Min	Typ	Max	Units
$BV_{IN}$	Input – Output Breakdown Voltage	$V_{ON/OFF} = 0\text{ V}, I_D = -250\ \mu\text{A}$	-20			V
$IR_{IN}$	Reverse Input Current	$V_{IN} = -8\text{ V}, V_{ON/OFF} = 0\text{ V}$			-1	$\mu\text{A}$
$BVG_{OFF}$	Driver FET Gate Breakdown Voltage	$I_G = 250\ \mu\text{A}$	8			V
$I_{G_{OFF}}$	Driver FET Gate Leakage Current	$V_G = 8\text{ V}$			100	nA

### On Characteristics (Note 2)

$V_{IN}$	Input Voltage Range		1.8	2.5	8	V
$V_{ON}$	Turn-On Voltage Range		1.5		8	V
$V_{OFF}$	Turn-off Voltage Range		-0.2		0.2	V
$I_{LOAD}$	Output Load Current	$V_{IN} = -5\text{ V}, V_{ON} = -4.5\text{ V}$	-1			A
$R_{DS(on)}$	Static Drain–Source On–Resistance	$V_{GS} = 4.5\text{ V}, I_D = -1.0\text{ A}$ $V_{GS} = 2.5\text{ V}, I_D = -0.9\text{ A}$ $V_{GS} = 1.8\text{ V}, I_D = -0.7\text{ A}$		230 338 643	350 500 750	$\text{m}\Omega$
$R_{ON}$	Loadswitch On-Resistance	$V_{IN} = 8\text{ V}, I_D = -1.0\text{ A}$ $V_{IN} = 8\text{ V}, I_D = -0.9\text{ A}$ $V_{IN} = 8\text{ V}, I_D = -0.7\text{ A}$		409 411 420		$\text{m}\Omega$

### Drain–Source Diode Characteristics and Maximum Ratings

$I_S$	Maximum Continuous Drain–Source Diode Forward Current				-0.6	A
$V_{SD}$	Drain–Source Diode Forward Voltage	$V_{ON/OFF} = 0\text{ V}, I_S = -0.6\text{ A}$ (Note 2)		-0.9	-1.2	V

Notes:

- $R_{\theta JA}$  is the sum of the junction-to-case and case-to-ambient thermal resistance where the case thermal reference is defined as the solder mounting surface of the drain pins.  $R_{\theta JC}$  is guaranteed by design while  $R_{\theta CA}$  is determined by the user's board design.

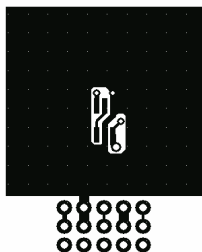

- a)  $90^\circ\text{C/W}$  when mounted on a  $1\text{ in}^2$  pad of 2 oz copper

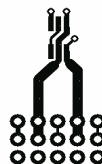

- b)  $160^\circ\text{C/W}$  when mounted on a minimum pad of 2 oz copper

Scale 1 : 1 on letter size paper

- Pulse Test: Pulse Width <  $300\ \mu\text{s}$ , Duty Cycle < 2.0%

### FDC6332L Load Switch Application Circuit

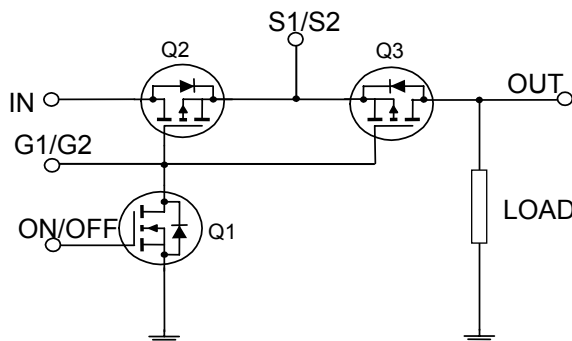

Typical Characteristics

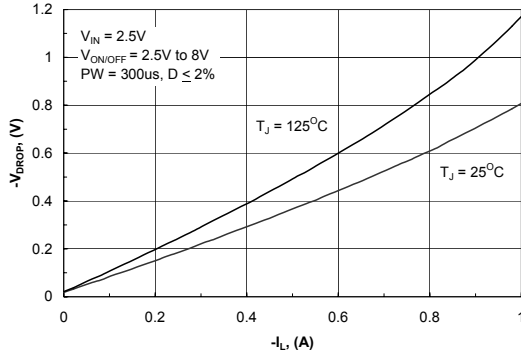

Figure 1. Conduction Voltage Drop Variation with Load Current.

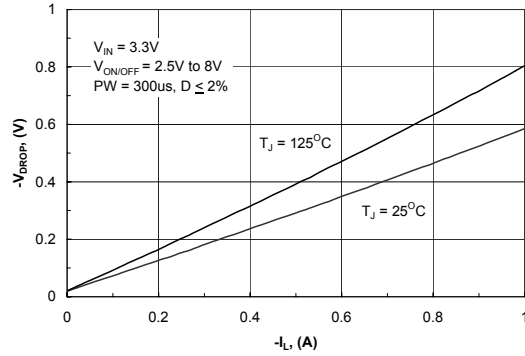

Figure 2. Conduction Voltage Drop Variation with Load Current.

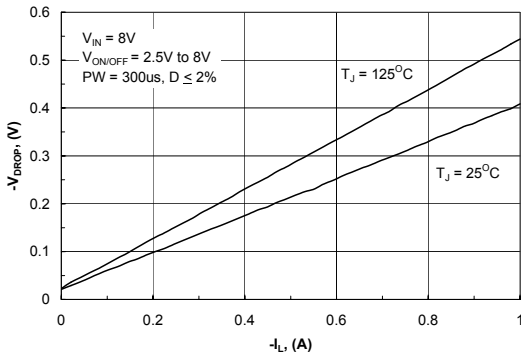

Figure 3. Conduction Voltage Drop Variation with Load Current.

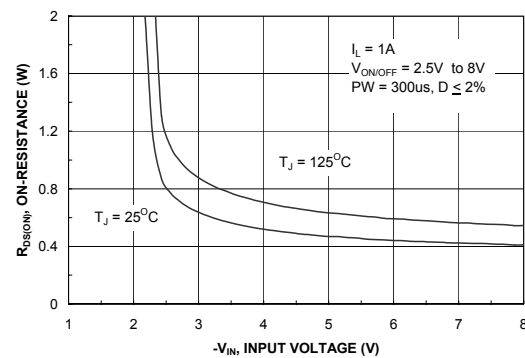

Figure 4. On-Resistance Variation With Input Voltage

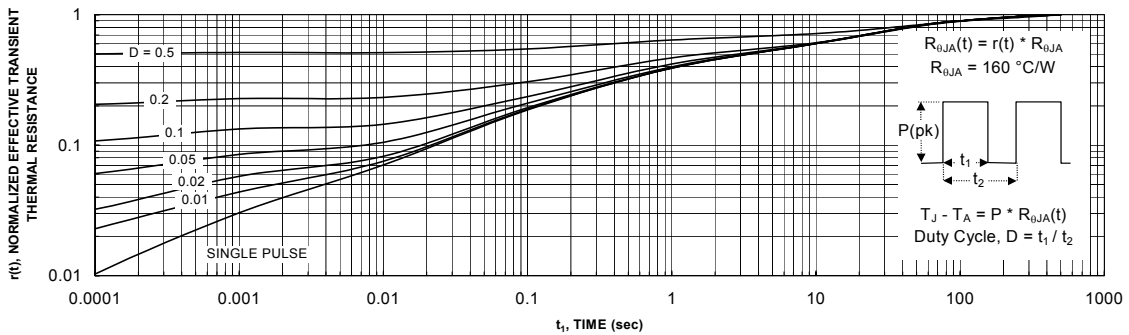

Figure 5. Transient Thermal Response Curve.

Thermal characterization performed using the conditions described in Note 1  
 Transient thermal response will change depending on the circuit board design.

## TRADEMARKS

The following are registered and unregistered trademarks Fairchild Semiconductor owns or is authorized to use and is not intended to be an exhaustive list of all such trademarks.

ACEx™	FACT™	ImpliedDisconnect™	PACMAN™	SPM™
ActiveArray™	FACT Quiet Series™	ISOPLANAR™	POP™	Stealth™
Bottomless™	FAST®	LittleFET™	Power247™	SuperSOT™-3
CoolFET™	FASTr™	MicroFET™	PowerTrench®	SuperSOT™-6
CROSSVOLT™	FRFET™	MicroPak™	QFET™	SuperSOT™-8
DOME™	GlobalOptoisolator™	MICROWIRE™	QS™	SyncFET™
EcoSPARK™	GTO™	MSX™	QT Optoelectronics™	TinyLogic®
E <sup>2</sup> CMOS™	HiSeC™	MSXPro™	Quiet Series™	TruTranslation™
EnSigna™	ꞆC™	OCX™	RapidConfigure™	UHC™
Across the board. Around the world.™		OCXPro™	RapidConnect™	UltraFET®
The Power Franchise™		OPTOLOGIC®	SILENT SWITCHER®	VCX™
Programmable Active Droop™		OPTOPLANAR™	SMART START™	

## DISCLAIMER

FAIRCHILD SEMICONDUCTOR RESERVES THE RIGHT TO MAKE CHANGES WITHOUT FURTHER NOTICE TO ANY PRODUCTS HEREIN TO IMPROVE RELIABILITY, FUNCTION OR DESIGN. FAIRCHILD DOES NOT ASSUME ANY LIABILITY ARISING OUT OF THE APPLICATION OR USE OF ANY PRODUCT OR CIRCUIT DESCRIBED HEREIN; NEITHER DOES IT CONVEY ANY LICENSE UNDER ITS PATENT RIGHTS, NOR THE RIGHTS OF OTHERS.

## LIFE SUPPORT POLICY

FAIRCHILD'S PRODUCTS ARE NOT AUTHORIZED FOR USE AS CRITICAL COMPONENTS IN LIFE SUPPORT DEVICES OR SYSTEMS WITHOUT THE EXPRESS WRITTEN APPROVAL OF FAIRCHILD SEMICONDUCTOR CORPORATION.

As used herein:

1. Life support devices or systems are devices or systems which, (a) are intended for surgical implant into the body, or (b) support or sustain life, or (c) whose failure to perform when properly used in accordance with instructions for use provided in the labeling, can be reasonably expected to result in significant injury to the user.
2. A critical component is any component of a life support device or system whose failure to perform can be reasonably expected to cause the failure of the life support device or system, or to affect its safety or effectiveness.

## PRODUCT STATUS DEFINITIONS

### Definition of Terms

Datasheet Identification	Product Status	Definition
Advance Information	Formative or In Design	This datasheet contains the design specifications for product development. Specifications may change in any manner without notice.
Preliminary	First Production	This datasheet contains preliminary data, and supplementary data will be published at a later date. Fairchild Semiconductor reserves the right to make changes at any time without notice in order to improve design.
No Identification Needed	Full Production	This datasheet contains final specifications. Fairchild Semiconductor reserves the right to make changes at any time without notice in order to improve design.
Obsolete	Not In Production	This datasheet contains specifications on a product that has been discontinued by Fairchild semiconductor. The datasheet is printed for reference information only.