

# FAN7083\_F085

## High Side Gate Driver with Reset

### Features

- Qualified to AEC Q100
- Floating channel designed for bootstrap operation up fully operational to + 600V
- Tolerance to negative transient voltage on VS pin
- dv/dt immune.
- Gate drive supply range from 10V to 20V
- Under-voltage lockout
- CMOS Schmitt-triggered inputs with pull-down
- High side output in phase with input
- RESET input is 3.3V and 5V logic compatible

### Typical Applications

- Diesel and gasolin injectors/vavles
- MOSFET-and IGBT high side driver applications

### Description

The FAN7083\_F085 is a high-side gate drive IC with reset input. It is designed for high voltage and high speed driving of MOSFET or IGBT, which operates up to 600V. Fairchild's high-voltage process and common-mode noise cancellation technique provide stable operation in the high side driver under high-dV/dt noise circumstances. An advanced level-shift circuit allows high-side gate driver operation up to VS=-5V (typical) at VBS=15V. Logic input is compatible with standard CMOS outputs. The UVLO circuits prevent from malfunction when VCC and VBS are lower than the specified threshold voltage. It is available with space saving SOIC-8 Package. Minimum source and sink current capability of output driver is 200mA and 400mA respectively, which is suitable for magetic-and piezo type injectors and general MOSFET/IGBT based high side driver applications.

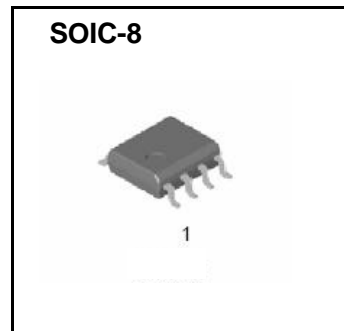

### Ordering Information

Device	Package	Operating Temp.
FAN7083CM	SOIC-8	-40 °C ~ 125 °C
FAN7083CMX	SOIC-8	-40 °C ~ 125 °C

X : Tape & Reel type

**Block Diagrams**

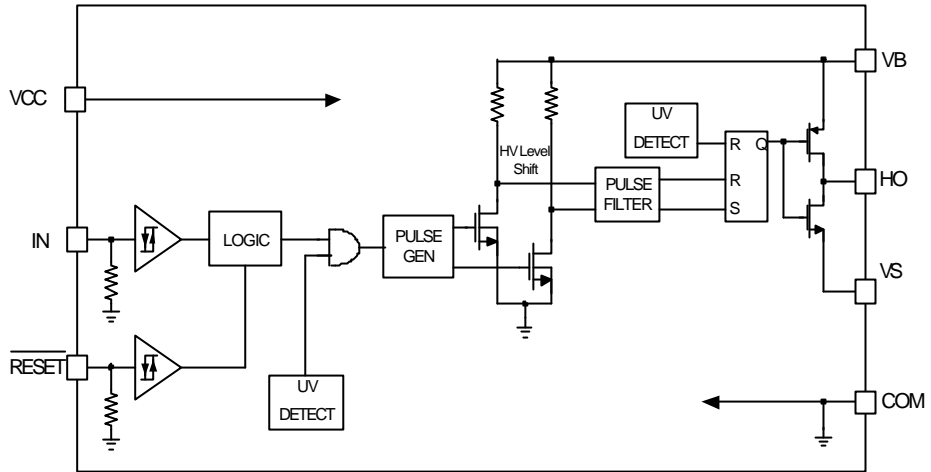

**Pin Assignments**

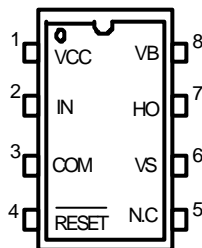

**Pin Definitions**

Pin Number	Pin Name	I/O	Pin Function Description
1	VCC	P	Driver supply voltage
2	IN	I	Logic input for high side gate drive output, in phase with HO
3	COM	P	Ground
4	RESET	I	Reset input
5	NC	-	NC
6	VS	P	High side floating offset for MOSFET Source connection
7	HO	A	High side drive output for MOSFET Gate connection
8	VB	P	Driver output stage supply

## Absolute Maximum Ratings

Absolute Maximum Ratings indicate sustained limits beyond which damage to the device may occur. All voltage parameters are absolute voltages referenced to COM.

Parameter	Symbol	Min.	Max.	Unit
High side floating supply offset voltage	VS	VB-25	VB+0.3	V
High side floating supply voltage	VB	-0.3	625	V
High side floating output voltage	VHO	Vs-0.3	VB+0.3	V
Supply voltage	VCC	-0.3	25	V
Input voltage for IN	VIN	-0.3	Vcc+0.3	V
Input voltage for RESET	VRESET	-0.3	Vcc+0.3	V
Power Dissipation <sup>1)</sup>	Pd		0.625	W
Thermal resistance, junction to ambient <sup>1)</sup>	Rthja		200	°C/W
Electrostatic discharge voltage (Human Body Model)	VESD	1K		V
Charge device model	VCDM	500		V
Junction Temperature	Tj		150	°C
Storage Temperature	Ts	-55	150	°C

Note: 1) The thermal resistance and power dissipation rating are measured bellow conditions;

JESD51-2: Integrated Circuit Thermal Test Method Environmental Conditions - Natural convection(StillAir)

JESD51-3 : Low Effective Thermal Conductivity Test Board for Leaded Surface Mount Package

## Recommended Operating Conditions

For proper operation the device should be used within the recommended conditions. -40°C ≤ Ta ≤ 125 °C

Parameter	Symbol	Min.	Max.	Unit
High side floating supply voltage -10V Transient 0.2us	VB	Vs + 10	Vs + 20	V
High side floating supply offset voltage(DC)	VS	-5	600	V
High side floating supply offset voltage(Transient)	VS	-25 (~200ns) -20(200ns~240ns) -7(240ns~400ns)	600	V
High side floating output voltage	VHO	Vs	VB	V
Allowable offset voltage Slew Rate <sup>1)</sup>	dv/dt	-	50	V/ns
Supply voltage	VCC	10	20	V
Input voltage for IN	VIN	0	Vcc	V
Input voltage for RESET	VRESET	0	Vcc	V
Switching Frequency <sup>2)</sup>	Fs		200	KHz
Ambient Temperature	Ta	-40	125	°C

Note : 1) Guaranteed by design.

2) Duty = 0.5

### Statics Electrical Characteristics

Unless otherwise specified,  $-40^{\circ}\text{C} \leq T_a \leq 125^{\circ}\text{C}$ ,  $V_{CC} = 15\text{V}$ ,  $V_{BS} = 15\text{V}$ ,  $V_{RESET} = 5\text{V}$ ,  $V_S = 0\text{V}$ ,  $R_L = 50\Omega$ ,  $C_L = 2.5\text{nF}$ .

Parameter	Symbol	Conditions	Min.	Typ.	Max.	Unit
<b>Vcc and VBS supply Characteristics</b>						
VCC and VBS supply under voltage positive going threshold	VCCUV+ VBSUV+	-	-	9.0	9.8	V
VCC and VBS supply under voltage negative going threshold	VCCUV- VBSUV-	-	7.4	8.4	-	V
VCC and VBS supply under voltage hysteresis	VCCUVH VBSUVH	-	0.2	0.6	-	V
Under voltage lockout response time	tduvcc tduvbs	VCC: 10V-->7.3V or 7.3V-->10V VBS: 10V-->7.3V or 7.3V-->10V	0.5 0.5		20 20	us us
Offset supply leakage current	ILK	$V_B = V_S = 600\text{V}$	-	-	50	uA
Quiescent VBS supply current	IQBS	$V_{IN} = 0$ , $V_{RESET} = 5\text{V}$	-	50	100	uA
Quiescent Vcc supply current	IQCC1	$V_{IN} = V_{RESET} = 0$	-	65	140	uA
Quiescent Vcc supply current	IQCC2	$V_{IN} = 15\text{V}$ , $V_{RESET} = 0$	-	75	160	uA
<b>Input Characteristics</b>						
High logic level input voltage for IN	V <sub>IH</sub>	-	0.6V <sub>cc</sub>		-	V
Low logic level input voltage for IN	V <sub>IL</sub>	-	-	-	0.4V <sub>cc</sub>	V
High logic level input current for IN	I <sub>IN+</sub>	$V_{IN} = 15\text{V}$	-	15	50	uA
Low logic level input bias current for IN	I <sub>IN-</sub>	$V_{IN} = 0$	-	0	1	uA
High logic level input voltage for $\overline{\text{RESET}}$	V <sub>RIH</sub>	-	3.0	-	-	V
Low logic level input voltage for $\overline{\text{RESET}}$	V <sub>RIL</sub>	-	-	-	1.4	V
High logic level input current for $\overline{\text{RESET}}$	I <sub>RIN+</sub>	$V_{RESET} = 5\text{V}$	-	5	30	uA
Low logic level input bias current for $\overline{\text{RESET}}$	I <sub>RIN-</sub>	$V_{RESET} = 0$	-	0	1	uA
<b>Output characteristics</b>						
High level output voltage, $V_{BIAS} - V_O$	V <sub>OH</sub>	$I_O = 0$	-	-	0.1	V
Low level output voltage, $V_O$	V <sub>OL</sub>	$I_O = 0$	-	-	0.1	V
Peak output source current	I <sub>O1+</sub>	-	200	-	-	mA
Peak output sink current	I <sub>O1-</sub>	-	400	-	-	mA
Equivalent output resistance	R <sub>OP</sub>			54	70	$\Omega$
	R <sub>ON</sub>			24	35	$\Omega$

Note: The input parameter are referenced to COM. The VO and IO parameters are referenced to COM.

### Dynamic Electrical Characteristics

Unless otherwise specified,  $-40^{\circ}\text{C} \leq T_a \leq 125^{\circ}\text{C}$ ,  $V_{CC} = 15\text{V}$ ,  $V_{BS} = 15\text{V}$ ,  $V_{RESET} = 5\text{V}$ ,  $V_S = 0\text{V}$ ,  $R_L = 50\Omega$ ,  $C_L = 2.5\text{nF}$ .

Parameter	Symbol	Conditions	Min.	Typ.	Max.	Unit
IN-to-output turn-on propagation delay	t <sub>plh</sub>	50% input level to 10% output level, V <sub>S</sub> = 0V	-	115	250	ns
IN-to-output turn-off propagation delay	t <sub>phl</sub>	50% input level to 90% output level V <sub>S</sub> = 0V	-	90	200	ns
RESET-to-output turn-off propagation delay	t <sub>phl_res</sub>	50% input level to 90% output level	-	90	200	ns
RESET-to-output turn-on propagation delay	t <sub>plh_res</sub>	50% input level to 10% output level	-	115	250	ns
Output rising time	t <sub>r1</sub>	T <sub>J</sub> =25°C, V <sub>BS</sub> =15V	-	200	400	ns
	t <sub>r2</sub>		-	-	500	ns
Output falling time	t <sub>f1</sub>	T <sub>J</sub> =25°C, V <sub>BS</sub> =15V	-	25	200	ns
	t <sub>f2</sub>		-	-	400	ns

## Application Information

### 1. Relationship in input/output and supplies

VCC	VBS	RESET	IN	HO
< VCCUVLO-	X	X	X	OFF
X	< VBSUVLO-	X	X	OFF
X	X	LOW	X	OFF
X	X	X	LOW	OFF
> VCCUVLO+	> VBSUVLO+	HIGH	HIGH	ON

Notes:

X means independent from signal

Typical Application Circuit

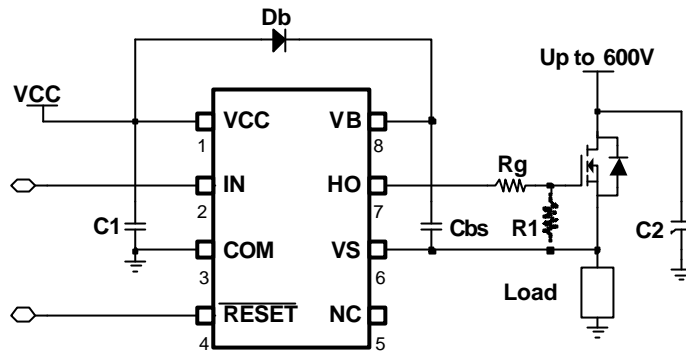

## Typical Waveforms

### 1. Input/Output Timing

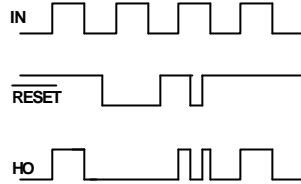

Figure 1a. Input/output Timing Diagram

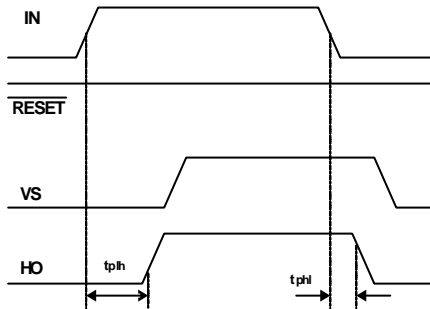

Figure 1b. Input(IN)/output Timing Diagram

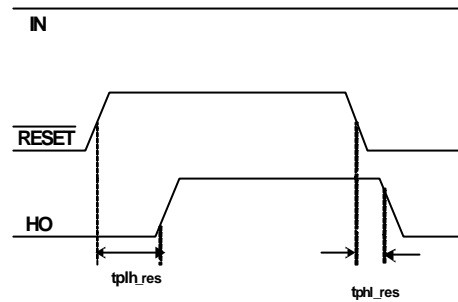

Figure 1c. Input(RESET)/output Timing Diagram

### 2. Output(HO) Switching Timing

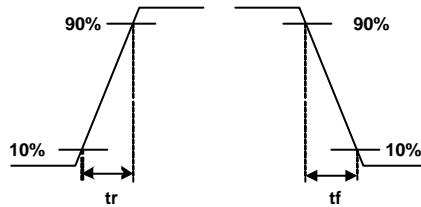

Figure 2. Switching Time Waveform Definitions



3.VB Drop Voltage Diagram

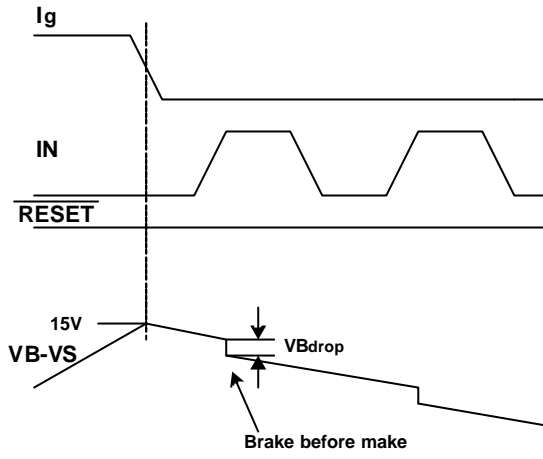

Figure 3a. VB Drop Voltage Diagram

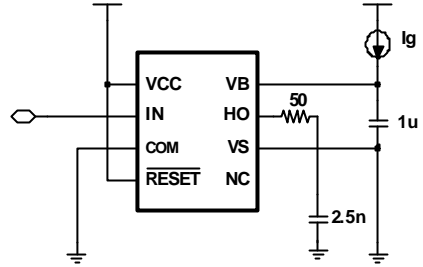

Figure3b. VB Drop Voltage Test Circuit

## Performance Graphs

This performance graphs based on ambient temperature  $-40^{\circ}\text{C}$   $-125^{\circ}\text{C}$

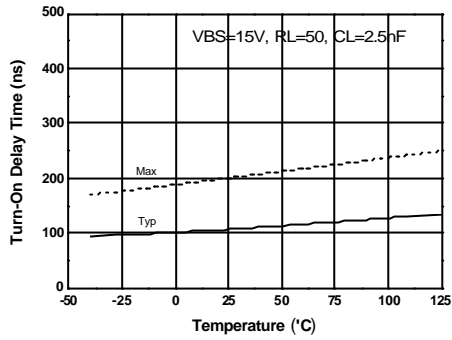

Figure 4a. Turn-On Delay Time vs Temperature

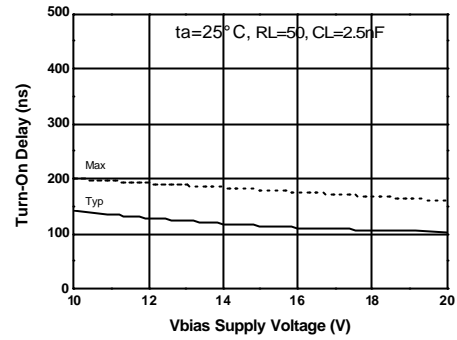

Figure 4b. Turn-On Delay Time vs VBS Supply Voltage

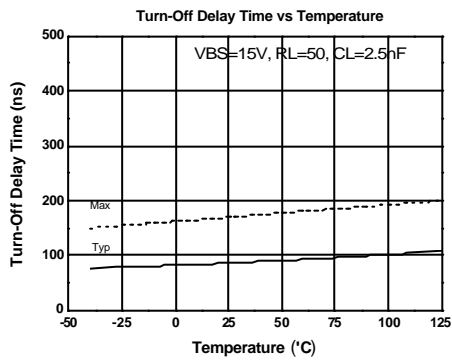

Figure 5a. Turn-Off Delay Time vs Temperature

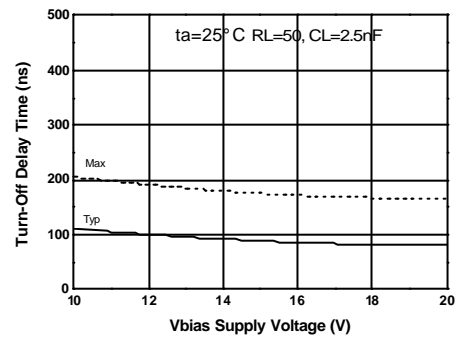

Figure 5b. Turn-Off Delay Time vs VBS Supply Voltage

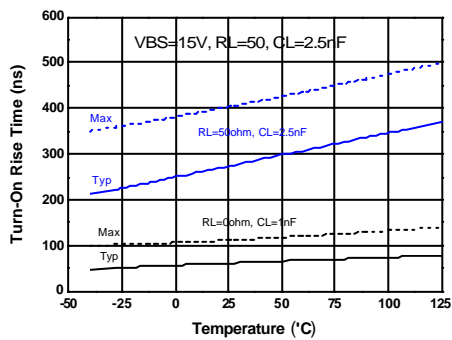

Figure 6a. Turn-On Rise Time vs Temperature

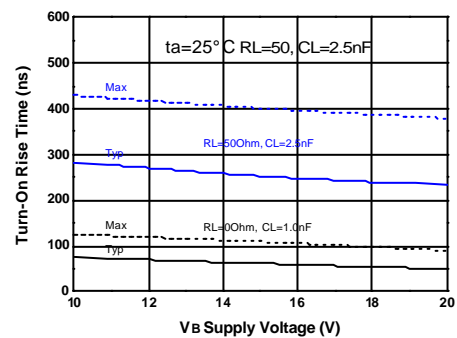

Figure 6b. Turn-On Rise Time vs VBS Supply Voltage

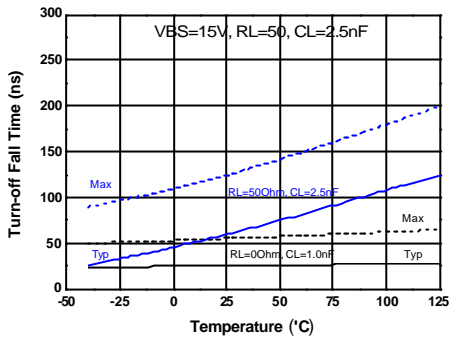

Figure 7a. Turn-Off Falling Time vs Temperature

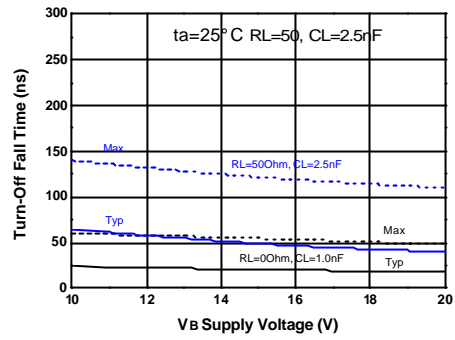

Figure 7b. Turn-Off Falling Time vs VBS Supply Voltage

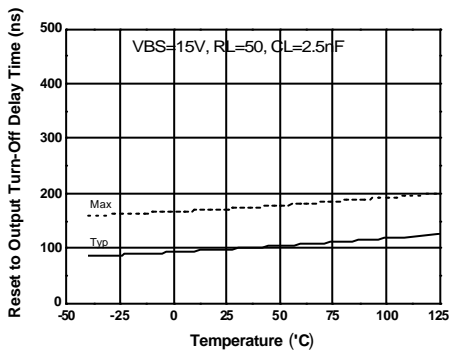

Figure 8a. RESET to output Turn-Off Delay Time vs Temperature

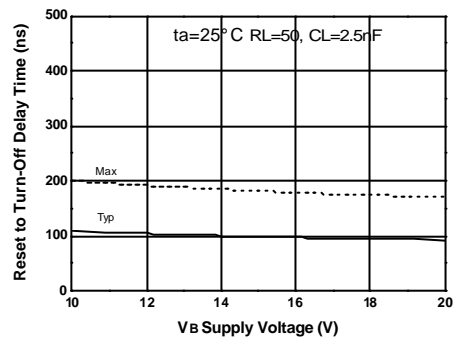

Figure 8b. RESET to output Turn-Off Delay Time vs VBS Supply

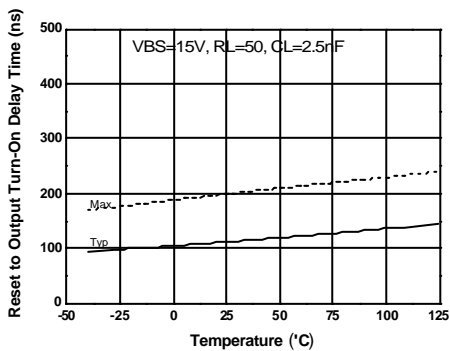

Figure 9a. RESET to output Turn-On Delay Time vs Temperature

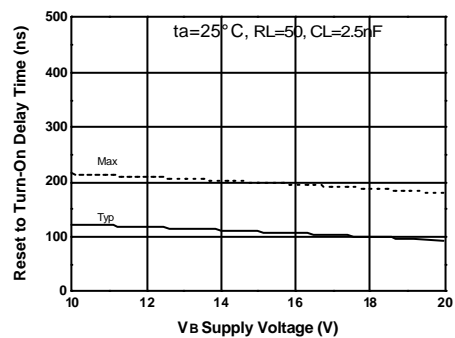

Figure 9b. RESET to output Turn-On Delay Time vs VBS Supply

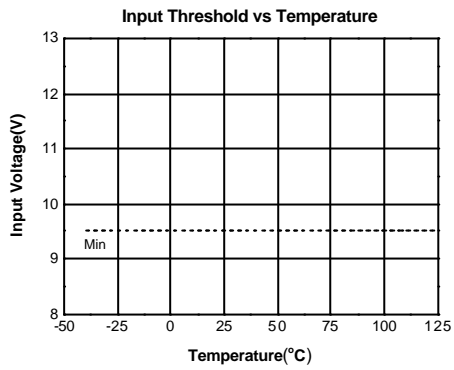

Figure 10a. Logic "1" IN Threshold vs Temperature

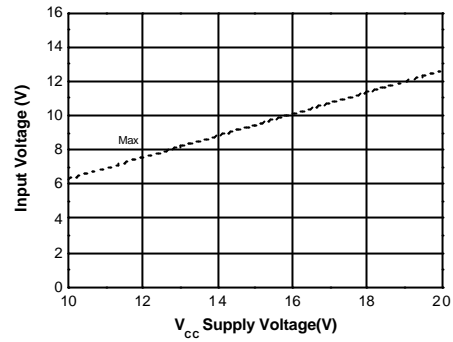

Figure 10b. Logic "1" IN Threshold vs VCC Supply Voltage

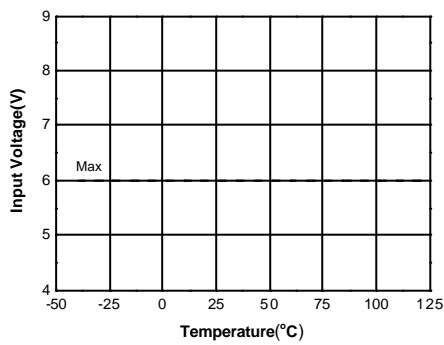

Figure 11a. Logic "0" IN Threshold vs Temperature

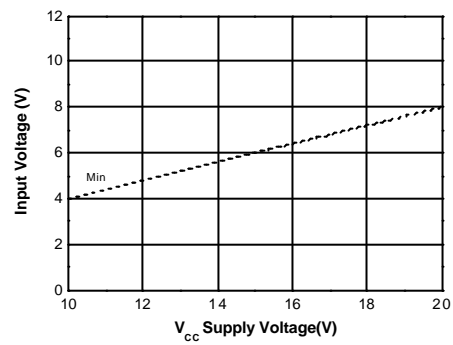

Figure 11b. Logic "0" IN Threshold vs VCC Supply Voltage

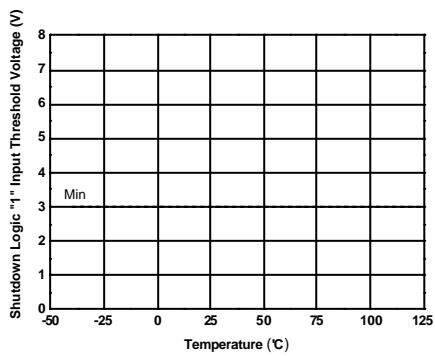

Figure 12a. Logic "1" Reset Threshold vs Temperature

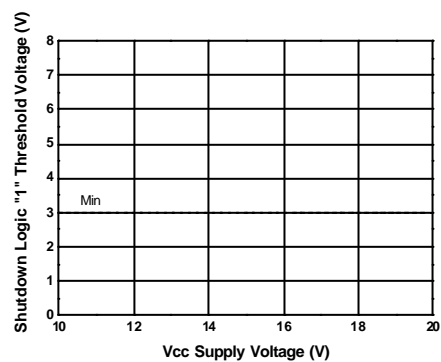

Figure 12b. Logic "1" Reset Threshold vs VCC Supply Voltage

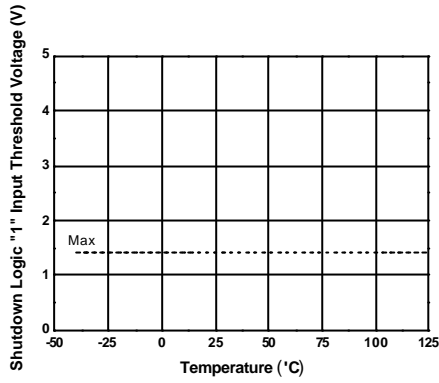

Figure 13a. Logic "0" Reset Threshold vs Temperature

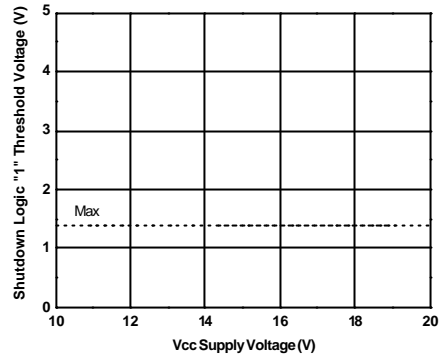

Figure 13b. Logic "0" Reset Threshold vs VCC Supply Voltage

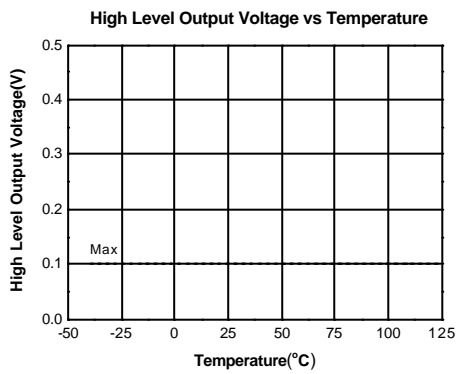

Figure 14a. High Level Output vs Temperature

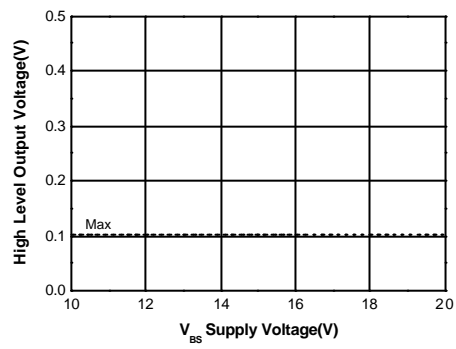

Figure 14b. High Level Output vs VBS Supply Voltage

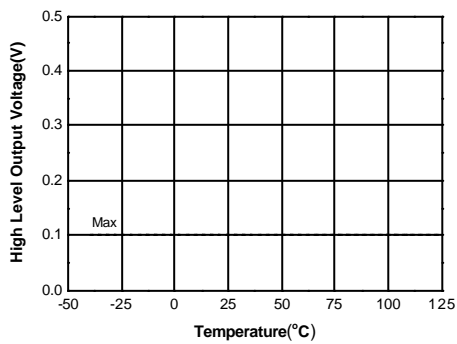

Figure 15a. Low Level Output vs Temperature

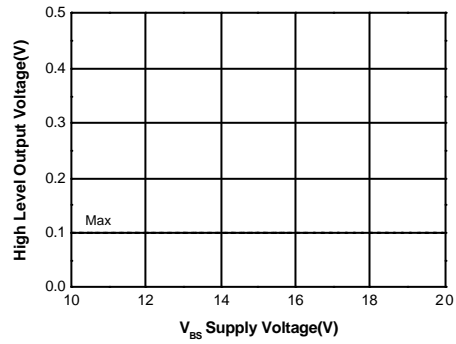

Figure 15b. Low Level Output vs VBS Supply Voltage

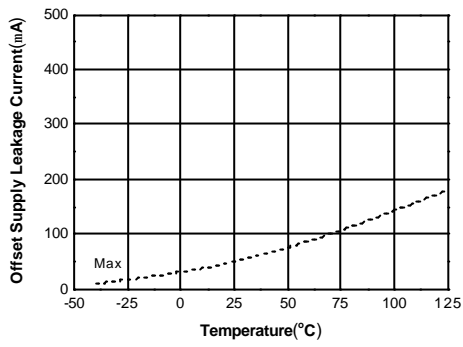

Figure 16a. Offset Supply Leakage vs Temperature

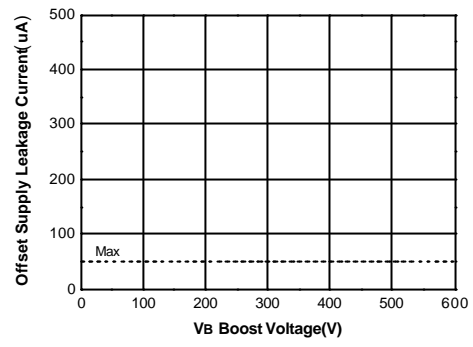

Figure 16b. Offset Supply Leakage vs Voltage

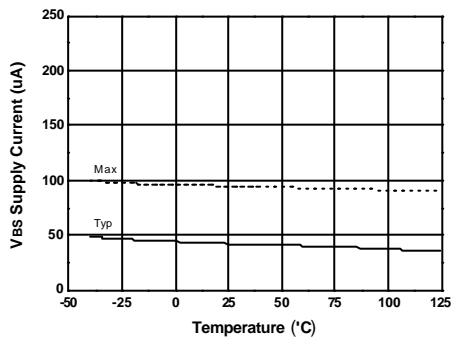

Figure 17a. VBS Supply Current vs Temperature

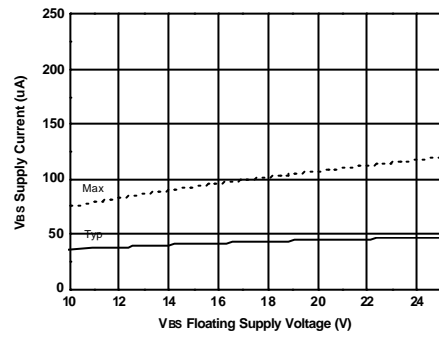

Figure 17b. VBS Supply Current vs VBS Supply Voltage

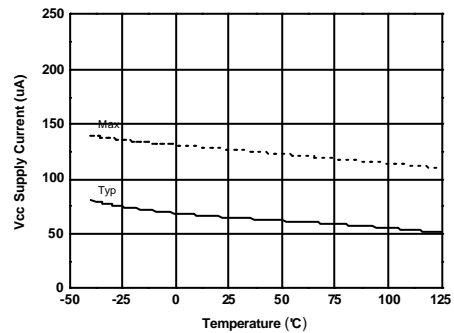

Figure 18a. VCC supply Current vs Temperature

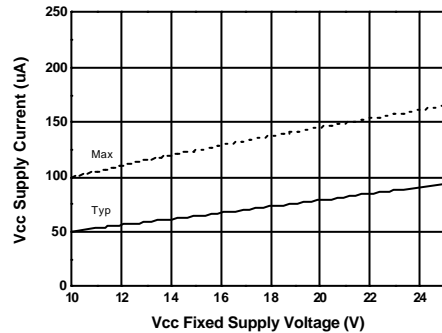

Figure 18b. VCC supply Current vs VCC Supply Voltage

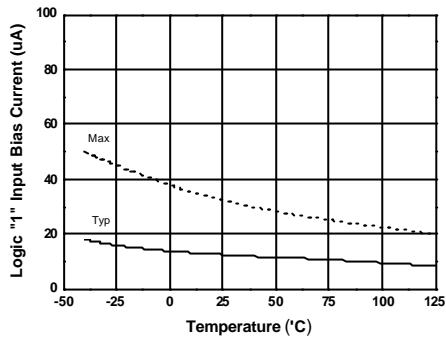

Figure 19a. Logic "1" IN Current vs Temperature

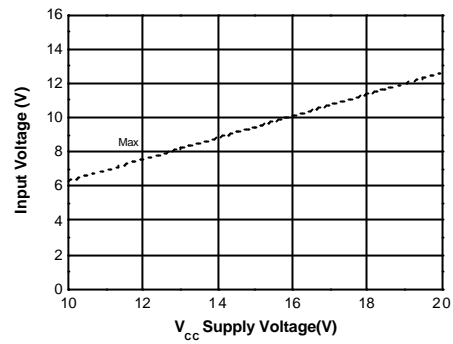

Figure 19b. Logic "1" IN Current vs Voltage

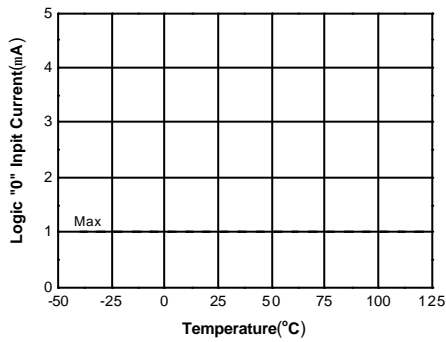

Figure 20a. Logic "0" IN Current vs Temperature

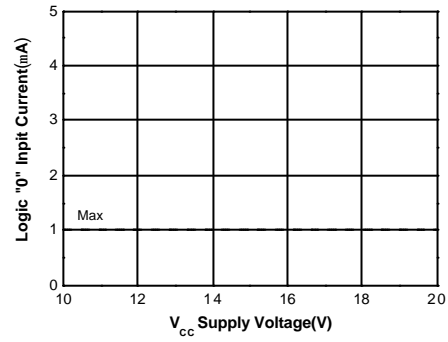

Figure 20b. Logic "0" IN Current vs Voltage

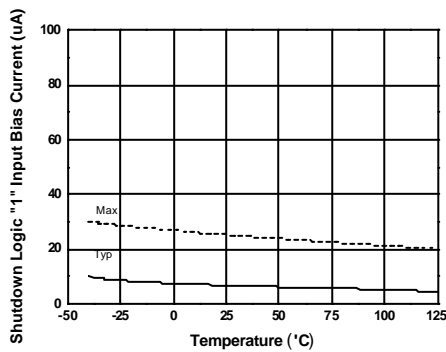

Figure 21. Logic "1" Reset Current vs Temperature

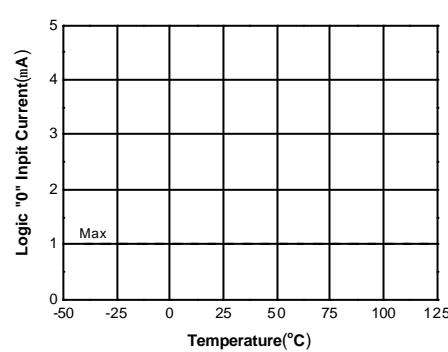

Figure 22. Logic "1" Reset Current vs Temperature

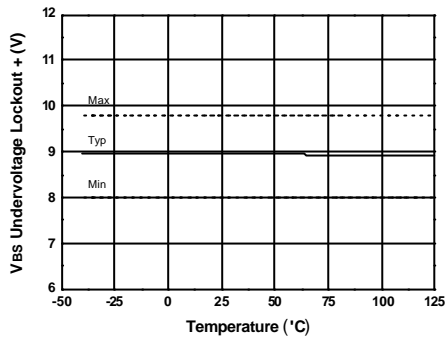

Figure 23a. VBS Undervoltage(+) vs Temperature

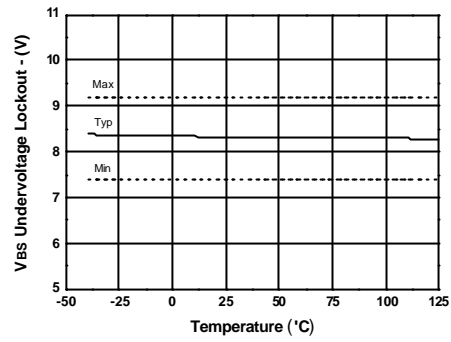

Figure 23b. VBS Undervoltage(-) vs Temperature

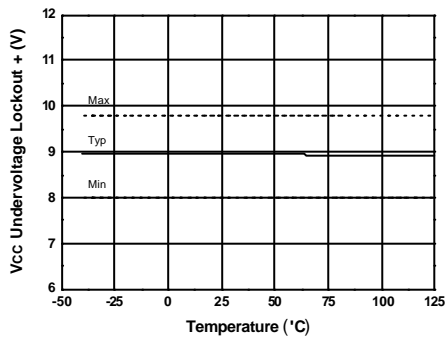

Figure 24a. VCC Undervoltage(+) vs Temperature

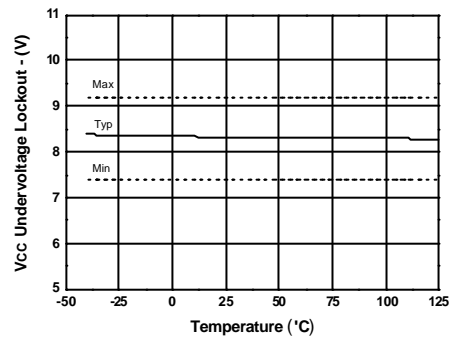

Figure 24b. VCC Undervoltage(-) vs Temperature

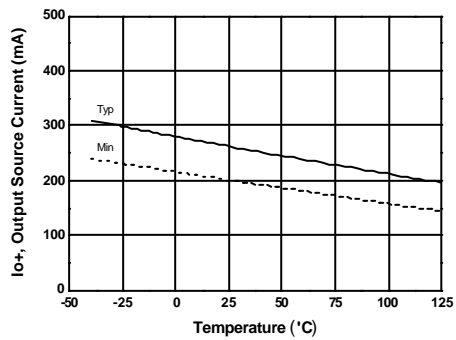

Figure 25a. Output Source Current vs Temperature

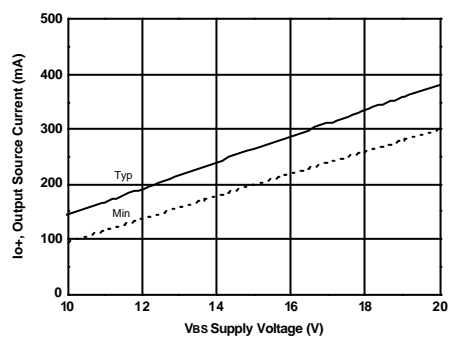

Figure 25b. Output Source Current vs Voltage



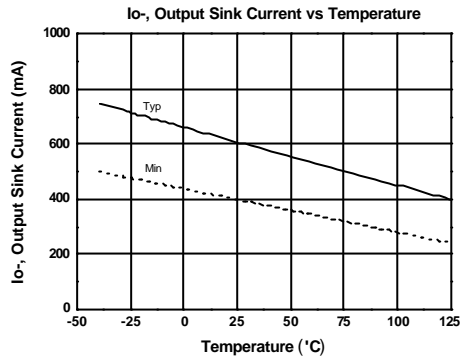

Figure 26a. Output Sink Current vs Temperature

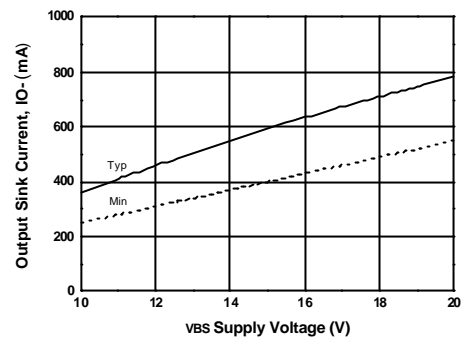

Figure 26b. Output Sink Current vs Voltage

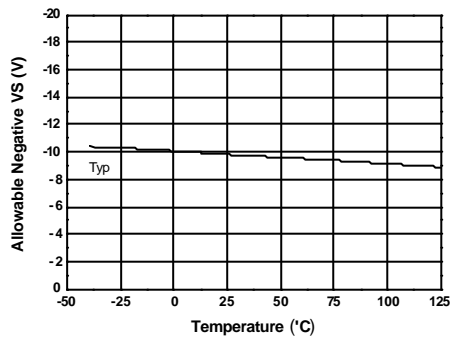

Figure 27a. Negative Allowable Offset vs Temperature

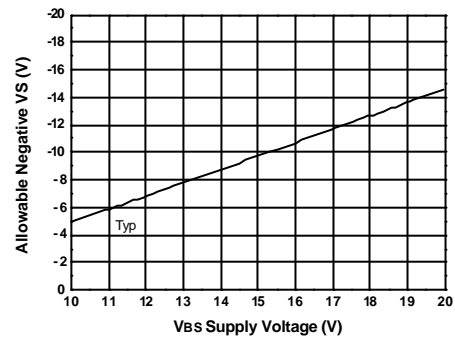
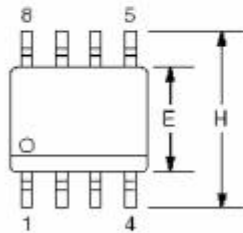

Figure 27b. Negative Allowable Offset vs Voltage

## Package Dimensions

### 8-SOP

Symbol	Inches		Millimeters		Notes
	Min.	Max.	Min.	Max.	
A	.053	.069	1.35	1.75	
A1	.004	.010	0.10	0.25	
B	.013	.020	0.33	0.51	
C	.0075	.010	0.20	0.25	5
D	.189	.197	4.80	5.00	2
E	.150	.158	3.81	4.01	2
e	.050 BSC		1.27 BSC		
H	.228	.244	5.79	6.20	
h	.010	.020	0.25	0.50	
L	.016	.050	0.40	1.27	3
N	8		8		6
$\alpha$	0°	8°	0°	8°	
ccc	—	.004	—	0.10	



**Notes:**

1. Dimensioning and tolerancing per ANSI Y14.5M-1982.
2. "D" and "E" do not include mold flash. Mold flash or protrusions shall not exceed .010 inch (0.25mm).
3. "L" is the length of terminal for soldering to a substrate.
4. Terminal numbers are shown for reference only.
5. "C" dimension does not include solder finish thickness.
6. Symbol "N" is the maximum number of terminals.

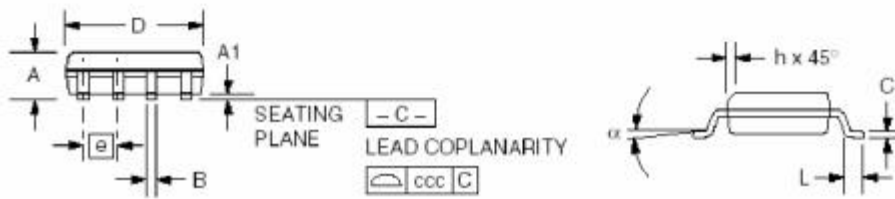



**TRADEMARKS**

The following includes registered and unregistered trademarks and service marks, owned by Fairchild Semiconductor and/or its global subsidiaries, and is not intended to be an exhaustive list of all such trademarks.

- |  |   |  |   |
|--|---|--|---|
| Build it Now™  | FRFET®  | Programmable Active Droop™   | the power franchise   |
| CorePLUS™  | Global Power Resource <sup>SM</sup>   | QFET®  | TinyBoost™  |
| CorePOWER™   | Green FPS™  | QS™  | TinyBuck™   |
| CROSSVOLT™   | Green FPS™ e-Series™  | Quiet Series™  | TinyLogic®  |
| CTL™   | GTO™  | RapidConfigure™  | TINYOPTO™   |
| Current Transfer Logic™  | IntelliMAX™   |  ™  | TinyPower™  |
| EcoSPARK®  | ISOPLANAR™  | Saving our world, 1mW/W/kW at a time™  | TinyPWM™  |
| EfficientMax™  | MegaBuck™   | SmartMax™  | TinyWire™   |
| EZSWITCH™*   | MICROCOUPLER™   | SMART START™   | TriFault Detect™  |
|  ™* | MicroFET™   | SPM®   | TRUECURRENT™*   |
|  ®  | MicroPak™   | STEALTH™   | µSerDes™  |
| Fairchild®   | MillerDrive™  | SuperFET™  |  ™ |
| Fairchild Semiconductor®   | MotionMax™  | SuperSOT™-3  | UHC®  |
| FACT Quiet Series™   | Motion-SPM™   | SuperSOT™-6  | Ultra FRFET™  |
| FACT®  | OPTOLOGIC®  | SuperSOT™-8  | UniFET™   |
| FAST®  | OPTOPLANAR®   | SupreMOS™  | VCX™  |
| FastvCore™   |  ® | SyncFET™   | VisualMax™  |
| FlashWriter®*  | PDP SPM™  |  ®* | XS™   |
| FPS™   | Power-SPM™  | The Power Franchise®   |   |
| F-PFS™   | PowerTrench®  |  |   |
|  | PowerXS™  |  |   |

\* Trademarks of System General Corporation, used under license by Fairchild Semiconductor.

**DISCLAIMER**

FAIRCHILD SEMICONDUCTOR RESERVES THE RIGHT TO MAKE CHANGES WITHOUT FURTHER NOTICE TO ANY PRODUCTS HEREIN TO IMPROVE RELIABILITY, FUNCTION, OR DESIGN. FAIRCHILD DOES NOT ASSUME ANY LIABILITY ARISING OUT OF THE APPLICATION OR USE OF ANY PRODUCT OR CIRCUIT DESCRIBED HEREIN; NEITHER DOES IT CONVEY ANY LICENSE UNDER ITS PATENT RIGHTS, NOR THE RIGHTS OF OTHERS. THESE SPECIFICATIONS DO NOT EXPAND THE TERMS OF FAIRCHILD'S WORLDWIDE TERMS AND CONDITIONS, SPECIFICALLY THE WARRANTY THEREIN, WHICH COVERS THESE PRODUCTS.

**LIFE SUPPORT POLICY**

FAIRCHILD'S PRODUCTS ARE NOT AUTHORIZED FOR USE AS CRITICAL COMPONENTS IN LIFE SUPPORT DEVICES OR SYSTEMS WITHOUT THE EXPRESS WRITTEN APPROVAL OF FAIRCHILD SEMICONDUCTOR CORPORATION.

As used herein:

1. Life support devices or systems are devices or systems which, (a) are intended for surgical implant into the body or (b) support or sustain life, and (c) whose failure to perform when properly used in accordance with instructions for use provided in the labeling, can be reasonably expected to result in a significant injury of the user.
2. A critical component in any component of a life support, device, or system whose failure to perform can be reasonably expected to cause the failure of the life support device or system, or to affect its safety or effectiveness.

**ANTI-COUNTERFEITING POLICY**

Fairchild Semiconductor Corporation's Anti-Counterfeiting Policy. Fairchild's Anti-Counterfeiting Policy is also stated on our external website, [www.fairchildsemi.com](http://www.fairchildsemi.com), under Sales Support.

Counterfeiting of semiconductor parts is a growing problem in the industry. All manufacturers of semiconductor products are experiencing counterfeiting of their parts. Customers who inadvertently purchase counterfeit parts experience many problems such as loss of brand reputation, substandard performance, failed applications, and increased cost of production and manufacturing delays. Fairchild is taking strong measures to protect ourselves and our customers from the proliferation of counterfeit parts. Fairchild strongly encourages customers to purchase Fairchild parts either directly from Fairchild or from Authorized Fairchild Distributors who are listed by country on our web page cited above. Products customers buy either from Fairchild directly or from Authorized Fairchild Distributors are genuine parts, have full traceability, meet Fairchild's quality standards for handling and storage and provide access to Fairchild's full range of up-to-date technical and product information. Fairchild and our Authorized Distributors will stand behind all warranties and will appropriately address any warranty issues that may arise. Fairchild will not provide any warranty coverage or other assistance for parts bought from Unauthorized Sources. Fairchild is committed to combat this global problem and encourage our customers to do their part in stopping this practice by buying direct or from authorized distributors.

**PRODUCT STATUS DEFINITIONS**

**Definition of Terms**

Datasheet Identification	Product Status	Definition
Advance Information	Formative / In Design	Datasheet contains the design specifications for product development. Specifications may change in any manner without notice.
Preliminary	First Production	Datasheet contains preliminary data; supplementary data will be published at a later date. Fairchild Semiconductor reserves the right to make changes at any time without notice to improve design.
No Identification Needed	Full Production	Datasheet contains final specifications. Fairchild Semiconductor reserves the right to make changes at any time without notice to improve the design.
Obsolete	Not In Production	Datasheet contains specifications on a product that is discontinued by Fairchild Semiconductor. The datasheet is for reference information only.