

CNW11AV-1

CNW11AV-2

CNW11AV-3

DESCRIPTION

The CNW11AV series are high voltage optocouplers in a wide body dual-in-line package (DIP).

Each optocoupler consists of a GaAs infrared emitter optically coupled to a silicon npn phototransistor with the base connected.

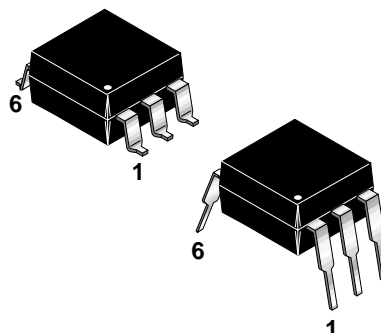

FEATURES

- Minimum 2 mm isolation thickness between emitter and receiver
- A wide body encapsulation with a pin distance of 10.16 mm
- An external clearance of 9.6 mm minimum and an external creepage of 10 mm minimum
- High current transfer ratio and low saturation voltage, making the device suitable for use with TTL integrated circuits
- High degree of AC and DC insulation (4000 V (RMS) and 5656 V (DC))
- Collector-emitter breakdown Voltage: 70 V
- Low isolation capacitance of 0.5 pF maximum
- UL recognized (File # E90700)
- VDE recognized (File # 76876)
- Ordering option '300' (e.g. CNW11AV-1.300)

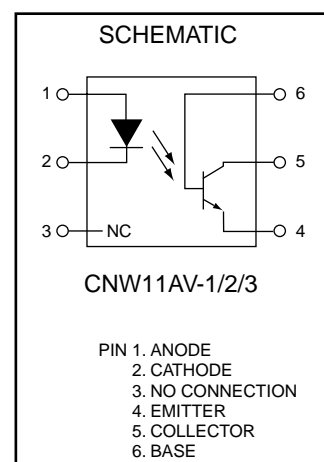

ABSOLUTE MAXIMUM RATINGS

Parameter	Symbol	Value	Units
TOTAL DEVICE			
Storage Temperature Range	T _{STG}	-55 to 150	°C
Ambient Operating Temperature Range	T _{OPR}	-40 to 100	°C
Lead Soldering Temperature	T _{SOL}	260 for 10 sec	°C
Junction Temperature	T _J	125	°C
EMITTER			
Forward Current - Continuous	I _F	100	mA
Forward Current - Peak (t _{on} = 10µs, δ = 0.01)	I _{F(pk)}	3	A
Reverse Voltage	V _R	6	V
Total Power Dissipation @ T _A = 25°C Derate Linearly From 25°C	P _D	200	mW
		2.0	mW/°C
DETECTOR			
Collector Current-Continuous	I _C	100	mA
Emitter-Collector Voltage	V _{ECO}	7	V
Collector-Emitter Voltage	V _{CEO}	70	V
Collector-Base Voltage	V _{CBO}	70	V
Total Power Dissipation @ T _A = 25°C Derate Linearly From 25°C	P _D	200	mW
		2.0	mW/°C

CNW11AV-1

CNW11AV-2

CNW11AV-3

ELECTRICAL CHARACTERISTICS ($T_A = 25^\circ\text{C}$ Unless otherwise specified)

Parameter	Test Conditions	Symbol	Min	Typ	Max	Unit
EMITTER Input Forward Voltage	$I_F = 10\text{ mA}$	V_F	0.8	1.15	1.50	V
	$I_F = 10\text{ mA}, T_A = -55^\circ\text{C}$		0.9	—	1.70	
	$I_F = 10\text{ mA}, T_A = 100^\circ\text{C}$		0.7	—	1.40	
Reverse Leakage Current	$V_R = 6.0\text{ V}$	I_R	—	—	10	μA
Input Capacitance	$V_I = 0, f = 1\text{ MHz}$	C_J	—	25	100	pF
DETECTOR						
Collector-Emitter Breakdown Voltage	$I_C = 1.0\text{ mA}$	BV_{CEO}	70	—	—	V
Collector-Base Breakdown Voltage	$I_C = 0.1\text{ mA}$	BV_{CBO}	70	—	—	V
Emitter-Collector Breakdown Voltage	$I_E = 0.1\text{ mA}$	BV_{ECO}	7	—	—	V
Emitter-Base Breakdown Voltage	$I_E = 0.1\text{ mA}$	BV_{EBO}	7	—	—	V
Collector-Emitter Dark Current	$V_{CE} = 10\text{ V}, I_F = 0, T_A = 25^\circ\text{C}$	I_{CEO}	—	0.5	50	nA
	$V_{CE} = 10\text{ V}, I_F = 0, T_A = 70^\circ\text{C}$		—	—	10	μA
Collector-Base Cut-off Current	$I_F = 0, V_{CB} = 10\text{ V}$	I_{CBO}	—	—	20	nA

ISOLATION CHARACTERISTICS

Characteristic	Test Conditions	Symbol	Min	Typ	Max	Units
Input-Output Isolation Voltage	DC Value, Time = 1 min.	V_{ISO}	5,656			V
	RMS Value, Time = 1 min.		4,000			
Isolation Resistance	$V_{I-O} = \pm 500\text{ VDC}$	R_{ISO}	1	10		$T\Omega$
Isolation Capacitance	$V = 0\text{ V}, f = 1\text{ MHz}$	C_{ISO}		0.3	0.5	pF
Output Capacitance	$V_{CB} = 10\text{ V}, f = 1\text{ MHz}$	C_O		4.5		pF

TRANSFER CHARACTERISTICS ($T_A = 25^\circ\text{C}$ Unless otherwise specified.)

DC Characteristics	Test Conditions	Symbol	Device	Min	Typ	Max	Units
Output/Input Current Transfer Ratio	$I_F = 10\text{ mA}, V_{CE} = 10\text{ V}$	CTR	CNW11AV-1	100		300	%
			CNW11AV-2	50			
			CNW11AV-3	20			
Collector-Emitter Saturation Voltage	$I_F = 20\text{ mA}, I_C = 2\text{ mA}$	$V_{CE(SAT)}$	All		0.1	0.4	V
Common Mode Rejection Ratio	$I_C = 2\text{ mA}, V_{CC} = 5\text{ V}, f = 10\text{ kHz}, R = 1\text{ k}\Omega$	CMRR	All		-60		dB
AC Characteristics	Test Conditions	Symbol	Device	Min	Typ	Max	Units
Saturated Switching Times							
Turn-On Time (fig. 2 & 3)	$I_C = 2\text{ mA}, V_{CC} = 10\text{ V}, R_L = 100\Omega$	t_{on}	All		3	15	μs
Turn-Off Time (fig. 2 & 3)		t_{off}	All		2.5	15	μs

CNW11AV-1

CNW11AV-2

CNW11AV-3

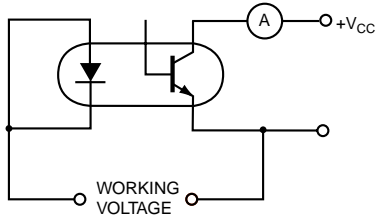

Fig. 1 Test Circuit

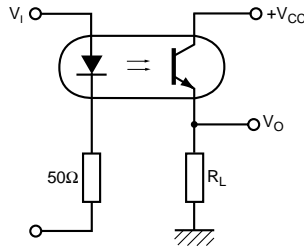

Fig. 2 Switching Circuit

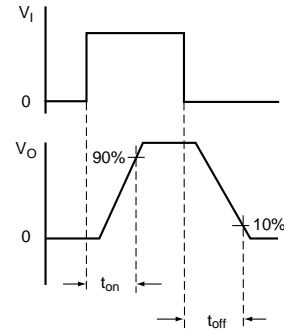

Fig. 3 Waveforms

Fig. 4 LED Forward Voltage vs. Forward Current

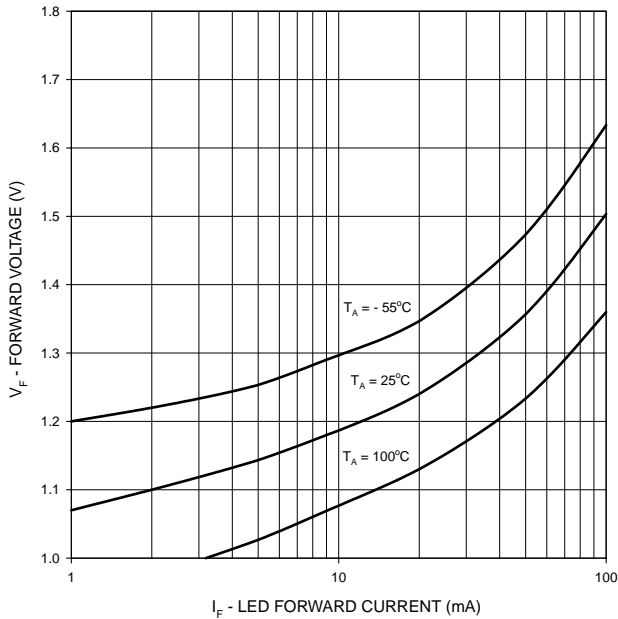

Fig. 5 Normalized CTR vs. Forward Current

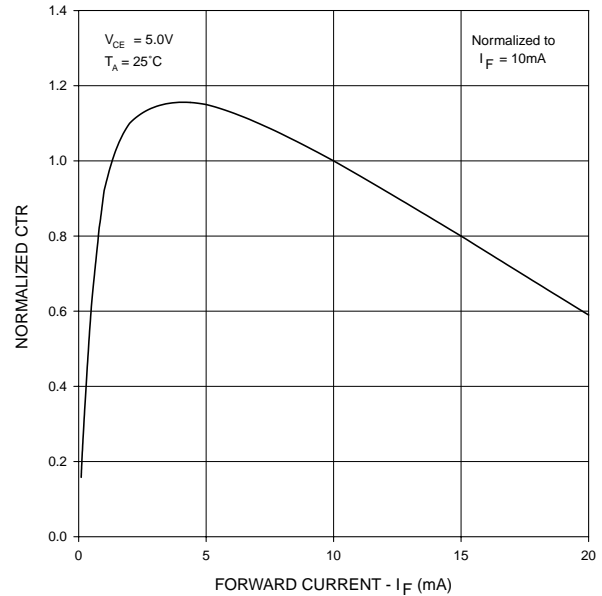

Fig. 6 Normalized CTR vs. Temperature

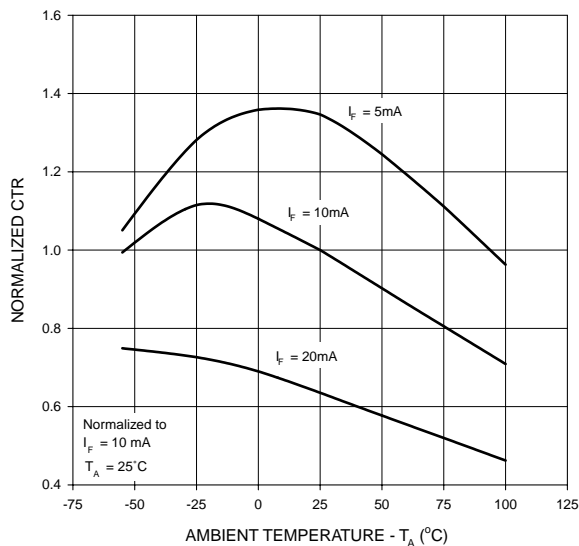
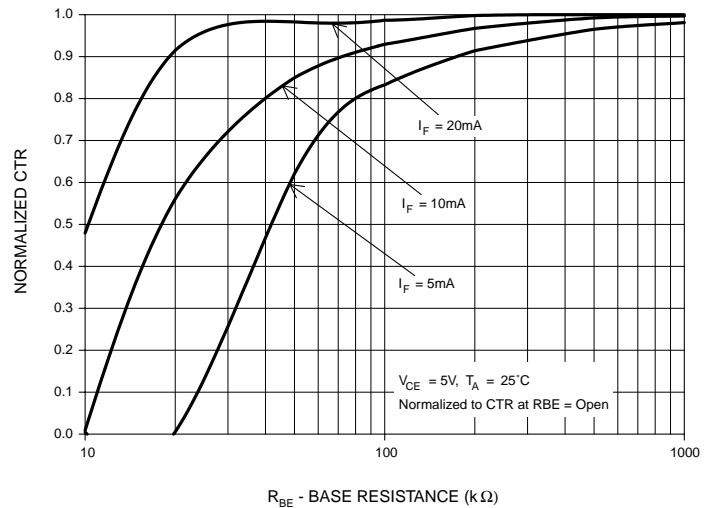

Fig. 7 CTR vs. R_{BE} (Unsaturated)



CNW11AV-1

CNW11AV-2

CNW11AV-3

Fig. 8 CTR vs. R_{BE} (Saturated)

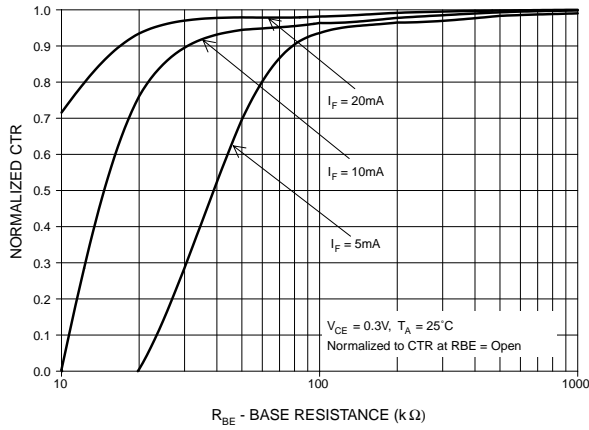

Fig. 9 Normalized t_{on} vs. R_{BE}

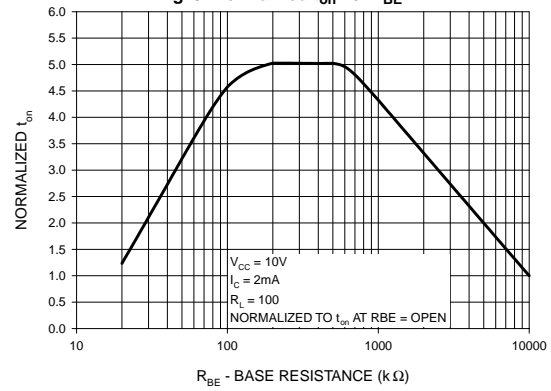

Fig. 10 Normalized t_{off} vs. R_{BE}

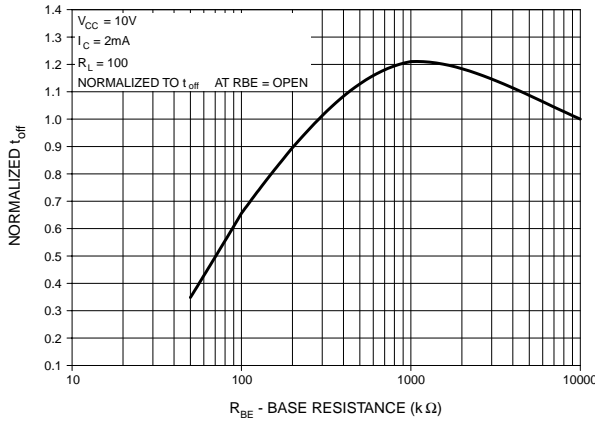

Fig. 11 Switching Speed vs. Load Resistor

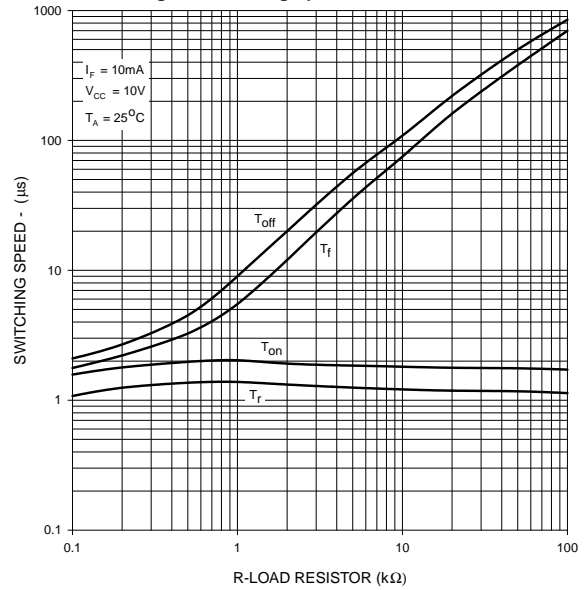

Fig. 12 Collector-Emitter Saturation Voltage vs Collector Current

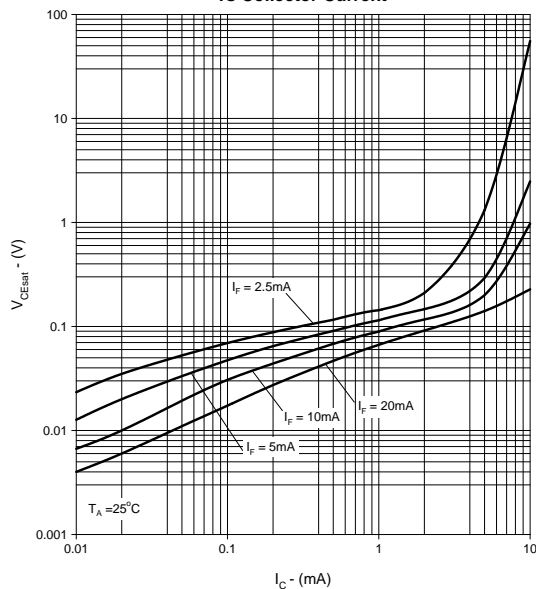
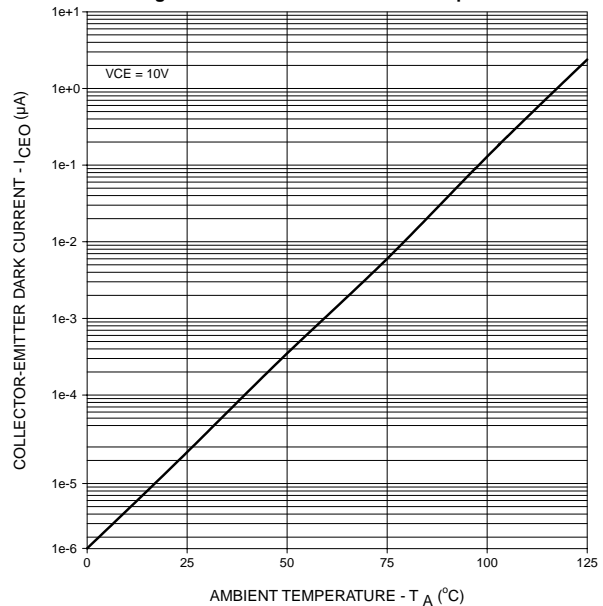
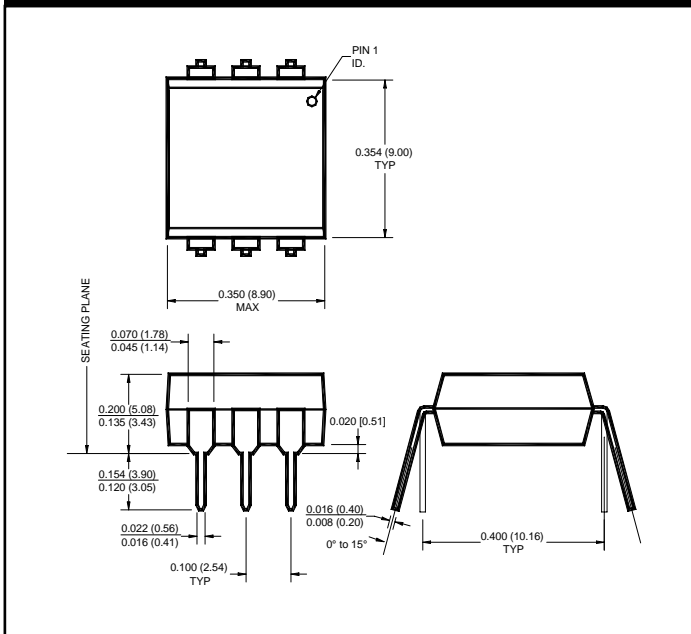

Fig. 13 Dark Current vs. Ambient Temperature



Package Dimensions (Through Hole)



Package Dimensions (Surface Mount)

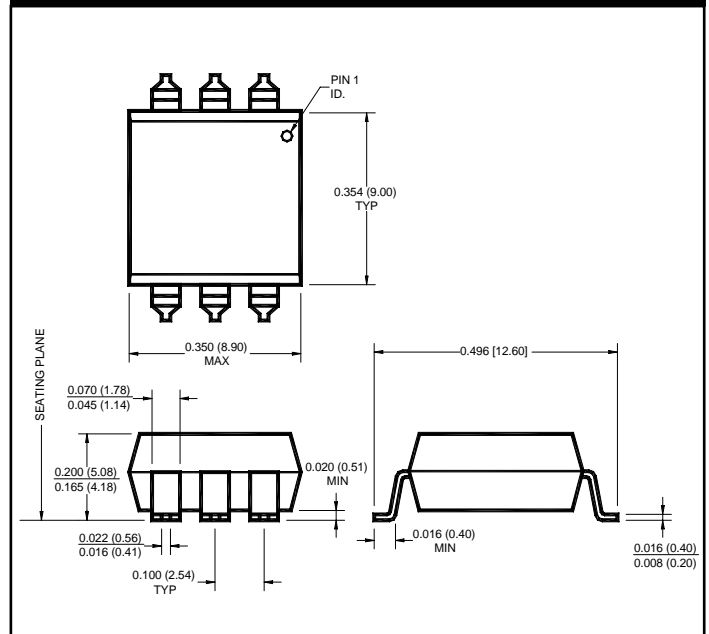

NOTE

All dimensions are in inches (millimeters)

CNW11AV-1 CNW11AV-2 CNW11AV-3

ORDERING INFORMATION

Option	Order Entry Identifier	Description
S	.S	Surface Mount Lead Bend
SD	.SD	Surface Mount; Tape and reel
300	.300	VDE 0884

Carrier Tape Specifications ("D" Taping Orientation)

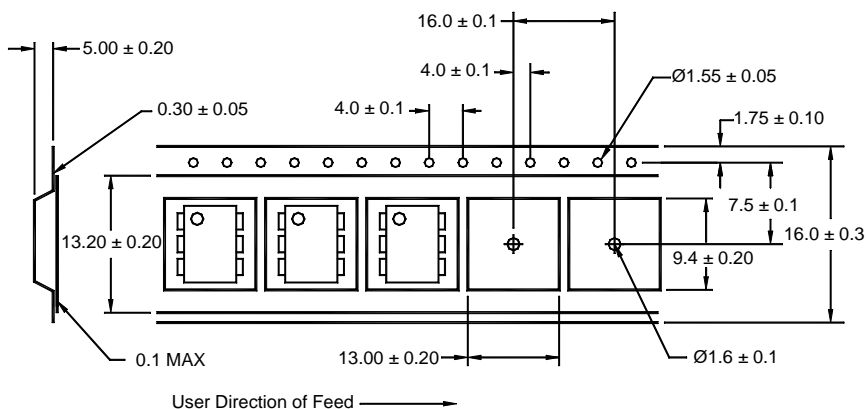

NOTE

All dimensions are in inches (millimeters)

DISCLAIMER

FAIRCHILD SEMICONDUCTOR RESERVES THE THE RIGHT TO MAKE CHANGES WITHOUT FURTHER NOTICE TO ANY PRODUCTS HEREIN TO IMPROVE RELIABILITY, FUNCTION OR DESIGN. FAIRCHILD DOES NOT ASSUME ANY LIABILITY ARISING OUT OF THE APPLICATION OR USE OF ANY PRODUCT OR CIRCUIT DESCRIBED HEREIN; NEITHER DOES IT CONVEY ANY LICENSE UNDER ITS PATENT RIGHTS, NOR THE RIGHTS OF OTHERS.

LIFE SUPPORT POLICY

FAIRCHILD'S PRODUCTS ARE NOT AUTHORIZED FOR USE AS CRITICAL COMPONENTS IN LIFE SUPPORT DEVICES OR SYSTEMS WITHOUT THE EXPRESS WRITTEN APPROVAL OF THE PRESIDENT OF FAIRCHILD SEMICONDUCTOR CORPORATION. As used herein:

1. Life support devices or systems are devices or systems which, (a) are intended for surgical implant into the body, or (b) support or sustain life, and (c) whose failure to perform when properly used in accordance with instructions for use provided in labeling, can be reasonably expected to result in a significant injury of the user.
2. A critical component in any component of a life support device or system whose failure to perform can be reasonably expected to cause the failure of the life support device or system, or to affect its safety or effectiveness.