

**APT6040BN 600V 18.0A 0.40Ω**

**APT6045BN 600V 17.0A 0.45Ω**

## POWER MOS IV®

### N-CHANNEL ENHANCEMENT MODE HIGH VOLTAGE POWER MOSFETS

#### MAXIMUM RATINGS

All Ratings:  $T_C = 25^\circ\text{C}$  unless otherwise specified.

| Symbol         | Parameter   | APT 6040BN | APT 6045BN | UNIT  |
|----------------|---|------------|------------|-------|
| $V_{DSS}$      | Drain-Source Voltage                                | 600        | 600        | Volts |
| $I_D$          | Continuous Drain Current @ $T_C = 25^\circ\text{C}$ | 18         | 17         | Amps  |
| $I_{DM}$       | Pulsed Drain Current <sup>①</sup>                   | 72         | 68         |       |
| $V_{GS}$       | Gate-Source Voltage                                 | $\pm 30$   |            | Volts |
| $P_D$          | Total Power Dissipation @ $T_C = 25^\circ\text{C}$  | 310        |            | Watts |
|                | Linear Derating Factor                              | 2.48       |            | W/°C  |
| $T_J, T_{STG}$ | Operating and Storage Junction Temperature Range    | -55 to 150 |            | °C    |
| $T_L$          | Lead Temperature: 0.063" from Case for 10 Sec.      | 300        |            |       |

#### STATIC ELECTRICAL CHARACTERISTICS

| Symbol       | Characteristic / Test Conditions / Part Number  | MIN       | TYP | MAX       | UNIT          |
|--------------|---|-----------|-----|-----------|---------------|
| $BV_{DSS}$   | Drain-Source Breakdown Voltage<br>( $V_{GS} = 0V, I_D = 250 \mu\text{A}$ )                            | APT6040BN | 600 |           | Volts         |
|              |   | APT6045BN | 600 |           |               |
| $I_{D(ON)}$  | On State Drain Current <sup>②</sup><br>( $V_{DS} > I_{D(ON)} \times R_{DS(ON)}$ Max, $V_{GS} = 10V$ ) | APT6040BN | 18  |           | Amps          |
|              |   | APT6045BN | 17  |           |               |
| $R_{DS(ON)}$ | Drain-Source On-State Resistance <sup>②</sup><br>( $V_{GS} = 10V, 0.5 I_D$ [Cont.])                   | APT6040BN |     | 0.40      | Ohms          |
|              |   | APT6045BN |     | 0.45      |               |
| $I_{DSS}$    | Zero Gate Voltage Drain Current ( $V_{DS} = V_{DSS}, V_{GS} = 0V$ )                                   |           |     | 250       | $\mu\text{A}$ |
|              | Zero Gate Voltage Drain Current ( $V_{DS} = 0.8 V_{DSS}, V_{GS} = 0V, T_C = 125^\circ\text{C}$ )      |           |     | 1000      |               |
| $I_{GSS}$    | Gate-Source Leakage Current ( $V_{GS} = \pm 30V, V_{DS} = 0V$ )                                       |           |     | $\pm 100$ | nA            |
| $V_{GS(TH)}$ | Gate Threshold Voltage ( $V_{DS} = V_{GS}, I_D = 1.0\text{mA}$ )                                      | 2         |     | 4         | Volts         |

#### THERMAL CHARACTERISTICS

| Symbol          | Characteristic      | MIN | TYP | MAX  | UNIT |
|-----------------|---------------------|-----|-----|------|------|
| $R_{\theta JC}$ | Junction to Case    |     |     | 0.40 | °C/W |
| $R_{\theta JA}$ | Junction to Ambient |     |     | 40   |      |

**CAUTION:** These Devices are Sensitive to Electrostatic Discharge. Proper Handling Procedures Should Be Followed.

USA

405 S.W. Columbia Street  
EUROPE

Avenue J.F. Kennedy Bât B4 Parc Cadéra Nord

Bend, Oregon 97702-1035

F-33700 Merignac - France

Phone: (541) 382-8028

Phone: (33) 5 57 92 15 15

FAX: (541) 388-0364

FAX: (33) 5 56 47 97 61

**DYNAMIC CHARACTERISTICS**

**APT6040/6045BN**

| Symbol            | Characteristic                 | Test Conditions  | MIN | TYP  | MAX  | UNIT |
|-------------------|--------------------------------|--|-----|------|------|------|
| $C_{iss}$         | Input Capacitance              | $V_{GS} = 0V$<br>$V_{DS} = 25V$<br>$f = 1\text{ MHz}$  |     | 2400 | 2950 | pF   |
| $C_{oss}$         | Output Capacitance             |  |     | 436  | 610  |      |
| $C_{rss}$         | Reverse Transfer Capacitance   |  |     | 154  | 230  |      |
| $Q_g$             | Total Gate Charge <sup>③</sup> | $V_{GS} = 10V$<br>$V_{DD} = 0.5 V_{DSS}$<br>$I_D = I_D [\text{Cont.}] @ 25^\circ\text{C}$                      |     | 87   | 130  | nC   |
| $Q_{gs}$          | Gate-Source Charge             |  |     | 11   | 16   |      |
| $Q_{gd}$          | Gate-Drain ("Miller") Charge   |  |     | 46   | 69   |      |
| $t_d(\text{on})$  | Turn-on Delay Time             | $V_{GS} = 15V$<br>$V_{DD} = 0.5 V_{DSS}$<br>$I_D = I_D [\text{Cont.}] @ 25^\circ\text{C}$<br>$R_G = 1.8\Omega$ |     | 14   | 28   | ns   |
| $t_r$             | Rise Time                      |  |     | 23   | 46   |      |
| $t_d(\text{off})$ | Turn-off Delay Time            |  |     | 63   | 95   |      |
| $t_f$             | Fall Time                      |  |     | 23   | 46   |      |

**SOURCE-DRAIN DIODE RATINGS AND CHARACTERISTICS**

| Symbol   | Characteristic / Test Conditions / Part Number                                  | MIN       | TYP | MAX | UNIT    |
|----------|---|-----------|-----|-----|---------|
| $I_S$    | Continuous Source Current (Body Diode)  | APT6040BN |     | 18  | Amps    |
|          |   | APT6045BN |     | 17  |         |
| $I_{SM}$ | Pulsed Source Current <sup>①</sup> (Body Diode)                                 | APT6040BN |     | 72  | Amps    |
|          |   | APT6045BN |     | 68  |         |
| $V_{SD}$ | Diode Forward Voltage <sup>②</sup> ( $V_{GS} = 0V, I_S = -I_D [\text{Cont.}]$ ) |           |     | 1.3 | Volts   |
| $t_{rr}$ | Reverse Recovery Time ( $I_S = -I_D [\text{Cont.}], di_S/dt = 100A/\mu s$ )     |           | 334 | 668 | ns      |
| $Q_{rr}$ | Reverse Recovery Charge ( $I_S = -I_D [\text{Cont.}], di_S/dt = 100A/\mu s$ )   |           | 5   | 10  | $\mu C$ |

**SAFE OPERATING AREA CHARACTERISTICS**

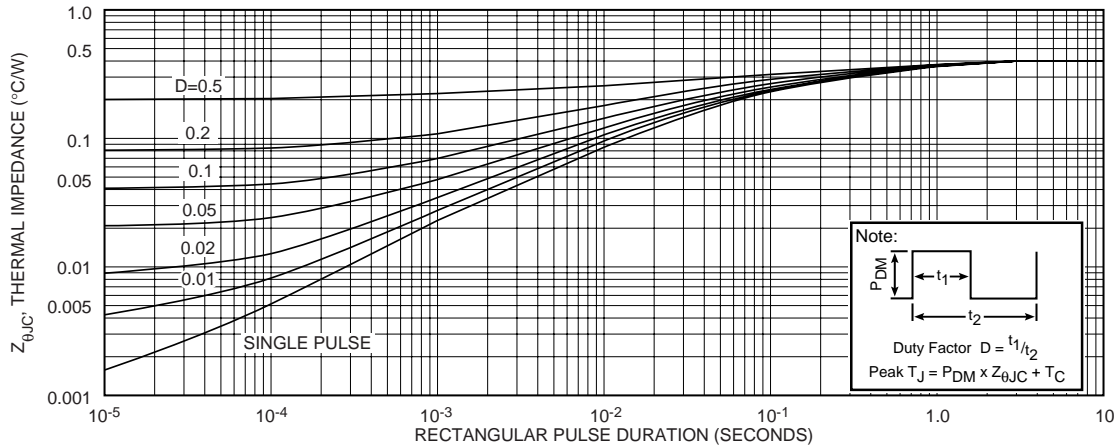
| Symbol   | Characteristic            | Test Conditions / Part Number   | MIN | TYP | MAX | UNIT  |
|----------|---------------------------|---|-----|-----|-----|-------|
| SOA1     | Safe Operating Area       | $V_{DS} = 0.4 V_{DSS}, I_{DS} = P_D / 0.4 V_{DSS}, t = 1\text{ Sec.}$               | 310 |     |     | Watts |
| SOA2     | Safe Operating Area       | $I_{DS} = I_D [\text{Cont.}], V_{DS} = P_D / I_D [\text{Cont.}], t = 1\text{ Sec.}$ | 310 |     |     |       |
| $I_{LM}$ | Inductive Current Clamped | APT6040BN   | 72  |     |     | Amps  |
|          |                           | APT6045BN   | 68  |     |     |       |

① Repetitive Rating: Pulse width limited by maximum junction temperature. See Transient Thermal Impedance Curve. (Fig.1)

② Pulse Test: Pulse width < 380  $\mu s$ , Duty Cycle < 2%

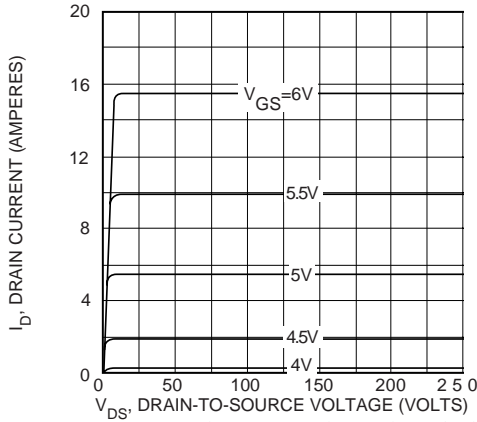
③ See MIL-STD-750 Method 3471

APT Reserves the right to change, without notice, the specifications and information contained herein.

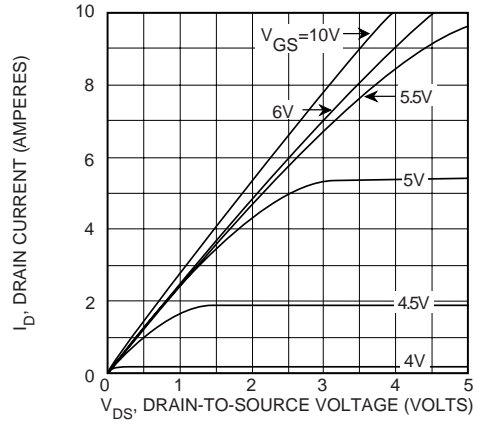


**FIGURE 1, MAXIMUM EFFECTIVE TRANSIENT THERMAL IMPEDANCE, JUNCTION-TO-CASE vs PULSE DURATION**

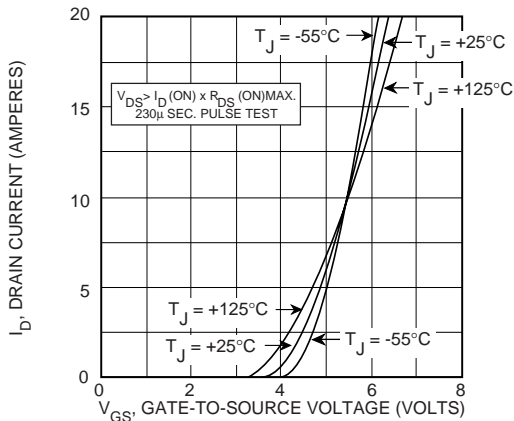
**APT6040/6045BN**



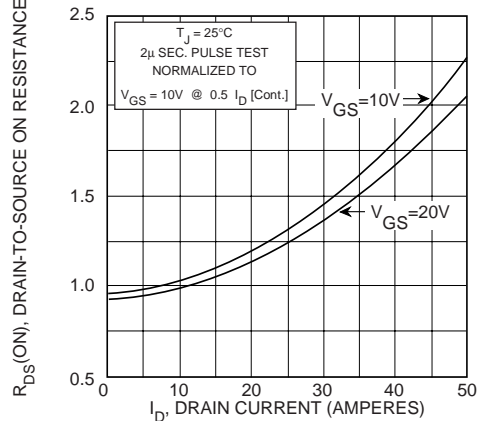
**FIGURE 2, TYPICAL OUTPUT CHARACTERISTICS**



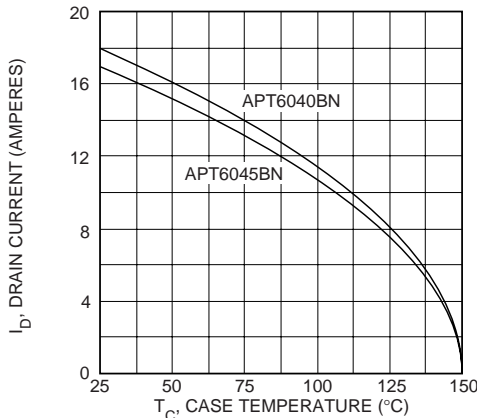
**FIGURE 3, TYPICAL OUTPUT CHARACTERISTICS**



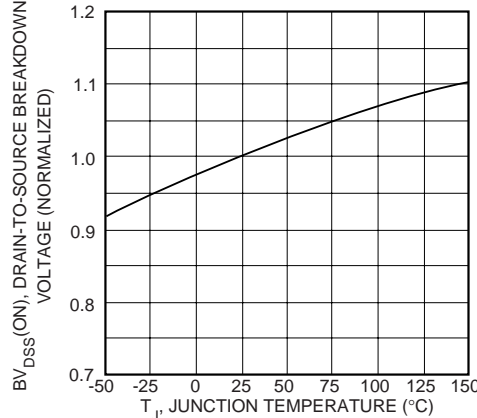
**FIGURE 4, TYPICAL TRANSFER CHARACTERISTICS**



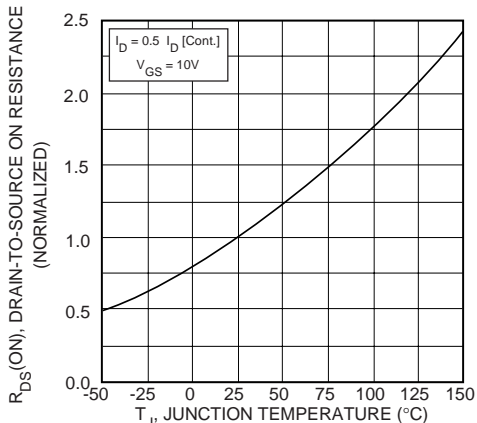
**FIGURE 5,  $R_{DS(ON)}$  vs DRAIN CURRENT**



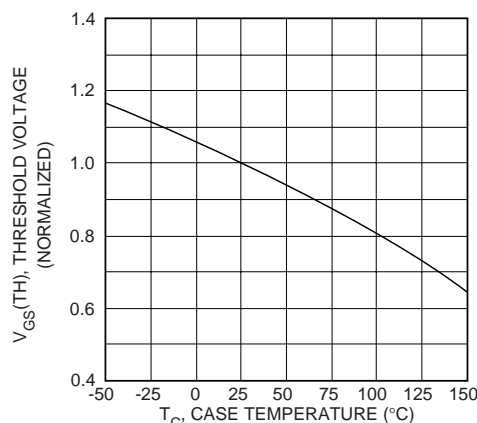
**FIGURE 6, MAXIMUM DRAIN CURRENT vs CASE TEMPERATURE**



**FIGURE 7, BREAKDOWN VOLTAGE vs TEMPERATURE**

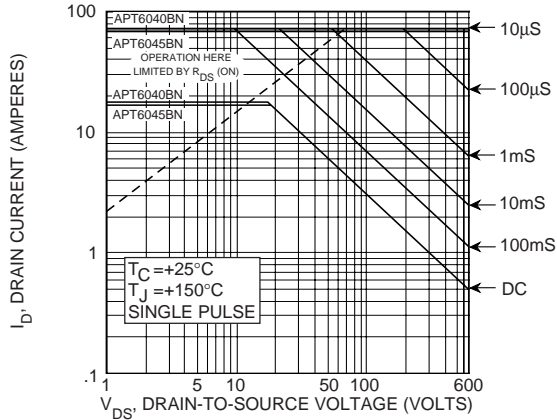


**FIGURE 8, ON-RESISTANCE vs. TEMPERATURE**

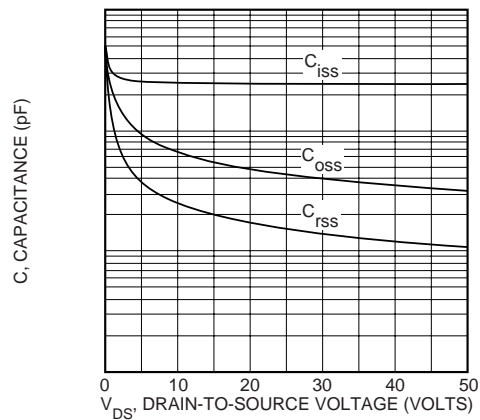


**FIGURE 9, THRESHOLD VOLTAGE vs TEMPERATURE**

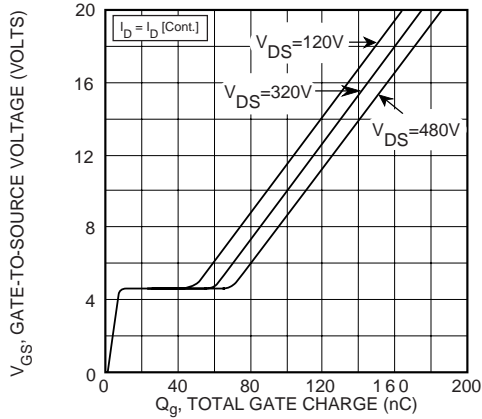
**APT6040/6045BN**



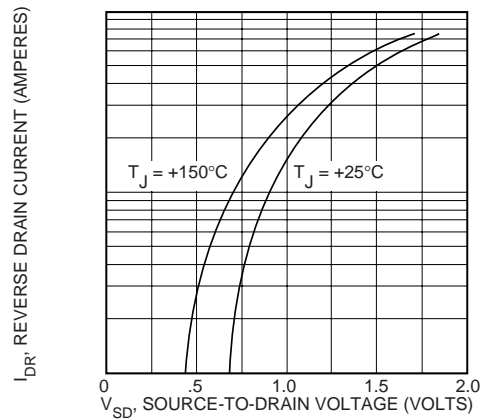
**FIGURE 10, MAXIMUM SAFE OPERATING AREA**



**FIGURE 11, TYPICAL CAPACITANCE vs DRAIN-TO-SOURCE VOLTAGE**

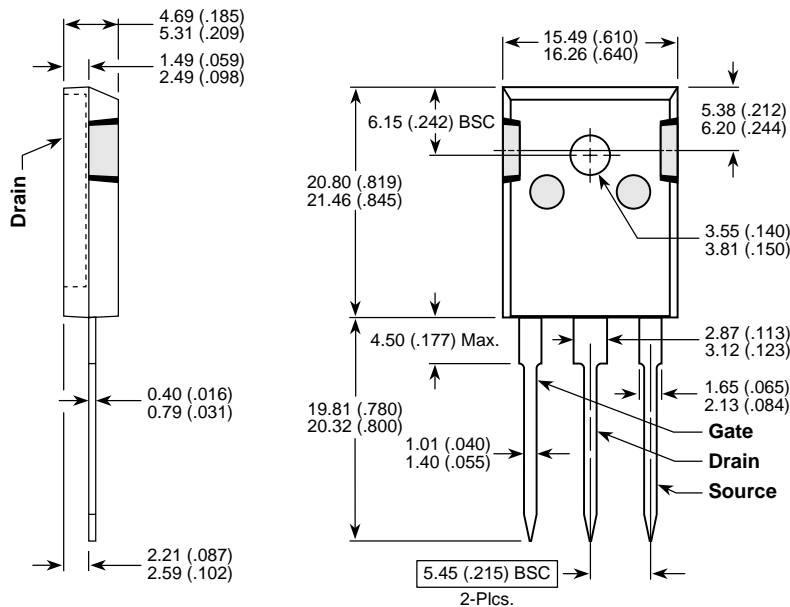


**FIGURE 12, GATE CHARGES vs GATE-TO-SOURCE VOLTAGE**



**FIGURE 13, TYPICAL SOURCE-DRAIN DIODE FORWARD VOLTAGE**

**TO-247AD Package Outline**



Dimensions in Millimeters and (Inches)