

## Features

- **AVR® – High-performance and Low-power RISC Architecture**
  - 118 Powerful Instructions – Most Single Clock Cycle Execution
  - 32 x 8 General-purpose Working Registers
  - Up to 8 MIPS Throughput at 8 MHz
- **Data and Nonvolatile Program Memories**
  - 4K/8K Bytes of In-System Programmable Flash
  - SPI Serial Interface for In-System Programming
  - Endurance: 1,000 Write/Erase Cycles
  - 256/512 Bytes EEPROM
  - Endurance: 100,000 Write/Erase Cycles
  - 256/512 Bytes Internal SRAM
  - Programming Lock for Software Security
- **Peripheral Features**
  - 8-channel, 10-bit ADC
  - Programmable UART
  - Master/Slave SPI Serial Interface
  - Two 8-bit Timer/Counters with Separate Prescaler and Compare Mode
  - One 16-bit Timer/Counter with Separate Prescaler, Compare and Capture Modes and Dual 8-, 9-, or 10-bit PWM
  - Programmable Watchdog Timer with On-chip Oscillator
  - On-chip Analog Comparator
- **Special Microcontroller Features**
  - Power-on Reset Circuit
  - Real-time Clock (RTC) with Separate Oscillator and Counter Mode
  - External and Internal Interrupt Sources
  - Three Sleep Modes: Idle, Power Save and Power-down
- **Power Consumption at 4 MHz, 3V, 20°C**
  - Active: 6.4 mA
  - Idle Mode: 1.9 mA
  - Power-down Mode: <1 µA
- **I/O and Packages**
  - 32 Programmable I/O Lines
  - 40-pin PDIP, 44-pin PLCC and 44-pin TQFP
- **Operating Voltages**
  - V<sub>CC</sub>: 4.0 - 6.0V AT90S4434/AT90S8535
  - V<sub>CC</sub>: 2.7 - 6.0V AT90LS4434/AT90LS8535
- **Speed Grades:**
  - 0 - 8 MHz AT90S4434/AT90S8535
  - 0 - 4 MHz AT90LS4434/AT90LS8535

## Pin Configurations

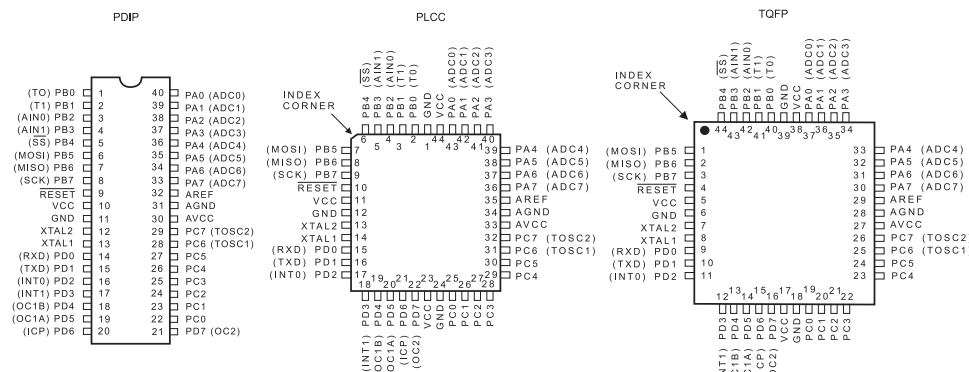

# 8-bit AVR® Microcontroller with 4K/8K Bytes In-System Programmable Flash

**AT90S4434**  
**AT90LS4434**  
**AT90S8535**  
**AT90LS8535**

**Preliminary**

**Summary**

Rev. 1041FS-10/00



Note: This is a summary document. A complete document is available on our web site at [www.atmel.com](http://www.atmel.com).

## Description

The AT90S4434/8535 is a low-power CMOS 8-bit microcontroller based on the AVR RISC architecture. By executing powerful instructions in a single clock cycle, the AT90S4434/8535 achieves throughputs approaching 1 MIPS per MHz allowing the system designer to optimize power consumption versus processing speed.

## Block Diagram

Figure 1. The AT90S4434/8535 Block Diagram

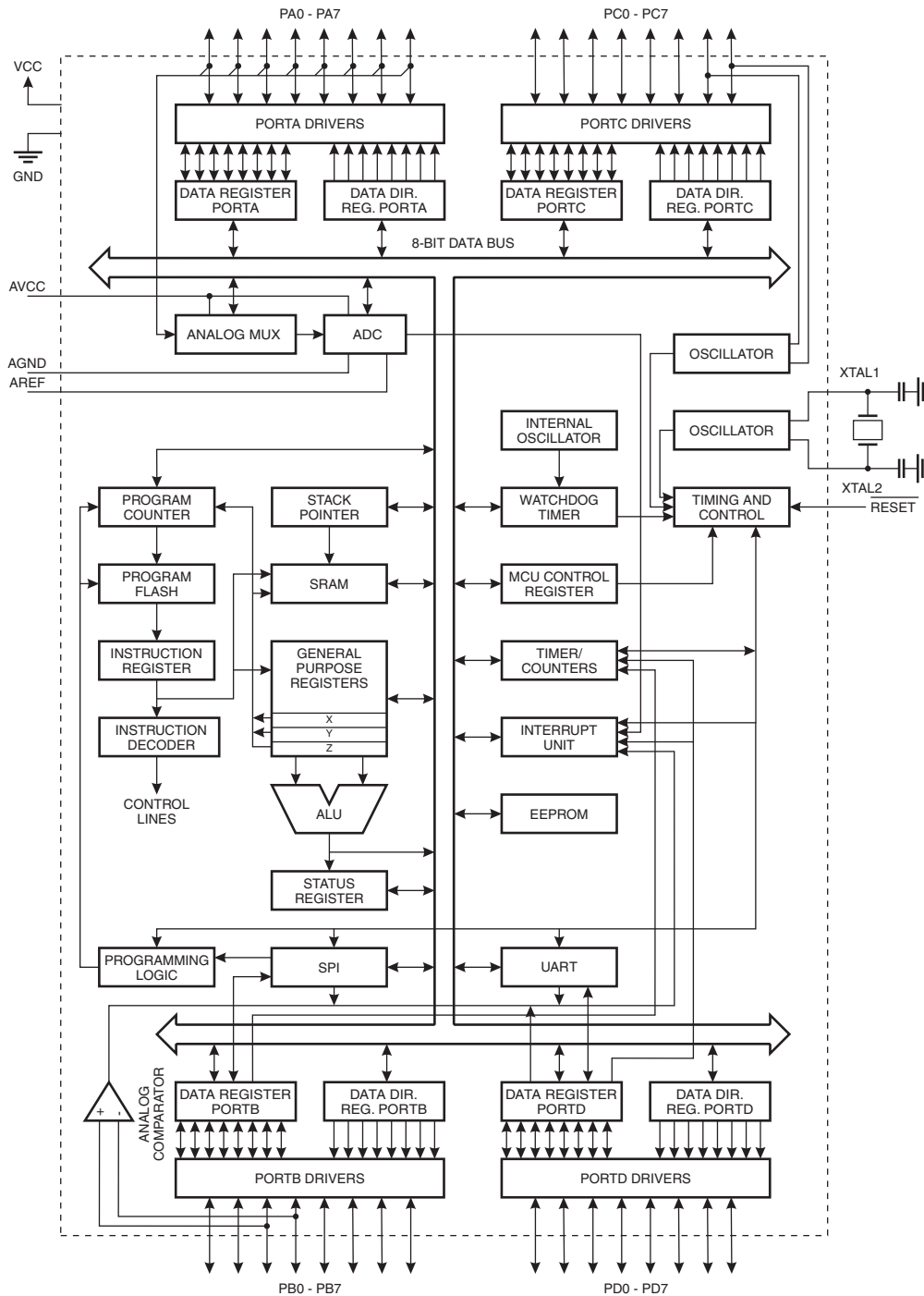

The AVR core combines a rich instruction set with 32 general-purpose working registers. All the 32 registers are directly connected to the Arithmetic Logic Unit (ALU), allowing two independent registers to be accessed in one single instruction executed in one clock cycle. The resulting architecture is more code efficient while achieving throughputs up to ten times faster than conventional CISC microcontrollers.

The AT90S4434/8535 provides the following features: 4K/8K bytes of In-System Programmable Flash, 256/512 bytes EEPROM, 256/512 bytes SRAM, 32 general-purpose I/O lines, 32 general-purpose working registers, Real-time Clock (RTC), three flexible timer/counters with compare modes, internal and external interrupts, a programmable serial UART, 8-channel, 10-bit ADC, programmable Watchdog Timer with internal oscillator, an SPI serial port and three software-selectable power-saving modes. The Idle Mode stops the CPU while allowing the SRAM, timer/counters, SPI port and interrupt system to continue functioning. The Power-down Mode saves the register contents but freezes the oscillator, disabling all other chip functions until the next interrupt or hardware reset. In Power Save Mode, the timer oscillator continues to run, allowing the user to maintain a timer base while the rest of the device is sleeping.

The device is manufactured using Atmel's high-density nonvolatile memory technology. The on-chip ISP Flash allows the program memory to be reprogrammed in-system through an SPI serial interface or by a conventional nonvolatile memory programmer. By combining an 8-bit RISC CPU with In-System Programmable Flash on a monolithic chip, the Atmel AT90S4434/8535 is a powerful microcontroller that provides a highly flexible and cost effective solution to many embedded control applications.

The AT90S4434/8535 AVR is supported with a full suite of program and system development tools including: C compilers, macro assemblers, program debugger/simulators, in-circuit emulators, and evaluation kits.

## Comparison between AT90S4434 and AT90S8535

The AT90S4434 has 4K bytes of In-System Programmable Flash, 256 bytes of EEPROM and 256 bytes of internal SRAM. The AT90S8535 has 8K bytes of In-System Programmable Flash, 512 bytes of EEPROM and 512 bytes of internal SRAM. Table 1 summarizes the different memory sizes for the two devices.

**Table 1.** Memory Size Summary

Part	Flash	EEPROM	SRAM
AT90S4434	4K bytes	256 bytes	256 bytes
AT90S8535	8K bytes	512 bytes	512 bytes

## Pin Descriptions

### VCC

Digital supply voltage

### GND

Digital ground

### Port A (PA7..PA0)

Port A is an 8-bit bi-directional I/O port. Port pins can provide internal pull-up resistors (selected for each bit). The Port A output buffers can sink 20 mA and can drive LED displays directly. When pins PA0 to PA7 are used as inputs and are externally pulled low, they will source current if the internal pull-up resistors are activated.

Port A also serves as the analog inputs to the A/D Converter.

The Port A pins are tri-stated when a reset condition becomes active, even if the clock is not running.

### Port B (PB7..PB0)

Port B is an 8-bit bi-directional I/O port with internal pull-up resistors. The Port B output buffers can sink 20 mA. As inputs, Port B pins that are externally pulled low will source current if the pull-up resistors are activated. Port B also serves the functions of various special features of the AT90S4434/8535 as listed on page 71.



The Port B pins are tri-stated when a reset condition becomes active, even if the clock is not running.

#### **Port C (PC7..PC0)**

Port C is an 8-bit bi-directional I/O port with internal pull-up resistors. The Port C output buffers can sink 20 mA. As inputs, Port C pins that are externally pulled low will source current if the pull-up resistors are activated. Two Port C pins can alternatively be used as oscillator for Timer/Counter2.

The Port C pins are tri-stated when a reset condition becomes active, even if the clock is not running.

#### **Port D (PD7..PD0)**

Port D is an 8-bit bi-directional I/O port with internal pull-up resistors. The Port D output buffers can sink 20 mA. As inputs, Port D pins that are externally pulled low will source current if the pull-up resistors are activated.

Port D also serves the functions of various special features of the AT90S4434/8535 as listed on page 79.

The Port D pins are tri-stated when a reset condition becomes active, even if the clock is not running.

#### **RESET**

Reset input. An external reset is generated by a low level on the  $\overline{\text{RESET}}$  pin. Reset pulses longer than 50 ns will generate a reset, even if the clock is not running. Shorter pulses are not guaranteed to generate a reset.

#### **XTAL1**

Input to the inverting oscillator amplifier and input to the internal clock operating circuit.

#### **XTAL2**

Output from the inverting oscillator amplifier.

#### **AVCC**

This is the supply voltage pin for Port A and the A/D Converter. If the ADC is not used, this pin must be connected to VCC. If the ADC is used, this pin must be connected to VCC via a low-pass filter. See page 61 for details on operation of the ADC.

#### **AREF**

This is the analog reference input for the A/D Converter. For ADC operations, a voltage in the range 2V to  $AV_{CC}$  must be applied to this pin.

#### **AGND**

Analog ground. If the board has a separate analog ground plane, this pin should be connected to this ground plane. Otherwise, connect to GND.

## Architectural Overview

The fast-access register file concept contains 32 x 8-bit general-purpose working registers with a single clock cycle access time. This means that during one single clock cycle, one Arithmetic Logic Unit (ALU) operation is executed. Two operands are output from the register file, the operation is executed and the result is stored back in the register file – in one clock cycle.

Six of the 32 registers can be used as three 16-bit indirect address register pointers for Data Space addressing, enabling efficient address calculations. One of the three address pointers is also used as the address pointer for the constant table look-up function. These added function registers are the 16-bit X-register, Y-register and Z-register.

**Figure 2.** The AT90S4434/8535 AVR RISC Architecture

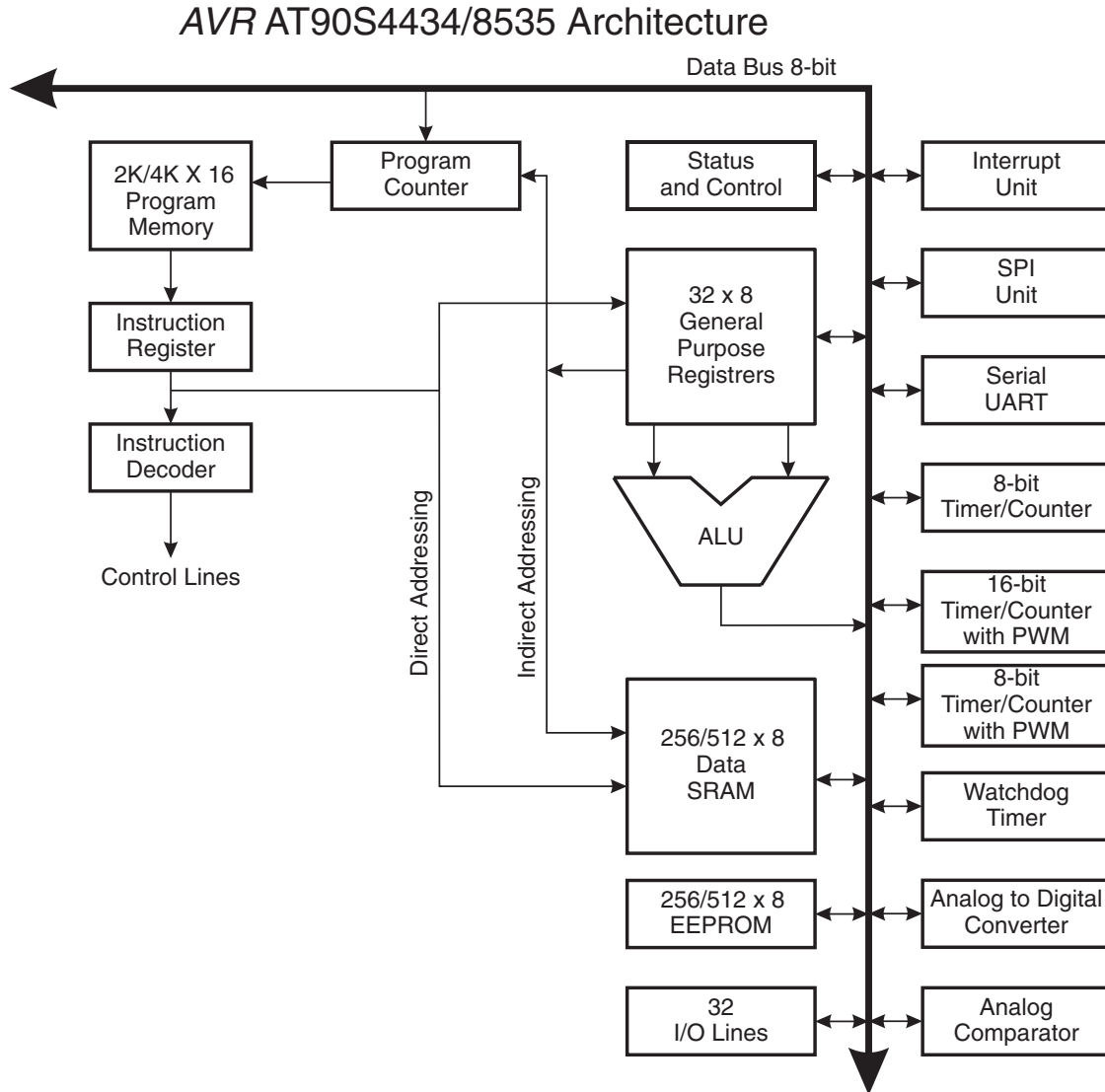

The ALU supports arithmetic and logic functions between registers or between a constant and a register. Single register operations are also executed in the ALU. Figure 2 shows the AT90S4434/8535 AVR RISC microcontroller architecture.

In addition to the register operation, the conventional memory addressing modes can be used on the register file as well. This is enabled by the fact that the register file is assigned the 32 lowermost Data Space addresses (\$00 - \$1F), allowing them to be accessed as though they were ordinary memory locations.

The I/O memory space contains 64 addresses for CPU peripheral functions as Control Registers, Timer/Counters, A/D converters and other I/O functions. The I/O memory can be accessed directly or as the Data Space locations following those of the register file, \$20 - \$5F.

The AVR uses a Harvard architecture concept – with separate memories and buses for program and data. The program memory is executed with a two-stage pipeline. While one instruction is being executed, the next instruction is pre-fetched from the program memory. This concept enables instructions to be executed in every clock cycle. The program memory is in-system downloadable Flash memory.

With the relative jump and call instructions, the whole 2K/4K address space is directly accessed. Most AVR instructions have a single 16-bit word format. Every program memory address contains a 16- or 32-bit instruction.

During interrupts and subroutine calls, the return address Program Counter (PC) is stored on the stack. The stack is effectively allocated in the general data SRAM and consequently, the stack size is only limited by the total SRAM size and the usage of the SRAM. All user programs must initialize the SP in the reset routine (before subroutines or interrupts are executed). The 9/10-bit stack pointer (SP) is read/write-accessible in the I/O space.

The 256/512 bytes data SRAM can be easily accessed through the five different addressing modes supported in the AVR architecture.

The memory spaces in the AVR architecture are all linear and regular memory maps.

**Figure 3. Memory Maps**

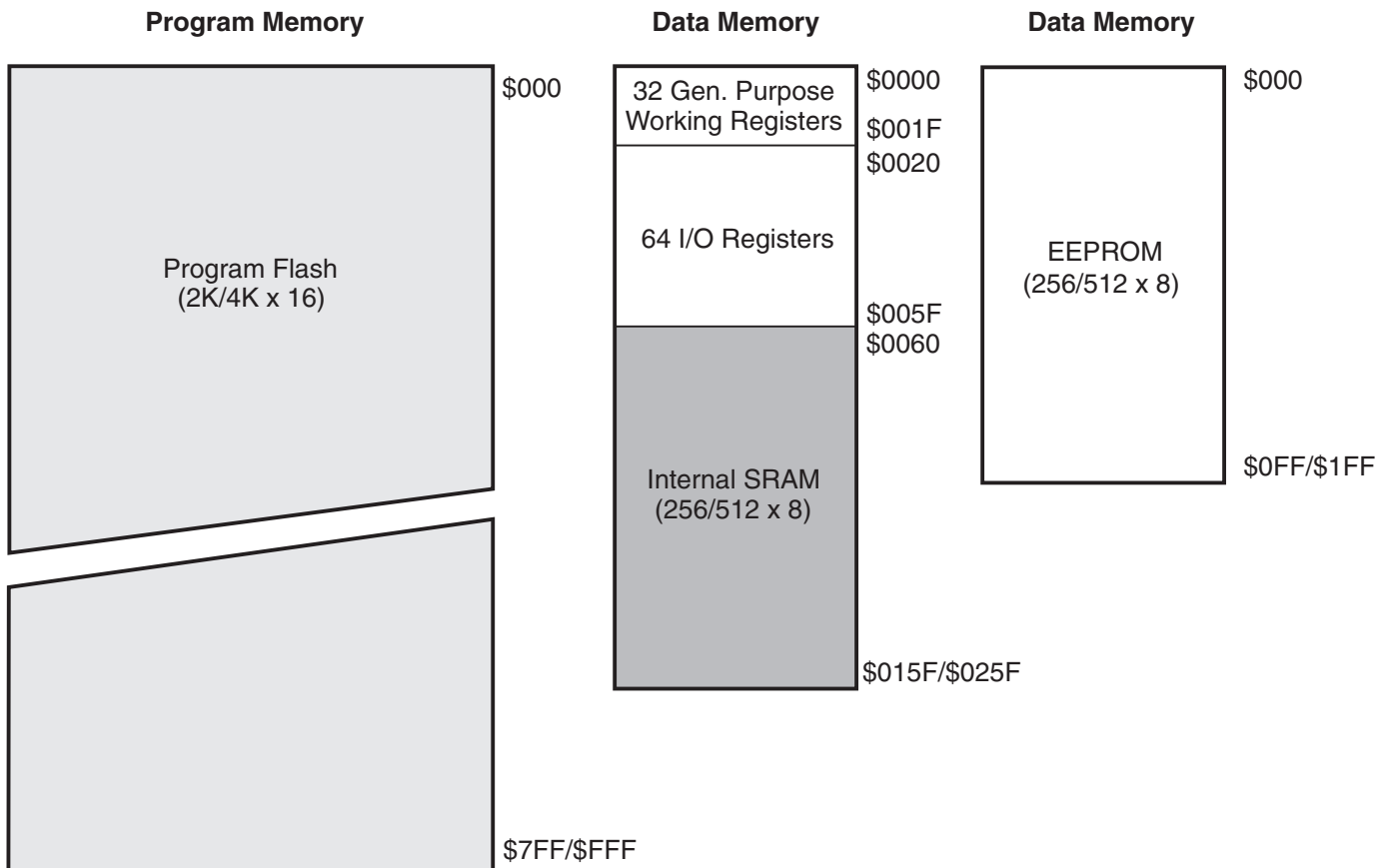

A flexible interrupt module has its control registers in the I/O space with an additional global interrupt enable bit in the status register. All the different interrupts have a separate interrupt vector in the interrupt vector table at the beginning of the program memory. The different interrupts have priority in accordance with their interrupt vector position. The lower the interrupt vector address, the higher the priority.

## Register Summary

Address	Name	Bit 7	Bit 6	Bit 5	Bit 4	Bit 3	Bit 2	Bit 1	Bit 0	Page	
\$3F (\$5F)	SREG	I	T	H	S	V	N	Z	C	page 18	
\$3E (\$5E)	SPH	-	-	-	-	-	-	SP9	SP8	page 18	
\$3D (\$5D)	SPL	SP7	SP6	SP5	SP4	SP3	SP2	SP1	SP0	page 18	
\$3C (\$5C)	Reserved										
\$3B (\$5B)	GIMSK	INT1	INT0	-	-	-	-	-	-	page 24	
\$3A (\$5A)	GIFR	INTF1	INTF0							page 25	
\$39 (\$59)	TIMSK	OCIE2	TOIE2	TICIE1	OCIE1A	OCIE1B	TOIE1	-	TOIE0	page 25	
\$38 (\$58)	TIFR	OCF2	TOV2	ICF1	OCF1A	OCF1B	TOV1	-	TOV0	page 26	
\$37 (\$57)	Reserved										
\$36 (\$56)	Reserved										
\$35 (\$55)	MCUCR	-	SE	SM1	SM0	ISC11	ISC10	ISC01	ISC00	page 27	
\$34 (\$54)	MCUSR	-	-	-	-	-	-	EXTRF	PORF	page 23	
\$33 (\$53)	TCCR0	-	-	-	-	-	CS02	CS01	CS00	page 32	
\$32 (\$52)	TCNT0	Timer/Counter0 (8 Bits)								page 32	
\$31 (\$51)	Reserved										
\$30 (\$50)	Reserved										
\$2F (\$4F)	TCCR1A	COM1A1	COM1A0	COM1B1	COM1B0	-	-	PWM11	PWM10	page 34	
\$2E (\$4E)	TCCR1B	ICNC1	ICES1	-	-	CTC1	CS12	CS11	CS10	page 35	
\$2D (\$4D)	TCNT1H	Timer/Counter1 – Counter Register High Byte								page 36	
\$2C (\$4C)	TCNT1L	Timer/Counter1 – Counter Register Low Byte								page 36	
\$2B (\$4B)	OCR1AH	Timer/Counter1 – Output Compare Register A High Byte								page 37	
\$2A (\$4A)	OCR1AL	Timer/Counter1 – Output Compare Register A Low Byte								page 37	
\$29 (\$49)	OCR1BH	Timer/Counter1 – Output Compare Register B High Byte								page 37	
\$28 (\$48)	OCR1BL	Timer/Counter1 – Output Compare Register B Low Byte								page 37	
\$27 (\$47)	ICR1H	Timer/Counter1 – Input Capture Register High Byte								page 37	
\$26 (\$46)	ICR1L	Timer/Counter1 – Input Capture Register Low Byte								page 37	
\$25 (\$45)	TCCR2	-	PWM2	COM21	COM20	CTC2	CS22	CS21	CS20	page 41	
\$24 (\$44)	TCNT2	Timer/Counter2 (8 Bits)								page 42	
\$23 (\$43)	OCR2	Timer/Counter2 Output Compare Register								page 42	
\$22 (\$42)	ASSR	-	-	-	-	AS2	TCN2UB	OCR2UB	TCR2UB	page 44	
\$21 (\$41)	WDTCSR	-	-	-	WDTOE	WDE	WDP2	WDP1	WDP0	page 46	
\$20 (\$40)	Reserved										
\$1F (\$3F)	EEARH									EEAR9	page 48
\$1E (\$3E)	EEARL	EEAR7	EEAR6	EEAR5	EEAR4	EEAR3	EEAR2	EEAR1	EEAR0	page 48	
\$1D (\$3D)	EEDR	EEPROM Data Register								page 48	
\$1C (\$3C)	EECR	-	-	-	-	EERIE	EEMWE	EEWE	EERE	page 48	
\$1B (\$3B)	PORTA	PORTA7	PORTA6	PORTA5	PORTA4	PORTA3	PORTA2	PORTA1	PORTA0	page 70	
\$1A (\$3A)	DDRA	DDA7	DDA6	DDA5	DDA4	DDA3	DDA2	DDA1	DDA0	page 70	
\$19 (\$39)	PINA	PINA7	PINA6	PINA5	PINA4	PINA3	PINA2	PINA1	PINA0	page 70	
\$18 (\$38)	PORTB	PORTB7	PORTB6	PORTB5	PORTB4	PORTB3	PORTB2	PORTB1	PORTB0	page 72	
\$17 (\$37)	DDRB	ddb7	ddb6	ddb5	ddb4	ddb3	ddb2	ddb1	ddb0	page 72	
\$16 (\$36)	PINB	PINB7	PINB6	PINB5	PINB4	PINB3	PINB2	PINB1	PINB0	page 72	
\$15 (\$35)	PORTC	PORTC7	PORTC6	PORTC5	PORTC4	PORTC3	PORTC2	PORTC1	PORTC0	page 77	
\$14 (\$34)	DDRC	DDC7	DDC6	DDC5	DDC4	DDC3	DDC2	DDC1	DDC0	page 77	
\$13 (\$33)	PINC	PINC7	PINC6	PINC5	PINC4	PINC3	PINC2	PINC1	PINC0	page 77	
\$12 (\$32)	PORTD	PORTD7	PORTD6	PORTD5	PORTD4	PORTD3	PORTD2	PORTD1	PORTD0	page 80	
\$11 (\$31)	DDRD	DDD7	DDD6	DDD5	DDD4	DDD3	DDD2	DDD1	DDD0	page 80	
\$10 (\$30)	PIND	PIND7	PIND6	PIND5	PIND4	PIND3	PIND2	PIND1	PIND0	page 80	
\$0F (\$2F)	SPDR	SPI Data Register								page 53	
\$0E (\$2E)	SPSR	SPIF	WCOL	-	-	-	-	-	-	page 53	
\$0D (\$2D)	SPCR	SPIE	SPE	DORD	MSTR	CPOL	CPHA	SPR1	SPR0	page 52	
\$0C (\$2C)	UDR	UART I/O Data Register								page 57	
\$0B (\$2B)	USR	RXC	TXC	UDRE	FE	OR	-	-	-	page 57	
\$0A (\$2A)	UCR	RXCIE	TXCIE	UDRIE	RXEN	TXEN	CHR9	RXB8	TXB8	page 58	
\$09 (\$29)	UBRR	UART Baud Rate Register								page 59	
\$08 (\$28)	ACSR	ACD	-	ACO	ACI	ACIE	ACIC	ACIS1	ACIS0	page 60	
\$07 (\$27)	ADMUX	-	-	-	-	-	MUX2	MUX1	MUX0	page 65	
\$06 (\$26)	ADCSR	ADEN	ADSC	ADFR	ADIF	ADIE	ADPS2	ADPS1	ADPS0	page 66	
\$05 (\$25)	ADCH	-	-	-	-	-	-	ADC9	ADC8	page 67	
\$04 (\$24)	ADCL	ADC7	ADC6	ADC5	ADC4	ADC3	ADC2	ADC1	ADC0	page 67	
\$03 (\$20)	Reserved										
\$02 (\$22)	Reserved										
\$01 (\$21)	Reserved										
\$00 (\$20)	Reserved										

- Notes:
- For compatibility with future devices, reserved bits should be written to zero if accessed. Reserved I/O memory addresses should never be written.
  - Some of the status flags are cleared by writing a logical "1" to them. Note that the CBI and SBI instructions will operate on all bits in the I/O register, writing a one back into any flag read as set, thus clearing the flag. The CBI and SBI instructions work with registers \$00 to \$1F only.





## Instruction Set Summary

Mnemonic	Operands	Description	Operation	Flags	# Clocks
<b>ARITHMETIC AND LOGIC INSTRUCTIONS</b>					
ADD	Rd, Rr	Add Two Registers	$Rd \leftarrow Rd + Rr$	Z,C,N,V,H	1
ADC	Rd, Rr	Add with Carry Two Registers	$Rd \leftarrow Rd + Rr + C$	Z,C,N,V,H	1
ADIW	Rdl, K	Add Immediate to Word	$Rdh:Rdl \leftarrow Rdh:Rdl + K$	Z,C,N,V,S	2
SUB	Rd, Rr	Subtract Two Registers	$Rd \leftarrow Rd - Rr$	Z,C,N,V,H	1
SUBI	Rd, K	Subtract Constant from Register	$Rd \leftarrow Rd - K$	Z,C,N,V,H	1
SBC	Rd, Rr	Subtract with Carry Two Registers	$Rd \leftarrow Rd - Rr - C$	Z,C,N,V,H	1
SBCI	Rd, K	Subtract with Carry Constant from Reg.	$Rd \leftarrow Rd - K - C$	Z,C,N,V,H	1
SBW	Rdl, K	Subtract Immediate from Word	$Rdh:Rdl \leftarrow Rdh:Rdl - K$	Z,C,N,V,S	2
AND	Rd, Rr	Logical AND Registers	$Rd \leftarrow Rd \bullet Rr$	Z,N,V	1
ANDI	Rd, K	Logical AND Register and Constant	$Rd \leftarrow Rd \bullet K$	Z,N,V	1
OR	Rd, Rr	Logical OR Registers	$Rd \leftarrow Rd \vee Rr$	Z,N,V	1
ORI	Rd, K	Logical OR Register and Constant	$Rd \leftarrow Rd \vee K$	Z,N,V	1
EOR	Rd, Rr	Exclusive OR Registers	$Rd \leftarrow Rd \oplus Rr$	Z,N,V	1
COM	Rd	One's Complement	$Rd \leftarrow \$FF - Rd$	Z,C,N,V	1
NEG	Rd	Two's Complement	$Rd \leftarrow \$00 - Rd$	Z,C,N,V,H	1
SBR	Rd, K	Set Bit(s) in Register	$Rd \leftarrow Rd \vee K$	Z,N,V	1
CBR	Rd, K	Clear Bit(s) in Register	$Rd \leftarrow Rd \bullet (\$FF - K)$	Z,N,V	1
INC	Rd	Increment	$Rd \leftarrow Rd + 1$	Z,N,V	1
DEC	Rd	Decrement	$Rd \leftarrow Rd - 1$	Z,N,V	1
TST	Rd	Test for Zero or Minus	$Rd \leftarrow Rd \bullet Rd$	Z,N,V	1
CLR	Rd	Clear Register	$Rd \leftarrow Rd \oplus Rd$	Z,N,V	1
SER	Rd	Set Register	$Rd \leftarrow \$FF$	None	1
<b>BRANCH INSTRUCTIONS</b>					
RJMP	k	Relative Jump	$PC \leftarrow PC + k + 1$	None	2
IJMP		Indirect Jump to (Z)	$PC \leftarrow Z$	None	2
RCALL	k	Relative Subroutine Call	$PC \leftarrow PC + k + 1$	None	3
ICALL		Indirect Call to (Z)	$PC \leftarrow Z$	None	3
RET		Subroutine Return	$PC \leftarrow STACK$	None	4
RETI		Interrupt Return	$PC \leftarrow STACK$	I	4
CPSE	Rd, Rr	Compare, Skip if Equal	if (Rd = Rr) $PC \leftarrow PC + 2$ or 3	None	1/2/3
CP	Rd, Rr	Compare	$Rd - Rr$	Z,N,V,C,H	1
CPC	Rd, Rr	Compare with Carry	$Rd - Rr - C$	Z,N,V,C,H	1
CPI	Rd, K	Compare Register with Immediate	$Rd - K$	Z,N,V,C,H	1
SBRC	Rr, b	Skip if Bit in Register Cleared	if (Rr(b) = 0) $PC \leftarrow PC + 2$ or 3	None	1/2/3
SBRS	Rr, b	Skip if Bit in Register is Set	if (Rr(b) = 1) $PC \leftarrow PC + 2$ or 3	None	1/2/3
SBIC	P, b	Skip if Bit in I/O Register Cleared	if (P(b) = 0) $PC \leftarrow PC + 2$ or 3	None	1/2/3
SBIS	P, b	Skip if Bit in I/O Register is Set	if (P(b) = 1) $PC \leftarrow PC + 2$ or 3	None	1/2/3
BRBS	s, k	Branch if Status Flag Set	if (SREG(s) = 1) then $PC \leftarrow PC + k + 1$	None	1/2
BRBC	s, k	Branch if Status Flag Cleared	if (SREG(s) = 0) then $PC \leftarrow PC + k + 1$	None	1/2
BREQ	k	Branch if Equal	if (Z = 1) then $PC \leftarrow PC + k + 1$	None	1/2
BRNE	k	Branch if Not Equal	if (Z = 0) then $PC \leftarrow PC + k + 1$	None	1/2
BRCS	k	Branch if Carry Set	if (C = 1) then $PC \leftarrow PC + k + 1$	None	1/2
BRCC	k	Branch if Carry Cleared	if (C = 0) then $PC \leftarrow PC + k + 1$	None	1/2
BRSH	k	Branch if Same or Higher	if (C = 0) then $PC \leftarrow PC + k + 1$	None	1/2
BRLO	k	Branch if Lower	if (C = 1) then $PC \leftarrow PC + k + 1$	None	1/2
BRMI	k	Branch if Minus	if (N = 1) then $PC \leftarrow PC + k + 1$	None	1/2
BRPL	k	Branch if Plus	if (N = 0) then $PC \leftarrow PC + k + 1$	None	1/2
BRGE	k	Branch if Greater or Equal, Signed	if (N $\oplus$ V = 0) then $PC \leftarrow PC + k + 1$	None	1/2
BRLT	k	Branch if Less Than Zero, Signed	if (N $\oplus$ V = 1) then $PC \leftarrow PC + k + 1$	None	1/2
BRHS	k	Branch if Half-carry Flag Set	if (H = 1) then $PC \leftarrow PC + k + 1$	None	1/2
BRHC	k	Branch if Half-carry Flag Cleared	if (H = 0) then $PC \leftarrow PC + k + 1$	None	1/2
BRTS	k	Branch if T-flag Set	if (T = 1) then $PC \leftarrow PC + k + 1$	None	1/2
BRTC	k	Branch if T-flag Cleared	if (T = 0) then $PC \leftarrow PC + k + 1$	None	1/2
BRVS	k	Branch if Overflow Flag is Set	if (V = 1) then $PC \leftarrow PC + k + 1$	None	1/2
BRVC	k	Branch if Overflow Flag is Cleared	if (V = 0) then $PC \leftarrow PC + k + 1$	None	1/2
BRIE	k	Branch if Interrupt Enabled	if (I = 1) then $PC \leftarrow PC + k + 1$	None	1/2
BRID	k	Branch if Interrupt Disabled	if (I = 0) then $PC \leftarrow PC + k + 1$	None	1/2
<b>DATA TRANSFER INSTRUCTIONS</b>					
MOV	Rd, Rr	Move between Registers	$Rd \leftarrow Rr$	None	1
LDI	Rd, K	Load Immediate	$Rd \leftarrow K$	None	1
LD	Rd, X	Load Indirect	$Rd \leftarrow (X)$	None	2
LD	Rd, X+	Load Indirect and Post-inc.	$Rd \leftarrow (X), X \leftarrow X + 1$	None	2
LD	Rd, -X	Load Indirect and Pre-dec.	$X \leftarrow X - 1, Rd \leftarrow (X)$	None	2



## Instruction Set Summary (Continued)

Mnemonic	Operands	Description	Operation	Flags	# Clocks
LD	Rd, Y	Load Indirect	$Rd \leftarrow (Y)$	None	2
LD	Rd, Y+	Load Indirect and Post-inc.	$Rd \leftarrow (Y), Y \leftarrow Y + 1$	None	2
LD	Rd, -Y	Load Indirect and Pre-dec.	$Y \leftarrow Y - 1, Rd \leftarrow (Y)$	None	2
LDD	Rd, Y+q	Load Indirect with Displacement	$Rd \leftarrow (Y + q)$	None	2
LD	Rd, Z	Load Indirect	$Rd \leftarrow (Z)$	None	2
LD	Rd, Z+	Load Indirect and Post-inc.	$Rd \leftarrow (Z), Z \leftarrow Z + 1$	None	2
LD	Rd, -Z	Load Indirect and Pre-dec.	$Z \leftarrow Z - 1, Rd \leftarrow (Z)$	None	2
LDD	Rd, Z+q	Load Indirect with Displacement	$Rd \leftarrow (Z + q)$	None	2
LDS	Rd, k	Load Direct from SRAM	$Rd \leftarrow (k)$	None	2
ST	X, Rr	Store Indirect	$(X) \leftarrow Rr$	None	2
ST	X+, Rr	Store Indirect and Post-inc.	$(X) \leftarrow Rr, X \leftarrow X + 1$	None	2
ST	-X, Rr	Store Indirect and Pre-dec.	$X \leftarrow X - 1, (X) \leftarrow Rr$	None	2
ST	Y, Rr	Store Indirect	$(Y) \leftarrow Rr$	None	2
ST	Y+, Rr	Store Indirect and Post-inc.	$(Y) \leftarrow Rr, Y \leftarrow Y + 1$	None	2
ST	-Y, Rr	Store Indirect and Pre-dec.	$Y \leftarrow Y - 1, (Y) \leftarrow Rr$	None	2
STD	Y+q, Rr	Store Indirect with Displacement	$(Y + q) \leftarrow Rr$	None	2
ST	Z, Rr	Store Indirect	$(Z) \leftarrow Rr$	None	2
ST	Z+, Rr	Store Indirect and Post-inc.	$(Z) \leftarrow Rr, Z \leftarrow Z + 1$	None	2
ST	-Z, Rr	Store Indirect and Pre-dec.	$Z \leftarrow Z - 1, (Z) \leftarrow Rr$	None	2
STD	Z+q, Rr	Store Indirect with Displacement	$(Z + q) \leftarrow Rr$	None	2
STS	k, Rr	Store Direct to SRAM	$(k) \leftarrow Rr$	None	2
LPM		Load Program Memory	$R0 \leftarrow (Z)$	None	3
IN	Rd, P	In Port	$Rd \leftarrow P$	None	1
OUT	P, Rr	Out Port	$P \leftarrow Rr$	None	1
PUSH	Rr	Push Register on Stack	$STACK \leftarrow Rr$	None	2
POP	Rd	Pop Register from Stack	$Rd \leftarrow STACK$	None	2
<b>BIT AND BIT-TEST INSTRUCTIONS</b>					
SBI	P, b	Set Bit in I/O Register	$I/O(P,b) \leftarrow 1$	None	2
CBI	P, b	Clear Bit in I/O Register	$I/O(P,b) \leftarrow 0$	None	2
LSL	Rd	Logical Shift Left	$Rd(n+1) \leftarrow Rd(n), Rd(0) \leftarrow 0$	Z,C,N,V	1
LSR	Rd	Logical Shift Right	$Rd(n) \leftarrow Rd(n+1), Rd(7) \leftarrow 0$	Z,C,N,V	1
ROL	Rd	Rotate Left through Carry	$Rd(0) \leftarrow C, Rd(n+1) \leftarrow Rd(n), C \leftarrow Rd(7)$	Z,C,N,V	1
ROR	Rd	Rotate Right through Carry	$Rd(7) \leftarrow C, Rd(n) \leftarrow Rd(n+1), C \leftarrow Rd(0)$	Z,C,N,V	1
ASR	Rd	Arithmetic Shift Right	$Rd(n) \leftarrow Rd(n+1), n = 0..6$	Z,C,N,V	1
SWAP	Rd	Swap Nibbles	$Rd(3..0) \leftarrow Rd(7..4), Rd(7..4) \leftarrow Rd(3..0)$	None	1
BSET	s	Flag Set	$SREG(s) \leftarrow 1$	SREG(s)	1
BCLR	s	Flag Clear	$SREG(s) \leftarrow 0$	SREG(s)	1
BST	Rr, b	Bit Store from Register to T	$T \leftarrow Rr(b)$	T	1
BLD	Rd, b	Bit Load from T to Register	$Rd(b) \leftarrow T$	None	1
SEC		Set Carry	$C \leftarrow 1$	C	1
CLC		Clear Carry	$C \leftarrow 0$	C	1
SEN		Set Negative Flag	$N \leftarrow 1$	N	1
CLN		Clear Negative Flag	$N \leftarrow 0$	N	1
SEZ		Set Zero Flag	$Z \leftarrow 1$	Z	1
CLZ		Clear Zero Flag	$Z \leftarrow 0$	Z	1
SEI		Global Interrupt Enable	$I \leftarrow 1$	I	1
CLI		Global Interrupt Disable	$I \leftarrow 0$	I	1
SES		Set Signed Test Flag	$S \leftarrow 1$	S	1
CLS		Clear Signed Test Flag	$S \leftarrow 0$	S	1
SEV		Set Two's Complement Overflow	$V \leftarrow 1$	V	1
CLV		Clear Two's Complement Overflow	$V \leftarrow 0$	V	1
SET		Set T in SREG	$T \leftarrow 1$	T	1
CLT		Clear T in SREG	$T \leftarrow 0$	T	1
SEH		Set Half-carry Flag in SREG	$H \leftarrow 1$	H	1
CLH		Clear Half-carry Flag in SREG	$H \leftarrow 0$	H	1
NOP		No Operation		None	1
SLEEP		Sleep	(see specific descr. for Sleep function)	None	3
WDR		Watchdog Reset	(see specific descr. for WDR/timer)	None	1



## Ordering Information

Power Supply	Speed (MHz)	Ordering Code	Package	Operation Range
2.7 - 6.0V	4	AT90LS4434-4AC	44A	Commercial (0°C to 70°C)
		AT90LS4434-4JC	44J	
		AT90LS4434-4PC	40P6	
	4	AT90LS4434-4AI	44A	Industrial (-40°C to 85°C)
		AT90LS4434-4JI	44J	
		AT90LS4434-4PI	40P6	
4.0 - 6.0V	8	AT90S4434-8AC	44A	Commercial (0°C to 70°C)
		AT90S4434-8JC	44J	
		AT90S4434-8PC	40P6	
	8	AT90S4434-8AI	44A	Industrial (-40°C to 85°C)
		AT90S4434-8JI	44J	
		AT90S4434-8PI	40P6	
2.7 - 6.0V	4	AT90LS8535-4AC	44A	Commercial (0°C to 70°C)
		AT90LS8535-4JC	44J	
		AT90LS8535-4PC	40P6	
	4	AT90LS8535-4AI	44A	Industrial (-40°C to 85°C)
		AT90LS8535-4JI	44J	
		AT90LS8535-4PI	40P6	
4.0 - 6.0V	8	AT90S8535-8AC	44A	Commercial (0°C to 70°C)
		AT90S8535-8JC	44J	
		AT90S8535-8PC	40P6	
	8	AT90S8535-8AI	44A	Industrial (-40°C to 85°C)
		AT90S8535-8JI	44J	
		AT90S8535-8PI	40P6	

Package Type	
<b>44A</b>	44-lead, Thin (1.0 mm) Plastic Gull Wing Quad Flat Package (TQFP)
<b>44J</b>	44-lead, Plastic J-leaded Chip Carrier (PLCC)
<b>40P6</b>	40-lead, 0.600" Wide, Plastic Dual Inline Package (PDIP)

Packaging Information

**44A**, 44-lead, Thin (1.0 mm) Plastic Gull Wing Quad Flat Package (TQFP)  
 Dimensions in Millimeters and (Inches)

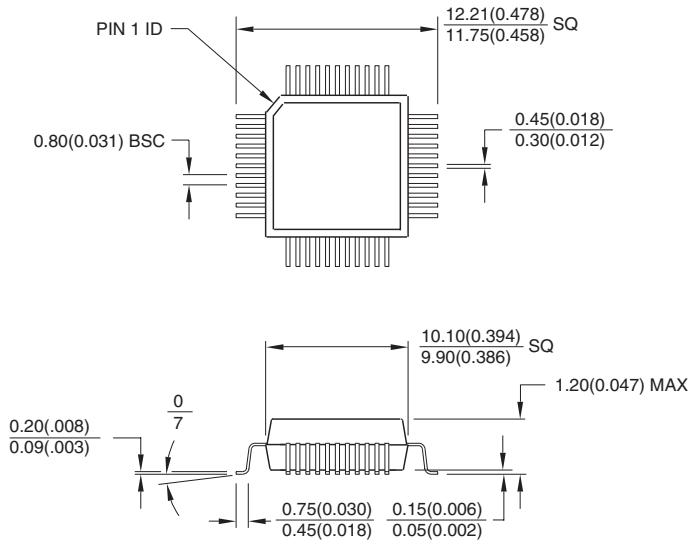

\*Controlling dimension: millimeters

**44J**, 44-lead, Plastic J-leaded Chip Carrier (PLCC)  
 Dimensions in Inches and (Millimeters)

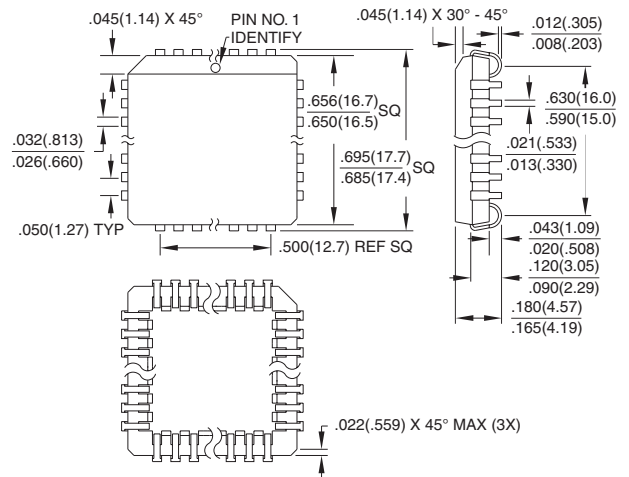

**40P6**, 40-lead, 0.600" Wide, Plastic Dual Inline Package (PDIP)  
 Dimensions in Inches and (Millimeters)  
 JEDEC STANDARD MS-011 AC

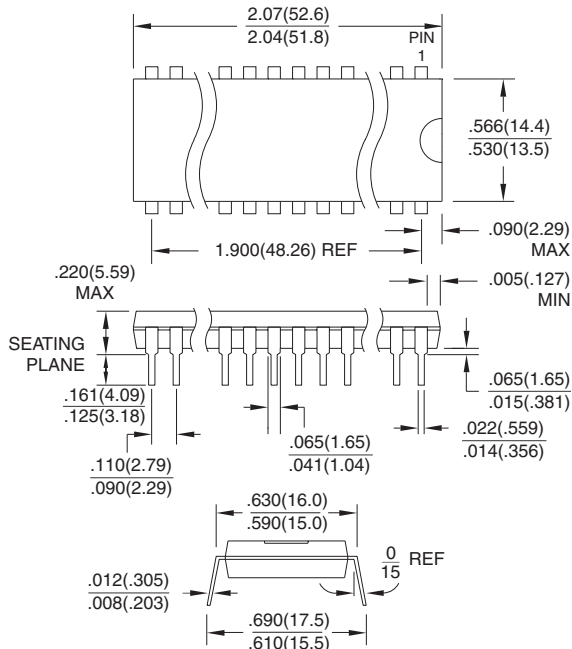



## Atmel Headquarters

*Corporate Headquarters*  
2325 Orchard Parkway  
San Jose, CA 95131  
TEL (408) 441-0311  
FAX (408) 487-2600

### *Europe*

Atmel SarL  
Route des Arsenaux 41  
Casa Postale 80  
CH-1705 Fribourg  
Switzerland  
TEL (41) 26-426-5555  
FAX (41) 26-426-5500

### *Asia*

Atmel Asia, Ltd.  
Room 1219  
Chinachem Golden Plaza  
77 Mody Road Tsimhatsui  
East Kowloon  
Hong Kong  
TEL (852) 2721-9778  
FAX (852) 2722-1369

### *Japan*

Atmel Japan K.K.  
9F, Tonetsu Shinkawa Bldg.  
1-24-8 Shinkawa  
Chuo-ku, Tokyo 104-0033  
Japan  
TEL (81) 3-3523-3551  
FAX (81) 3-3523-7581

## Atmel Operations

*Atmel Colorado Springs*  
1150 E. Cheyenne Mtn. Blvd.  
Colorado Springs, CO 80906  
TEL (719) 576-3300  
FAX (719) 540-1759

*Atmel Rousset*  
Zone Industrielle  
13106 Rousset Cedex  
France  
TEL (33) 4-4253-6000  
FAX (33) 4-4253-6001

*Atmel Smart Card ICs*  
Scottish Enterprise Technology Park  
East Kilbride, Scotland G75 0QR  
TEL (44) 1355-803-000  
FAX (44) 1355-242-743

*Atmel Grenoble*  
Avenue de Rochepleine  
BP 123  
38521 Saint-Egreve Cedex  
France  
TEL (33) 4-7658-3000  
FAX (33) 4-7658-3480

---

### *Fax-on-Demand*

North America:  
1-(800) 292-8635  
International:  
1-(408) 441-0732

*e-mail*  
literature@atmel.com

*Web Site*  
<http://www.atmel.com>

*BBS*  
1-(408) 436-4309

### © Atmel Corporation 2000.

Atmel Corporation makes no warranty for the use of its products, other than those expressly contained in the Company's standard warranty which is detailed in Atmel's Terms and Conditions located on the Company's web site. The Company assumes no responsibility for any errors which may appear in this document, reserves the right to change devices or specifications detailed herein at any time without notice, and does not make any commitment to update the information contained herein. No licenses to patents or other intellectual property of Atmel are granted by the Company in connection with the sale of Atmel products, expressly or by implication. Atmel's products are not authorized for use as critical components in life support devices or systems.

Marks bearing ® and/or ™ are registered trademarks and trademarks of Atmel Corporation.

Terms and product names in this document may be trademarks of others.



Printed on recycled paper.

1041FS-10/00/xM