



Operation Manual

Oil-Air Cooling Unit OL 4503



Version 2.0

Laird Technologies GmbH
Borsigstrasse 1
D-24568 Kaltenkirchen
www.lairdtech.com

Protection Notice

Dissemination as well as copying of this document, utilization or posting of its contents is not permitted unless formally granted. Violations entail claims for compensation. All copyrights, including rights due to patent grant or registration of a utility model or design, are reserved.

All product names used in this manual are trademarks of the corresponding manufacturers.

Technical modifications subject to change.

Table of Contents

- 1 About this Manual 6
 - 1.1 Terms of Guarantee.....6
 - 1.2 Contact Information.....7

- 2 Product Identification..... 8
 - 2.1 Unit Specifications.....8
 - 2.2 Identification Plate8

- 3 Safety Regulations..... 9
 - 3.1 Hazard classes.....9
 - 3.2 Safety Symbols9
 - 3.3 Hints for Safe Operation 10
 - 3.3.1 Prevent Hazards 10
 - 3.3.2 Hints Regarding the Electrical Equipment..... 10
 - 3.3.3 Environmental Issues..... 11
 - 3.3.4 Protective Clothing..... 11
 - 3.4 Safety Equipment..... 11
 - 3.4.1 Safety and Signalling Equipment included in the Unit..... 11
 - 3.4.2 Guards..... 12
 - 3.4.3 Caution Label 13
 - 3.5 In Case of Accidents..... 13

- 4 Product Description 14
 - 4.1 Intended Use 14
 - 4.2 Non-Conformity with the Intended Use..... 14
 - 4.3 Unit Components..... 15
 - 4.4 Specifications..... 16
 - 4.5 Setting-up Requirements..... 17
 - 4.5.1 Installation Location..... 17
 - 4.5.2 Environmental Conditions 17
 - 4.5.3 Infrastructure 17

- 5 Transport..... 18
 - 5.1 Safety Indications for Transport and Setting-up 18
 - 5.2 Transportation of the unit..... 18
 - 5.3 Unpacking..... 18

6	Initial Operation.....	19
6.1	Safety Indications Related to Initial Operation	19
6.2	Setting to Work	19
6.2.1	Placement	19
6.2.2	Cooling Circuit Connection and Filling.....	20
6.2.3	Electrical Connections	22
6.2.4	Carrying out Setting-to-Work	23
6.3	Daily Start-up	23
6.4	Setting-to-Work after Storage.....	23
7	Controlling the Unit	24
7.1	Safety Indications for Controlling the Unit	24
7.2	Switching on the Unit	24
7.3	Switching off the Unit	24
7.4	Settings.....	25
7.4.1	Pressure Setting on the Angle-type Safety Valve	25
7.4.2	Setting the Thermostat.....	26
8	Disruptions.....	27
8.1	Disrupt Operation.....	27
8.1.1	Trouble Shooting.....	27
9	Maintenance and Cleaning	28
9.1	Maintenance Schedule	28
9.2	Cleaning of Heat Exchanger.....	28
9.3	Refilling of Coolant.....	28
9.4	Cleaning of Unit Casing	29
10	Repair	29
11	Dismounting, Disposal, Storage.....	30
11.1	Temporary Placing out of Operation.....	30
11.2	Re-packaging the Unit.....	30
11.3	Storing the Unit.....	30
11.4	Disposal.....	31
11.5	Disposal of Operating Materials.....	31
11.6	Return of the Unit to LAIRD	31
12	Wear Parts and Spare Parts	32

Addendum 34

 Performance chart 34

 Flow scheme 35

 Wiring diagram..... 36

History of Changes

Date	Index	Reason for Change	Name	Page
29-Nov-13	1.0	First version	Edom/Pfeiffer	
06-Jul-15	2.0	Spare part numbers changed	Dany/Bitenaite	p. 33

1 About this Manual

This document is the English translation of the original Operation Manual in German language for the Oil-Air Cooling Unit OL 4503 (called unit in the following). It is based on German safety regulations. In your country other regulations may apply.

This Operational Manual addresses the needs of the user of the unit. Its intention is to allow the safe operation of the unit. Thus, it should be read carefully and be kept in a space accessible for the users of the unit at any time.

All chapters of this Operation Manual can be read independently and thus can be used for look-up purposes.

1.1 Terms of Guarantee

General sale and delivery terms of LAIRD apply. The buyer accepts these terms, at the latest when signing the contract of purchase.

The particular terms of guarantee and duration of guarantee of the unit in question can be taken from the contract documents as well as from the order confirmation.

Warranty claims and liability are excluded in case of one of the following situations:

- Use of the unit in an unintended way
- Inaccurate installation, putting into service, operation, repair or maintenance of the product by people that are not fully authorized
- Use of the product despite of defect, wrongly implemented or non-functional safety devices or protective gear
- Unauthorized or forbidden modifications by the user concerning the electrical equipment of the unit
- Unauthorized or forbidden modifications by the user concerning the mechanical structure of the unit
- Unauthorized or forbidden modifications by the user concerning the operating parameters
- Use of unauthorized tools
- Use of unauthorized operating supplies
- Exceedance of mandatory maintenance intervals
- Cases of disaster caused by foreign matter influence or act of nature beyond control

PLEASE NOTE

Any form of unintended use of the unit and any structural change caused by the user without prior authorization in written form by LAIRD will lead to the termination of warranty as well the termination of the declaration of conformation and will free LAIRD from product liability. This concern includes safety devices as well.

In case of authorized changes or when adding optional equipment it is the sole responsibility of the customer to assure the accurate implementation of the safety devices required.

1.2 Contact Information

If you have questions with respect to this unit please use the contact information given below. Always communicate the following:

- Your name and address
- Name of contact at your address
- Product data as on identification plate: Type of unit, serial number and year of manufacture

Company contact:

Mail: Laird Technologies GmbH
Borsigstrasse 1
D-24568 Kaltenkirchen
Deutschland

Internet: <http://www.lairdtech.com>

E-Mail: info-lcs@lairdtech.com

Phone: +49 4191 9993-0

Fax: +49 4191 9993-33

2 Product Identification

2.1 Unit Specifications

Manufacturer	Laird Technologies GmbH
Type of product	Oil-air cooler
Type of unit	OL 4503
Article number	1264.00

Table 1: Unit specifications

2.2 Identification Plate

The identification plate is attached on the top of the coolant container below the unit cover.

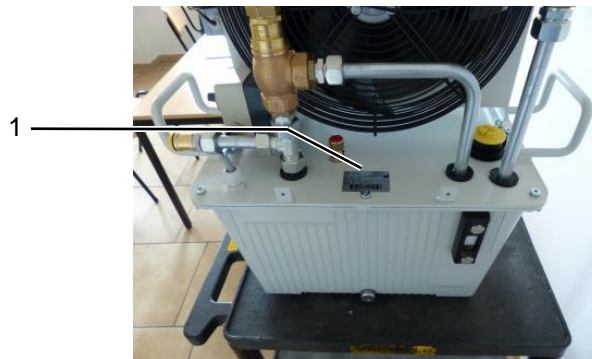

Fig. 1: Position of identification plate

1	Identification plate
---	----------------------



Fig. 2: Unit specific identification plate

1	Unit type	2	Article number
3	Serial number	4	Electrical specification
5	Date of manufacture		

3 Safety Regulations

3.1 Hazard classes

In this document safety instructions are using standardized representation and symbols. Depending on the probability of their incidence and the severeness of consequences three hazard classes are used.



DANGER

**Reference to direct danger for humans.
Inobservance will lead to irreversible injuries or exitus.**



CAUTION

**Reference to noticeable danger for humans or possible damage to property.
Inobservance may lead to reversible injuries or to damage to property.**

3.2 Safety Symbols

In this Operation Manual concrete safety instructions are given in order to point out unpreventable residual risks when operating the unit. These risks include danger for

- Human beings
- The unit and other equipment
- The environment

The safety symbols used in this manual are indicated below. The main reason for their use is to point the reader to the safety instruction given in the text field beside.



Symbol	Meaning
	Warning with respect to general danger or damage to property
	Warning with respect to electrical hazard

Table 2: Warning signs



Symbol	Meaning
	This symbol indicates the requirement of wearing safety gloves
	This symbol indicates the requirement of disconnecting from mains.

Table 3: Signs giving orders

3.3 Hints for Safe Operation

PLEASE NOTE

Conduct inspections on a regular time base

This will ensure that the appropriate measures will be carried out indeed.

The unit is operation save. It was built according to the state-of-the-art.

Despite this the unit could cause hazards if it

- is used in a way it was not intended for
- is used improperly
- is operated under unsuitable conditions

3.3.1 Prevent Hazards

Hazards can be prevented by safety-conscious and anticipatory behaviour of staff.

Everybody working with the unit should keep the following in mind:

- Make this Operation Manual available for everybody at the operation site of the unit in a complete and perfectly readable state!
- Use the unit exclusively for what it was intended!
- The unit must be operational and errorfree. Check the condition of the unit before working with it and within a regular time frame.
- Make sure that nobody can injure himself by any part of the unit!
- Any disruption or recognizable change concerning the unit should be reported to the responsible person.
- Stick to accident prevention regulations as well as any regional regulations!

3.3.2 Hints Regarding the Electrical Equipment



DANGER



Danger to life through electrical shock when working on the electrical equipment of the unit!

- Switch off the unit before starting your work!
- Disconnect the unit from mains by pulling the mains plug!
- Verify that the installation is dead (volt-free)!
- Carry out earthing or short circuiting!

When working on electrical installations the following principles should be observed:

- Works on the electrical installations may only be accomplished by qualified electrical staff!
- When connecting electrical equipment to mains regional regulations have to be observed. Be aware of the wiring diagram information.
- The unit is powered by electricity. Electrical shock hazard exists, if the electrical installations are defective or the insulation fails during operation.
- When switched-off the unit is not disconnected from mains. This is only the case when the mains plug is pulled.
- Any changes regarding the control elements of the unit can have an influence on the safe operation. All intended changes must be authorized by the manufacturer.
- After the implementation of a change the operativeness of the safeguards must be verified.

- No unauthorized changes on the unit are allowed. All intended changes must be authorized by the manufacturer.

3.3.3 Environmental Issues

Environmentally conscious and anticipatory behaviour of staff avoids environmentally hazardous impacts.

The following principles apply for environmentally conscious behaviour:

- Environmentally hazardous substances must not get into the soil or into the drains. They should be kept in appropriate containers.
- Environmentally hazardous substances must be brought to utilization or disposal according to regional regulations.

When dealing with working fluids always keep aware of the safety data sheet of the corresponding manufacturer.

3.3.4 Protective Clothing

When doing a job that leads to contact of the skin with the coolant (e.g. filling-up of the coolant container):

	Wear safety gloves made of PVC, neoprene or nitrile rubber
---	--

3.4 Safety Equipment

PLEASE NOTE

The safety equipment listed below must be integrated in the local control environment by the customer, unless otherwise noted. These tasks must be carried out solely by trained experts. All information required can be taken from the wiring diagram shown in the addendum.

Safety equipment must not be modified, removed or taken out of operation. All parts of the safety equipment must be accessible at all times.

3.4.1 Safety and Signalling Equipment included in the Unit

The unit is equipped with safety equipment at critical spots:

- The filling level of the coolant container is indicated in an inspection glass.
- The circulated oil amount is controlled by a flow control device (flow switch) that must be integrated in the potential-free safety circuit of the device that is to be cooled.
- The oil temperature is controlled by a thermostat. When the oil temperature exceeds the maximum setpoint this is indicated by the potential-free safety circuit.
- The maximum pump pressure is limited by an angle-type safety valve that bypasses the oil stream when the pressure pre-set is exceeded.

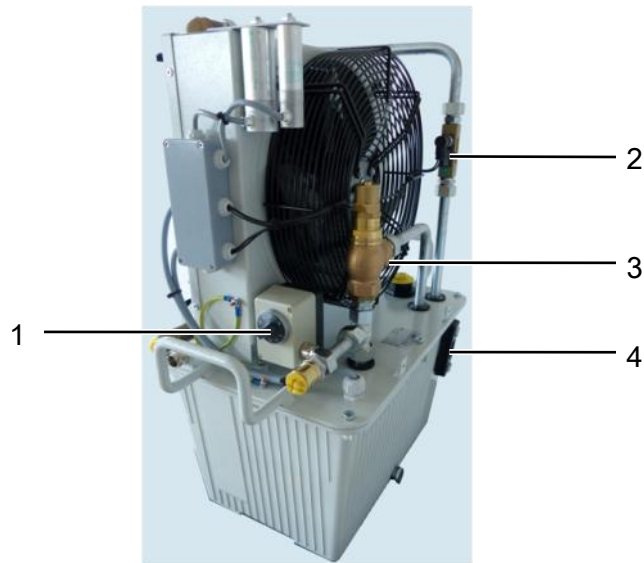

Fig. 3: Safety equipment

1	Thermostat	2	Flow control device (flow switch)
3	Angle-type safety valve	4	Inspection glass, level indicator

3.4.2 Guards

Direct access to hazardous parts or areas of the unit is restricted by the unit cover. The cover may only be removed for the purpose of maintenance or repair works and shall be replaced prior to taking the unit back to operation. The cover is fixed by four screws which can be unscrewed using a metric AF10 wrench.

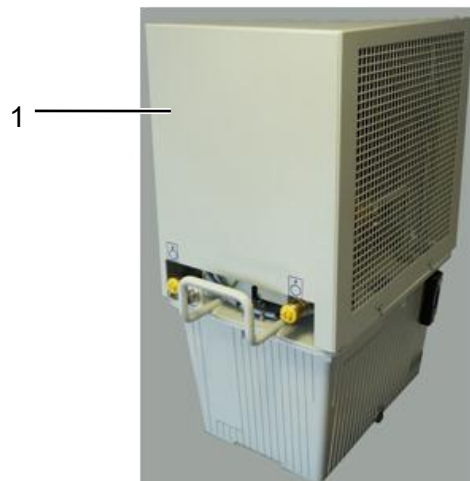

Fig. 4: Guard

1	Unit cover
---	------------

3.4.3 Caution Label

Danger spots on the unit are indicated corresponding to German safety regulation BGV A8 "Sicherheits- und Gesundheitsschutzkennzeichnung am Arbeitsplatz"

Caution labels on the unit must be easily readable at all times. Illegible caution labels must be exchanged without delay.

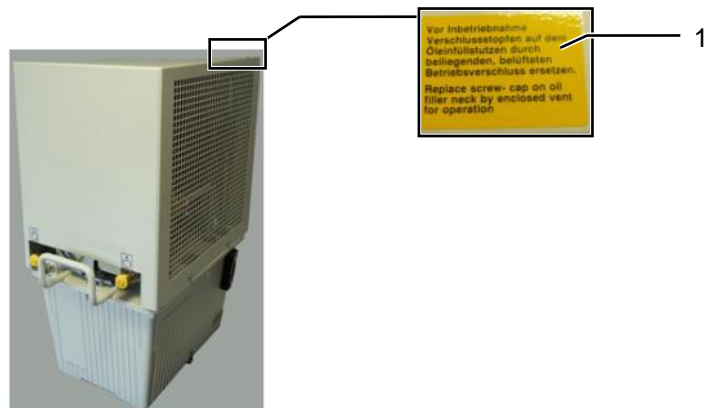

Fig. 5: Caution labels on the unit

1	Hint for using the correct cap on oil filler
---	--

3.5 In Case of Accidents

Should you or an other person be injured when working with the unit:

- Stay calm!
- Give first aid!
- Call the company's first-aider without exception!

First aid at accidents with oil

The unit employs oil as a coolant in a closed-loop configuration. In case of damage oil can leak from the circuit and cause hazards.

- Long term or repeated contact with skin without appropriate cleaning may obstruct the skin pores and may lead to irregularities as oil acne or folliculitis.

When exposed to oil always observe the safety data sheet of the manufacturer.

4 Product Description

4.1 Intended Use

The oil-air cooler OL 4503 is used for the cooling of an oil circuit. Oil circulates between the cooling unit and the device to be cooled. The oil is recooled by an air-cooled heat exchanger. The maximum cooling capacity depends on the ambient air temperature (see page 16).

The unit is exclusively intended for use in industrial and commercial environments.

The intended use also includes the observance and following of all hints given in this Operation Manual.

4.2 Non-Conformity with the Intended Use

Operation of the unit under improper operational conditions is not permitted, since otherwise the operation safety can not be granted.

When using the unit in a way not compliant with the intended use, hazardous situations may occur.

Operation of the unit is not permitted under the following conditions:

- The unit is used for a purpose other than the one it is intended for.
- The unit or parts of it are damaged, the electrical installation is not correct or the insulation is broken.
- Protective or safety equipment is not functional or defect, improperly installed or missing.
- The unit is not working properly.
- The unit was modified without authorization or modified in a way that is not permitted.
- Controlling devices were modified in a way that is not permitted.
- Operational parameters were changed in a way that is not permitted.
- Operation in areas exposed to explosion hazards.
- Operation with cooling media not according to specification.
- Use of unauthorized tools.
- Exceedance of the compulsory maintenance intervals.

PLEASE NOTE

The manufacturer is not liable for damage occurring when using the unit in a way it was not intended. When using the unit in a way it was not intended for, the manufacturer's warranty given by LAIRD will expire.

4.3 Unit Components

Additional information can be retrieved from the flow scheme shown in the addendum. The unit consists of the following main components:

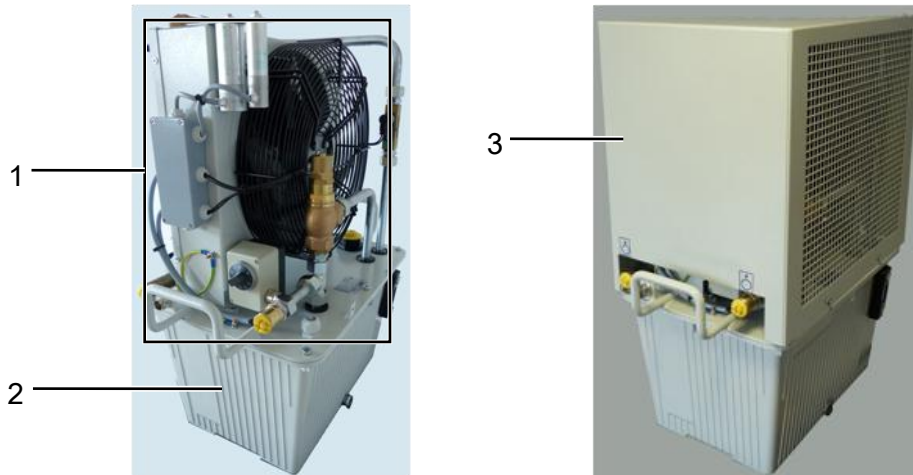

Fig. 6: Main components

1	Cooling circuit	2	Coolant container
3	Sheet-metal hood		

Cooling Circuit

In the cooling circuit the coolant (i.e. the oil) is driven by the pump to the device that is to be cooled and back via the return flow. The heat is dissipated into the ambient air by an air-cooled heat exchanger. Exceedance of the maximum pump pressure is prevented by a bypass circuit. The oil temperature is controlled by an electronic thermostat. Oil throughput is controlled by a flow control device.

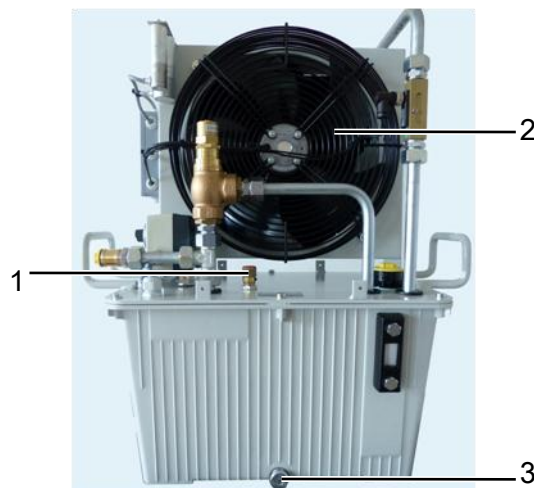

Fig. 7: Main components

1	Stop valve	2	Fan
3	Oil drain screw		

4.4 Specifications

Dimensions and weight

Length:	650 mm
Width:	350 mm
Height:	750 mm
Weight:	49.6 kg (empty)
Coolant capacity:	23 liters (Shell Diala S3-ZXIG)

Table 4: Dimensions and weight

Performance data

Cooling capacity:	4500 Watts at 22.8 K difference between the oil outlet temperature and the ambient air temperature
Pump capacity:	> 22 lpm at 3.5 bar
Mains voltage:	230 VAC \pm 10% 50/60 Hz
Power input:	785 Watts (P_{max} : 230 V; 50 Hz) 1058 Watts (P_{max} : 230 V; 60 Hz)

Table 5: Performance data

Environmental conditions

Operating temperature:	-10°C ... +40°C
Storage temperature:	-25°C ... +70°C
Relative humidity:	20% ... 90%

Table 6: Environmental conditions

Settings

Flow control device	14.0 \pm 0.3 lpm
Thermostat	55 \pm 3 °C
Maximum pressure	9.0 +0.5/-0.2 bar

Table 7: Settings

4.5 Setting-up Requirements

4.5.1 Installation Location

- The location must be even.
- When choosing the installation location the following must be kept in mind: the flow of the cooling air must not be restricted, forward and back flow connections must be easily accessible and all hoses must be installed without sharp bends.

4.5.2 Environmental Conditions



CAUTION

Risk of damage through unsuitable environmental conditions!

Damage to the unit and corrosion damage may result and are not covered by manufacturer's liability.

- The unit is only authorized for use in indoor environments.
- The unit must not be stored or operated in aggressive, humid environments.
- The unit must not be stored or operated outdoor.

Pay attention to the environmental conditions as given in the specifications on page 16.

4.5.3 Infrastructure

The following infrastructure is required for connecting the unit:

Parameter	Rated value
Operating voltage	230 VAC

Table 8: Required infrastructure

5 Transport

5.1 Safety Indications for Transport and Setting-up

 **CAUTION****Risk of injury by lifting the unit!**

The weight of the unit is more than 50 kg.

- Do not lift the unit manually.
- Always use proper auxiliary means such as a forklift or a jack lift.

 **CAUTION****Risk of damage by improper transportation!**

- Transport the unit in upright position.
- Do not tilt the unit or expose it to impacts.

5.2 Transportation of the unit

The unit is delivered shrunk in foil on a transportable pallet. Leave the unit on the pallet until bringing it into service. Use a forklift or jacklift for transportation to the installation location.

5.3 Unpacking

Remove the foil before setting up the unit.

Inspect the unit with regard to:

- Damage caused by transportation
- Completeness of delivery

Lift the unit with a forklift or jack lift off the transportable pallet.

Dispose of the packaging material in accordance with regional regulations

PLEASE NOTE

LAIRD advises to keep the transportable pallet for later transportation of the unit.

6 Initial Operation

6.1 Safety Indications Related to Initial Operation

CAUTION

Danger of malfunction caused by faulty connections during initial operation!

Before switching on the unit make sure that:

- All safety equipment of the unit is implemented and functional.
- All connections were properly made.
- Nobody is endangered by the start-up of the unit.

Please follow the rules in chapter Safety Regulations on page 9.

6.2 Setting to Work

6.2.1 Placement

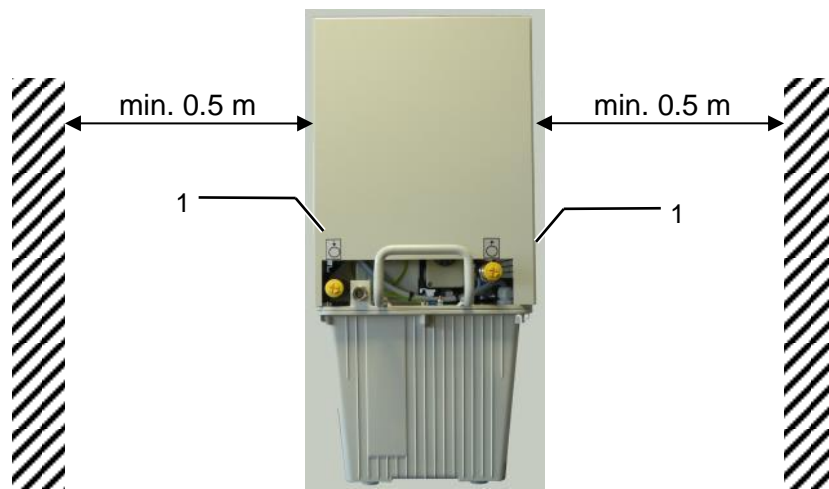

Fig. 8: Minimum clearance for air entrance and air exit

1	Ventilation grid
---	------------------

- 1) Move the unit to its installation location as mentioned in chapter 5.2
- 2) Place the unit in a way that air entrance and air exit are not obstructed. Wall clearance must not be less than 0.5 m, otherwise cooling capacity may be restricted

PLEASE NOTE

In case of storage of the unit at temperatures lower than 5°C or higher than 40°C for longer periods please wait 3 hours prior to initial operation to allow for temperature adjustment.

6.2.2 Cooling Circuit Connection and Filling

CAUTION

Risk of damage by using improper cooling hoses!

This may lead to damage to persons, damage to the unit or corrosion damage.

- When choosing cooling hoses pay attention to sufficient burst strength and compatibility with coolant.
- Only use cooling hoses without any signs of damage.

The cooling hoses are connected to the unit by means of screwed hose nipples.
Oil inlet and oil outlet are indicated with respective symbols.

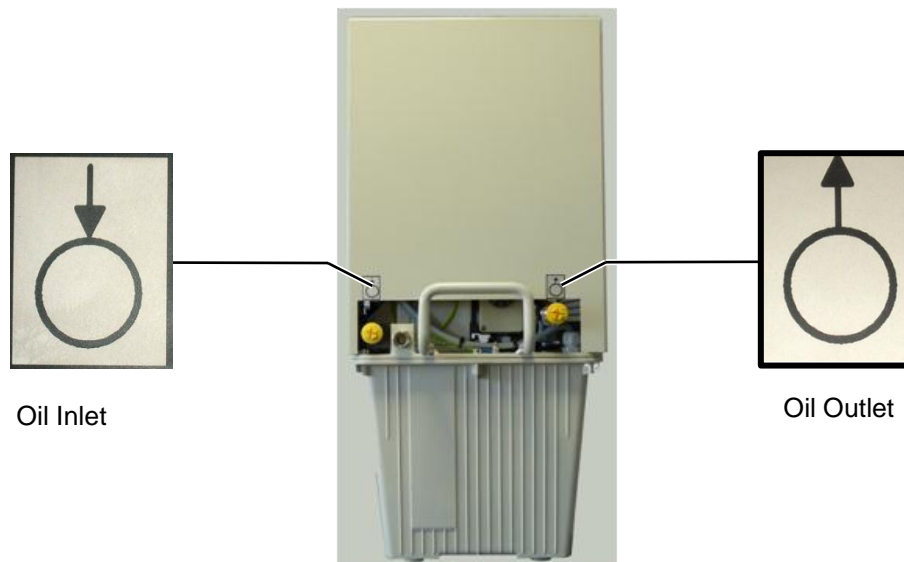

Fig. 9: Labelling of oil inlet and oil outlet

PLEASE NOTE

When operating the unit make sure only to use the operation coolant container cap. This cap allows for pressure equilibrium in the cooling system (breathing). Save the transportation cap for later transportation purposes (e.g. when sending the unit back for repair).

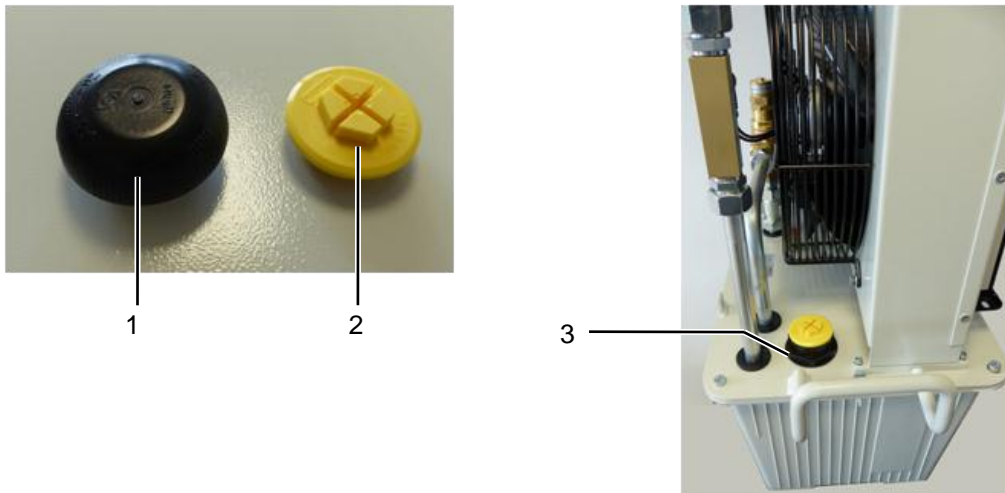

Fig. 10: Operation cap, transportation cap, filler plug of coolant container

1	Operation cap	2	Transportation cap
3	Filler plug of coolant container		

- 1) Unscrew the four screws of the unit cover using a metric AF10 wrench and remove the cover.
- 2) Remove the caps from the hose nipples of oil inlet and oil outlet.
- 3) Connect a hose to the hose nipples for oil inlet and oil outlet and secure it with a hose clamp, respectively.
- 4) Connect the hoses to the corresponding nipples of the device to be cooled.

PLEASE NOTE

When connecting the cooling hoses pay attention to flow direction. Follow the documentation released by the manufacturer of the device to be cooled.

- 5) Remove the transportation cap on the coolant container using an appropriate wrench.
- 6) Fill the coolant container with oil up to a filling level indicated roughly in the center of the inspection glass.
Use a funnel in order not to moisten any current-carrying components with oil
- 7) Close the coolant container using the operation cap supplied on delivery.

6.2.3 Electrical Connections



DANGER

Danger to life by electrical shock when working on the electrical equipment of the unit!



- Switch off the unit before starting your work!
- Disconnect the unit from mains by pulling the mains plug!
- Verify that the installation is dead (volt-free)!
- Carry out earthing or short-circuiting!



CAUTION

Risk of damage through improper connections!

Improper integration of the unit into the safety circuit of the device to be cooled will lead to the inoperativeness of the safety equipment listed in chapter 3.4.

- All required connections must be incorporated according to the wiring diagram shown in the addendum.
- Ensure that all connected safety equipment is properly functioning!
- All tasks should be carried out only by expert staff.

PLEASE NOTE

The unit is delivered without a mains cable. The electrical connection as well as the integration into the safety circuit of the device to be cooled are the customer's responsibility and must be accomplished by expert staff.

Information required can be taken from the specifications listed on page 16 and the wiring diagram available in the addendum.

After implementing the mains cable connect the unit to mains by inserting the mains plug.

6.2.4 Carrying out Setting-to-Work

CAUTION

Lack of coolant may destroy the pump!

- Operate the unit only when the filling level of the coolant container is correct!
- Check the filling level of the coolant container regularly!

After connecting the cooling circuit, filling the coolant container and finishing the electrical connection follow the steps below for the setting-to-work of the unit:

- 1) Open the stop valve.
- 2) Let the unit run for about 1 minute in order to de-aerate the pump.
- 3) Switch off the unit.
- 4) Close the stop valve.
- 5) Let the unit run for about 10 minutes in order to fill and de-aerate the cooling circuit.
- 6) Switch off the unit.
- 7) Check the filling level using the inspection glass. Fill up oil, if required, until a liquid level in the center of the inspection glass. Use a funnel in order not to moisten any current-carrying components with oil.
- 8) Remount the unit cover.

DANGER

Danger to life by electrical shock caused by improperly mounted grounding washer!

- Mount the grounding washer at the position of one of the four screws securing the unit cover!
- Make sure that the screws are properly tightened!



This is to make sure that the grounding washer cannot get loose by vibrations during operation which could lead to the situation of the unit cover carrying current.

- 9) Switch on the unit again and check the compliance with the operational parameters.
- ⇒ The unit is ready for use.

6.3 Daily Start-up

Switch on the unit about 1 minute prior to using the equipment that is to be cooled.

6.4 Setting-to-Work after Storage

Setting-to-work after storage will have to follow the same procedures as required for initial operation (see chapter 6.2).

7 Controlling the Unit

The unit is controlled by using the controls of the equipment that is to be cooled.

All alarm and error signalling is only indicated on the control panel of the equipment that is to be cooled.

7.1 Safety Indications for Controlling the Unit



CAUTION

Lack of coolant may destroy the pump!

- Operate the unit only when the oil filling indication on the coolant container is correct!
- Check the oil filling indication regularly!

Also pay attention to the hints given in the chapter Safety indications on page 9.

7.2 Switching on the Unit

- The unit is ready for switching on.
 - 1) Switch on the unit about 1 minute prior to operation of the device to be cooled using the appropriate control of that device.
 - 2) Check the compliance with the required operational data according to the specifications listed on page 16.
- ⇒ The unit is running.

7.3 Switching off the Unit

- 1) Switch off the unit using the control of the device to be cooled.
 - 2) Close all valves that may exist along the hoses running to and from the unit
- ⇒ The unit is out of operation.

7.4 Settings

The angle-type safety valve and the thermostat are set to the specified values by the manufacturer. Should any modification be required, please follow the steps indicated below.

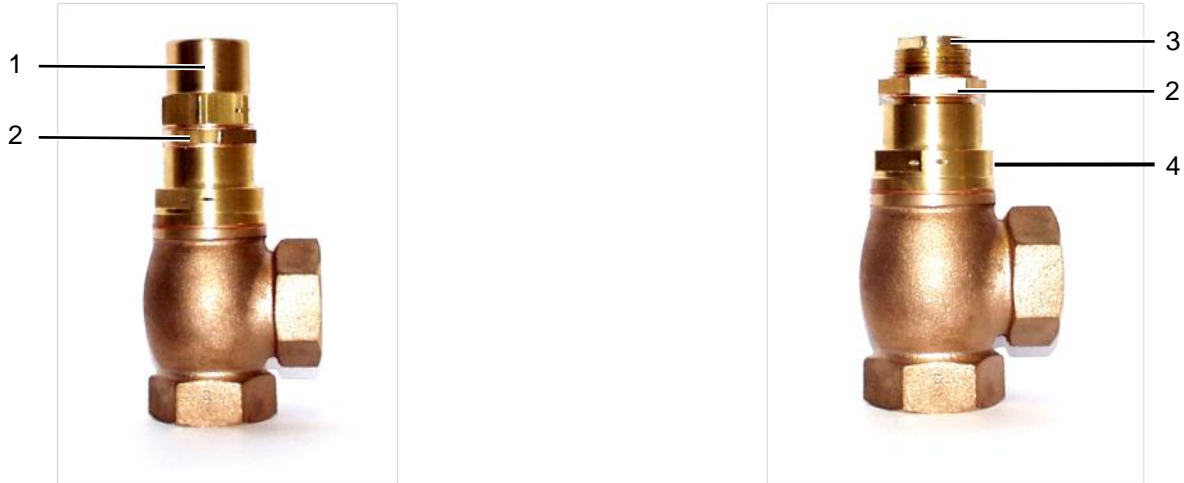

Fig. 11: Angle-type safety valve

1	Cover nut	2	Counter nut
3	Adjusting screw	4	Wrench to be used here for fixation

7.4.1 Pressure Setting on the Angle-type Safety Valve

PLEASE NOTE

A small amount of oil may leak from the valve.

- The unit is switched off.
- 1) Loosen cover nut using a metric AF36 wrench and dismount. Use second wrench of the same size at point 4 in Fig. 10 for holding the valve in place.
- 2) Loosen counter nut by turning it anticlockwise (use a AF36 wrench).
- 3) Set adjusting screw to the pressure value required:
 - Screwing in will increase the pressure setpoint.
 - Screwing out will decrease the pressure setpoint.
- 4) Tighten counter nut by turning it clockwise.
- 5) Re-install cover nut and tighten.
 - ⇒ Pressure setting is accomplished.
- 6) Operate unit and check pressure.
 - ⇒ If the intended pressure value is not yet reached, repeat the whole procedure.

7.4.2 Setting the Thermostat

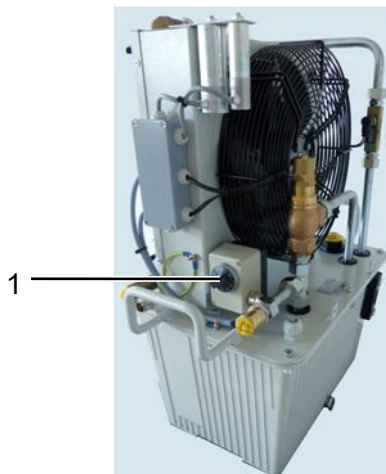

Fig. 12: Thermostat

1	Knob of thermostat
---	--------------------

Increase the temperature setpoint

- 1) Turn the knob clockwise.
- ⇒ The switch-off temperature is set to a higher value.

Decrease the temperature setpoint

- 1) Turn the knob counter-clockwise.
- ⇒ The switch-off temperature is set to a lower value.

8 Disruptions

8.1 Disrupt Operation

The most common reason for disrupt operation of the unit is improper maintenance. Maintenance should be carried out regularly according to the maintenance intervals defined in chapter 9.

In case of disruption start with checking the following:

- fan polluted or blocked?
- coolant polluted?
- Low coolant contents because of leakage, evaporation or an extended cooling circuit with long hoses?

More help can be found in the following paragraph.

In case you do not succeed in identifying the problem cause by means of this manual please contact the service department of LAIRD.

8.1.1 Trouble Shooting

For trouble shooting you may rely on the following:

- Alarm and error signalling within the safety circuit of the device to be cooled
- Wiring diagram
- Flow scheme
- Trouble shooting table (see below)

Problem	Possible reason	Countermeasure
The unit does not start	Mains cable plugged in?	Insert mains plug→ page 22
The unit is running, but cooling capacity is not available or too low	External hoses sharply bent?	Pay attention to smooth bends when hoses are connected
	Unit properly located?	Clearance to walls not less than 0.5 m → page 19
	Coolant hoses connected?	Connect hoses considering flow direction→ page 20
	Is there flow in cooling circuit?	Flow is signalled potential-free by the safety equipment of the unit and can be visualized in the range of controls of the device to be cooled.
	Fan turning?	Cover the ventilation grid next to the fan with a sheet of paper. If the paper is sucked and hold by the air flow, the fan works properly
	Ambient temperature too high?	Check specifications →page 16
Noisy unit	Contents in coolant container low.	Refill coolant

Table 9: Trouble shooting list

9 Maintenance and Cleaning

Diligent maintenance is the prime factor for assuring an error-free and efficient operation of the unit. Operating personnel can perform these tasks when properly trained.

9.1 Maintenance Schedule

Device	Activityt	Interval	Criteria	Tools	Performer
Heat Exchanger	Clean	Minimum weekly (if required, daily)	Plate fins and ventilation grids not polluted	AF10 wrench, compressed-air, vaccum cleaner	Operating personnel
Coolant container	Check filling	Weekly	Coolant indication in the center of inspection glass	Funnel, measuring cup	Operating personnel
Coolant quality	Inspect visually	Weekly	Absence of cloudiness or floating particles	Inspection glass on coolant container	Operating personnel

Table 10: Maintenance schedule

9.2 Cleaning of Heat Exchanger

Cooling capacity is reduced to a large extend, if the heat exchanger is polluted. The heat exchanger must be checked for pollution regularly and be cleaned, if required.

For cleaning the heat exchanger follow these steps:

- 1) Switch off the unit.
- 2) Unscrew the four screws holding the unit cover with a AF10 wrench and remove the cover.
- 3) Clean the heat exchanger using compressed air opposite to the direction of air entrance into the unit (i.e. from the inside out).
- 4) Remove any pollution from the ventilation grids using a vacuum cleaner.
- 5) Remount the unit cover.

⇒ The unit is ready for operation.

9.3 Refilling of Coolant

Since the cooling circuit is an open circuit, evaporation of coolant may occur. Thus the filling level of the coolant container has to be checked regularly, and coolant might have to be refilled as described in chapter 6.2.2 on page 20.

9.4 Cleaning of Unit Casing



CAUTION

Risk of damage due to the use of improper cleansing material!

When using aggressive or abrasive cleaning agents corrosion may occur as result of a damaged paint film.

- For cleaning the device casing only use mild cleaning agents (e.g.dish washing detergents)!
- Use clean and lintless cloth for cleaning!

Regularly remove dirt from the casing of the unit to prevent corrosion damage and clogging of the air grids. Pay attention that all the labels at the unit are always clean and legible.

10 Repair

PLEASE NOTE

Do not carry out any repair work on the unit. Send the unit back to the LAIRD service department (for contact see page 7).

11 Dismounting, Disposal, Storage

11.1 Temporary Placing out of Operation

For placing the unit out of operation for maintenance or repair follow the steps below:

- 1) Switch off the unit.
- 2) Close all valves that may be incorporated in the cooling circuit.
- 3) Disconnect all hoses to and from the unit.
- 4) Place a collection container of sufficient volume (23 liters minimum) close to the drain screw.
- 5) Loosen the drain screw with a 10 mm Allen key and remove it.
- 6) Let the coolant container run empty into the collection container. To empty the coolant container completely the unit must be tilted.

PLEASE NOTE

The coolant has to be collected and disposed of according to applicable regulations.

- 7) Re-attach the drain screw and clean the unit.
- ⇒ The unit is placed out of operation.

11.2 Re-packaging the Unit

In order to prevent spilling of residual coolant from the coolant container during transport the transport cap must be attached.

- The unit has been switched off, emptied (see chapter 11.1) and the unit cover has been removed.
- 1) Remove the operation cap from the coolant container.
 - 2) Attach the transport cap.
 - 3) Remount the unit cover.
 - 4) Put the protection caps on the hose clamps.
 - 5) Lift the unit with a forklift or jacklift and place the transportable pallet under it.
 - 6) Enclose the unit including the transportable pallet with shrinking foil and shrink the foil tight.
- ⇒ The unit is ready for transportation.

11.3 Storing the Unit

The storage area must be even and the unit should not stand on an edge or other obstructive object.

The environmental conditions for storage of the unit or parts of it can be found in the specification paragraph on page 16.

11.4 Disposal

The unit was manufactured mainly from recycable material.

Make sure the components of the unit end up at a qualified company for disposal and recycling.

Contact LAIRD for take back of end-of-life units (see company contact on page 7) or ask a company destined for disposal and recycling.

11.5 Disposal of Operating Materials

The operating materials of the unit can be hazardous to the environment and to health.

Make sure the operating materials are disposed of or recycled according to local regulations.

Also, the safety specifications of the coolant manufacturer must be obeyed.

11.6 Return of the Unit to LAIRD

PLEASE NOTE

Declaration of decontamination

Before re-shipment of the unit a declaration of decontamination must be sent to LAIRD.

12 Wear Parts and Spare Parts

Spare parts must comply with the technical specifications defined by LAIRD. Original LAIRD parts are subject to strict obligations and fulfill these requirements.

LAIRD does not provide warranty service in case of damages caused by the use of spare parts made by manufacturers other than LAIRD.

PLEASE NOTE

Identification data concerning the unit and spare parts

The type of unit and the article number can be found on the identification plate of the unit. The corresponding numbers shown in drawings 12 and 13 as well as the part description are listed in the spare part list (table 11).

Please direct your inquiries and orders to LAIRD (contact see page 7) with the following detailed information:

- Type of unit
- Article number
- Serial number
- Part description
- Quantity
- Shipping details

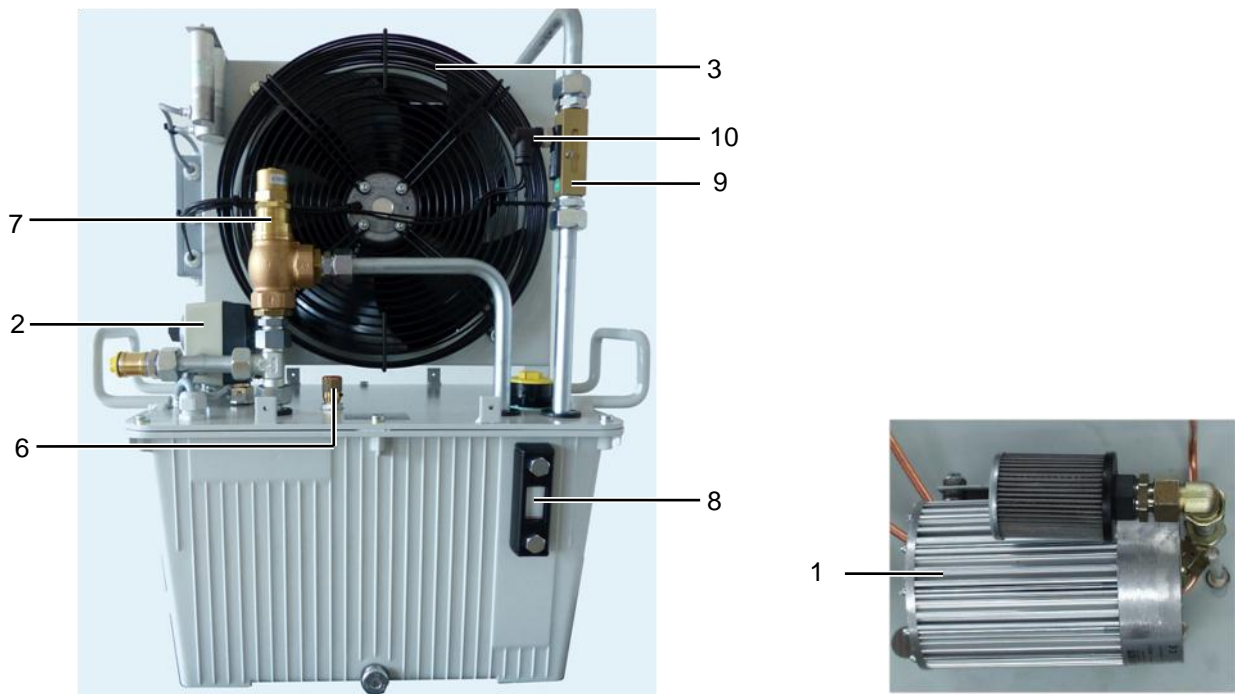

Fig. 13: Spare part overview part 1

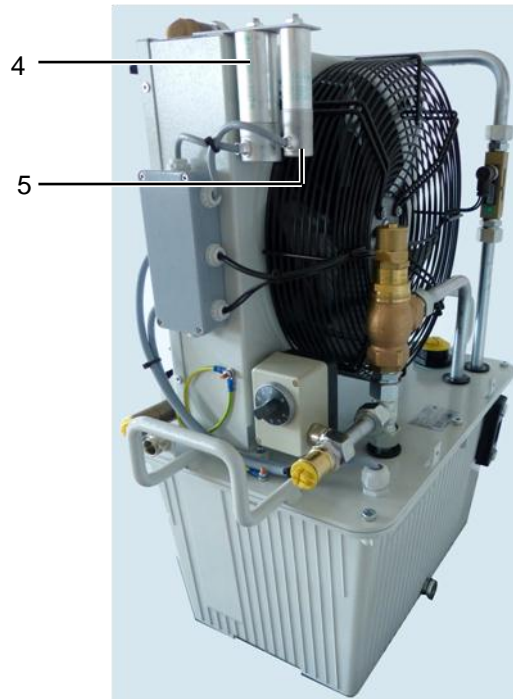

Fig. 14: Spare part overview part 2

Pos.	Qty	Description	Article No.
1	1	Motor pump unit KA1-26-230-2	95205237.00
2	1	Thermostat AMFS-13	95160001.00
3	1	Axial fan S4E 330-AP 18-31	95251655.00
4	1	Starter capacitor for fan	95290709.00
5	1	Starter capacitor for pump	95290735.00
6	1	Stop valve 1/4"	96521001.00
7	1	Angle-type safety valve	96121014.00
8	1	Inspection glass	93300201.00
9	1	Flow switch	95140572.00
10	1	Control head for flow switch	95140567.00

Table 11: Spare parts

Addendum

Performance chart

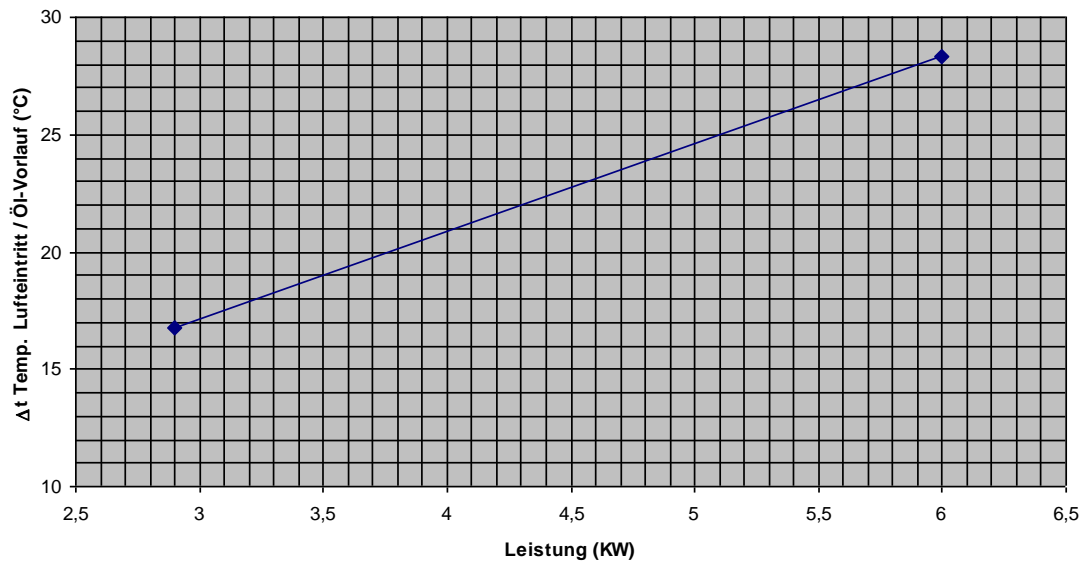

Cooling capacity versus difference between entering air and supplied coolant temperatures

Flow scheme

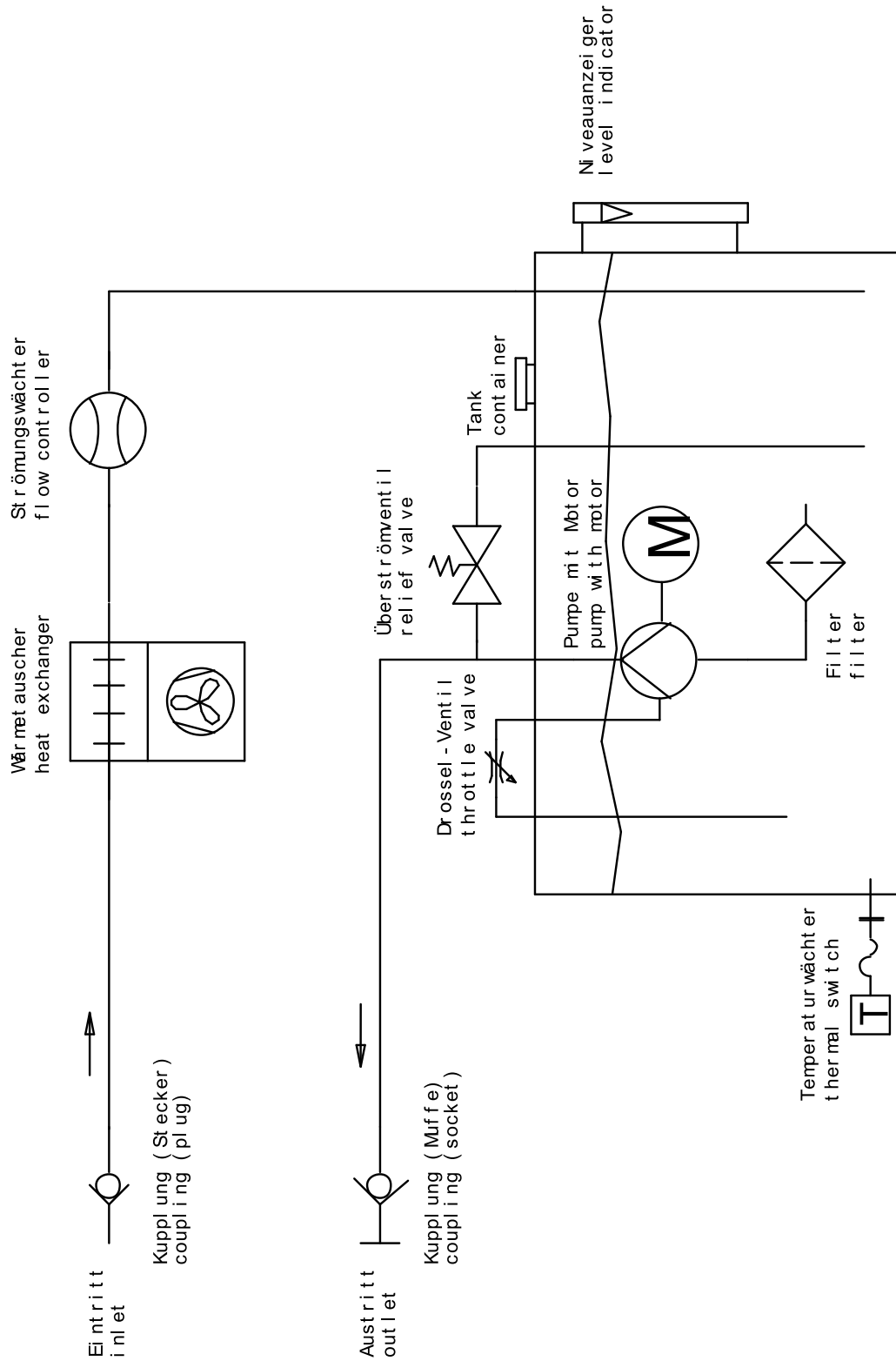

Wiring diagram

