



Doc. No. 文件编号

67400-185-EB

Rev

B

Title 题目

CABLE ASSY AC CON 125V 10A BLACK

Project 产品

7496

Cover Page 首页

Document Category 文件种类

- |  |  |  |   |
|--|--|--|---|
| <input type="checkbox"/> IPS 产品规格            | <input type="checkbox"/> OQCP 成品品质控制程序 | <input type="checkbox"/> BOM 物料名细表     | <input type="checkbox"/> PQP 产品品质计划         |
| <input checked="" type="checkbox"/> DWG 工程图纸 | <input type="checkbox"/> WI 工作指引       | <input type="checkbox"/> PQCP 制程品质控制程序 | <input type="checkbox"/> OP 运作程序            |
| <input type="checkbox"/> IQCP 来料品质控制程序       | <input type="checkbox"/> OTHERS        | <input type="checkbox"/> QA 品质保证       | <input type="checkbox"/> PFMEA 潜在的失效模式及后果分析 |

Revise History 更改记录

Rev 版次	DCN No. 文件更改通知编号	Effective 生效日期	Description 更改摘要
A	-----	11/30/2011	RELEASED PER ECO SZ0760(NEW ISSUE)
B	C-DCN-15-1546 C-ECN-15-0243	04/20/2015 07/13/2015	Updated EU LOGO

Control Document

文件控制

Approved 批核

Signature 签名

Date 日期

Issuer 发布者

Winner (wy)

04/20/2015

Quality 品管部

( )

Production 生产部

( )

PE 产品工程部

徐恩新 (freeman)

04/20/2015

MM 物料管理部

( )

PM 项目管理部

( )

1	2	3	4	5	6	7	8			
PART NUMBER				REV.	ZONE	DESCRIPTION	DATE	BY	CHECK	APPR.
67400-185-EB				A	ALL	RELEASED PER ECO SZ0760(NEW ISSUE)	11/30/2011	---	---	WY
				B	ALL	Updated EU LOGO	04/14/2015	Dora	Winner	Freeman

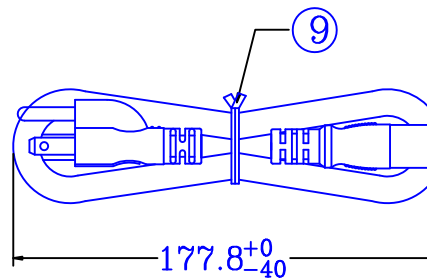
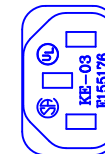
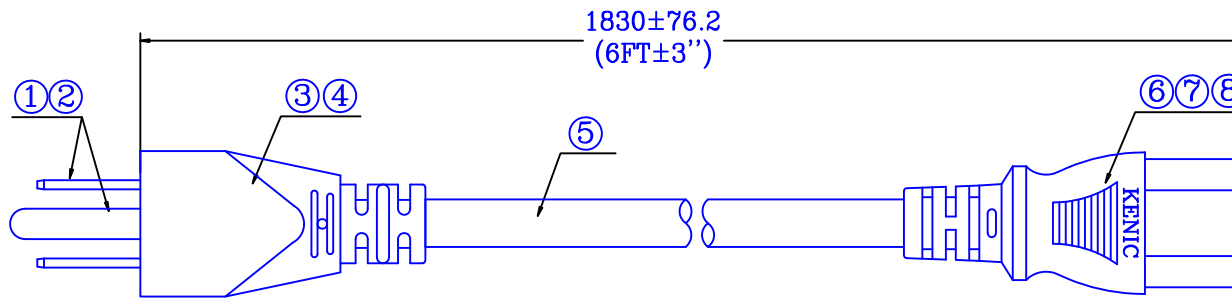
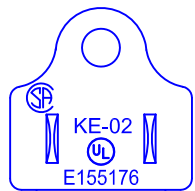

扎线/包装示意图

- NOTE:
- 3. CRITICAL DIMENSIONS WITH MARK "\*\*\*";
  - 2. BLACK COLORED, UL & CSA VW-1 APPROVED (MARKED ON THE CORD).
  - 1. MUST MEET RELATIVE RESTRICTED SUBSTANCE LEVELS OF EU RoHS DIRECTIVE. SPS is based on IEC A/C CABLE

成品单重(参考)	150±15g				
9	扎带	——	PE扎带	1 PC	黑色
8	外模	KPBK00104EX0	KE-03(美规 UL) 注塑外模 PVC	——	黑色
7	内套	KHPPAWT00012	内套	1 SET	——
6	五金	KMA2U0110001	U型磷铜五金	3 PCS	——
5	电线	KWBK00102EX0	SVT 18AWGX3C 60°C BK(压字)	1810±15	黑色
4	外模	KPBK00104EX0	KE-02(美规 UL 10A 125V) 注塑外模 PVC	——	黑色
3	内套	KHPPAWT00015	内套	1 PC	——
2	五金插脚	KMA1T0020201	Ø4.75圆端子	1 PC	——
1	五金插脚	KMA1U0020206	UL非极性铜片	2 PCS	——
序号	名称	物料料号	描述	数量	颜色

PROPRIETARY AND CONFIDENTIAL: THE INFORMATION CONTAINED IN THIS DRAWING IS THE SOLE PROPERTY OF ICCNEXERGY, INC. ANY REPRODUCTION IN PART OR AS A WHOLE WITHOUT WRITTEN PERMISSION OF ICCNEXERGY, INC. IS PROHIBITED.

CAD DRAWING  
DO NOT EDIT

Intelligent Power Solutions

SCALE	NONE	MORE THAN	LESS THAN	TOLERANCE	HOLE DIAMETERS	ALL DIMENSIONS ARE IN MILLIMETERS UNLESS OTHERWISE SPECIFIED TOLERANCE BLOCK(PER ASME Y14.5) ANGULAR ±1/2"(INCLUD DRAFT)
INITIAL DESIGN	DATE	0	5.00	±0.10	0.34-6.35 +0.13 -0.03	
WY	11/30/2011	5.00	63.50	±0.13	6.35-12.70 +0.15 -0.03	
CHECK	DATE	63.50	304.80	±0.002MM/MM	12.70-25.40 +0.25 -0.03	PROJECT- 7496
LG	11/30/2011	SHARP CORNER RADIUS 0.15 ±0.05				PART NO. 67400-185-EB
APPROVAL	DATE	TITLE CABLE ASSY AC CON 125V 10A BLACK				SIZE SHEET NO. 1 OF 3
WD	11/30/2011					A4

PART NUMBER  
67400-185-EB

REV.	ZONE	DESCRIPTION	DATE	BY	CHECK	APPR.
A	ALL	RELEASED PER ECO SZ0760(NEW ISSUE)	11/30/2011	---	---	WY
B	ALL	Updated EU LOGO	04/14/2015	Dora	Winner	Freeman

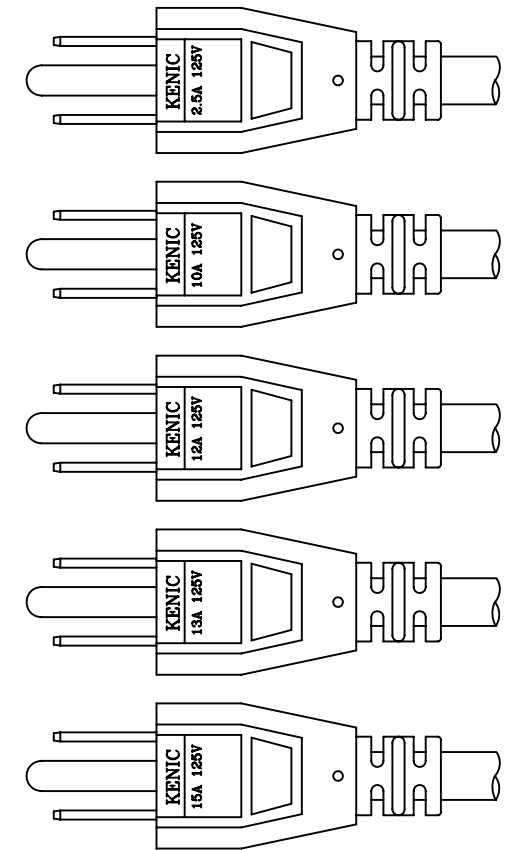
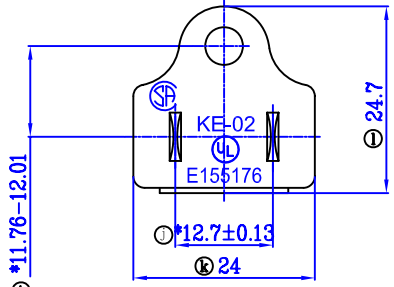
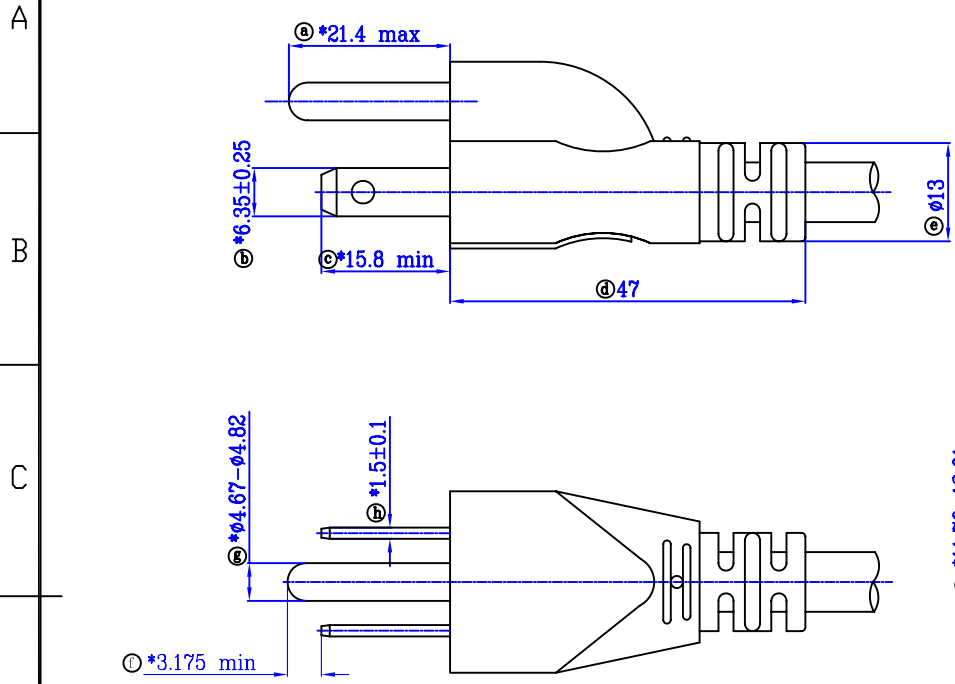

- AVAILABLE WITH CORDS:
- SPT-1,SPT-2,SVT,SVT SHIELDED 18AWGX3C 2.5A 125V + KE-33
  - SPT-1,SPT-2,HPN,SVT,SVT SHIELDED,SJT,SJT SHIELDED 18AWGX3C 10A 125V + KE-03
  - SVT,SVT SHIELDED,SJT 18AWGX3C 10A 125V + KE-07
  - SPT-1,SPT-2,HPN,SVT,SJT 18AWGX3C 10A 125V + KE-24
  - SPT-2,SPT-2W,SPT-3,SVT,SJT,SJTW,SJTO,SJTOW 18AWGX3C 10A 125V + KE-02S
  - SVT 17AWGX3C 12A 125V + KE-24
  - SPT-2,HPN,SJT 16AWGX3C 13A 125V + KE-03
  - SVT,SJT 16AWGX3C 13A 125V + KE-07
  - SPT-2,HPN,SJT 16AWGX3C 13A 125V + KE-24
  - SPT-2,SPT-2W,SPT-3,SVT,SJT,SJTW,SJTO,SJTOW 16AWGX3C 13A 125V + KE-02S
  - SJT 14AWGX3C 15A 125V + KE-03
  - SJT 14AWGX3C 15A 125V + KE-07
  - SJT 14AWGX3C 15A 125V + KE-24
  - SPT-3,SJT,SJTW,SJTO,SJTOW 14AWGX3C 15A 125V + KE-02S
  - HPN 16AWGX3C 15A 125V + KE-120

带 \* 号尺寸为安规尺寸，其它未标注公差为±1.0

CAD DRAWING DO NOT EDIT				 Intelligent Power Solutions			
SCALE	NONE	LINEAR	MORE THAN	LESS THAN	TOLERANCE	HOLE DIAMETERS	ALL DIMENSIONS ARE IN MILLIMETERS UNLESS OTHERWISE SPECIFIED TOLERANCE BLOCK(PER ASME Y14.5) ANGULAR ±1/2"(INCLUD DRAFT)
INITIAL DESIGN	DATE		0	5.00	±0.10	0.34-6.35 +0.13 -0.03	
WY	11/30/2011		5.00	63.50	±0.13	6.35-12.70 +0.15 -0.03	
CHECK	DATE		63.50	304.80	±0.002MM/MM	12.70-25.40 +0.25 -0.03	PROJECT- 7496
LG	11/30/2011		SHARP CORNER RADIUS 0.15 ±0.05				PART NO. 67400-185-EB
APPROVAL	DATE	CABLE ASSY AC CON 125V 10A BLACK				SIZE A4	SHEET NO. 2 OF 3
WD	11/30/2011						

PART NUMBER  
67400-185-EB

REV.	ZONE	DESCRIPTION	DATE	BY	CHECK	APPR.
A	ALL	RELEASED PER ECO SZ0760(NEW ISSUE)	11/30/2011	---	---	WY
B	ALL	Updated EU LOGO	04/14/2015	Dora	Winner	Freeman

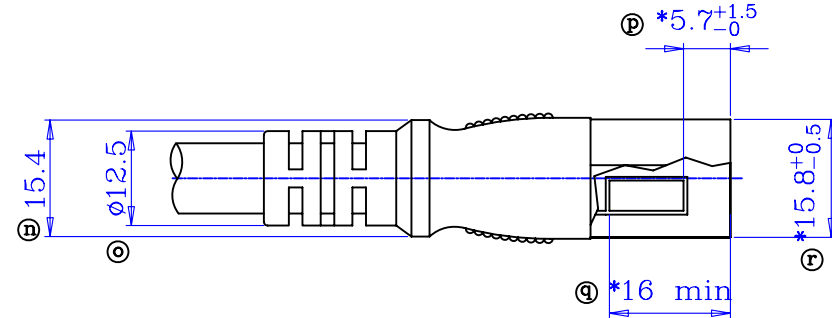
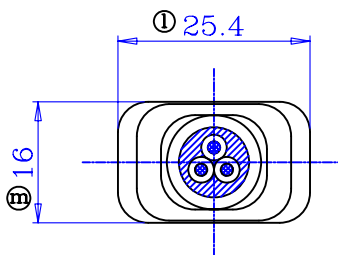
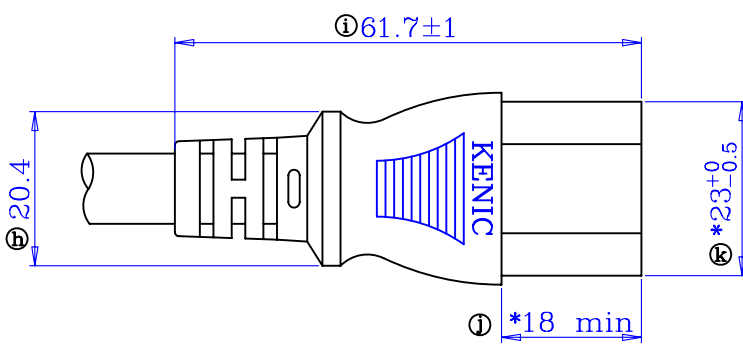
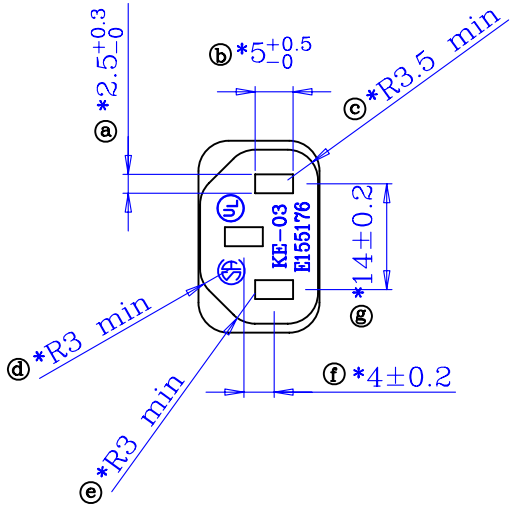

带 \* 号尺寸为安规尺寸，其它未标注公差为±0.5

AVAILABLE WITH CORDS:  
SVT 18AWG x 3C 10A 125V  
SJT 18AWG x 3C 10A 125V  
(SHIELDED & UNSHIELDED)  
SJT 16AWG x 3C 13A 125V  
14AWG x 3C 15A 125V

PROPRIETARY AND CONFIDENTIAL: THE INFORMATION CONTAINED IN THIS DRAWING IS THE SOLE PROPERTY OF ICCNEXERGY, INC. ANY REPRODUCTION IN PART OR AS A WHOLE WITHOUT WRITTEN PERMISSION OF ICCNEXERGY, INC. IS PROHIBITED.

CAD DRAWING  
DO NOT EDIT

Intelligent Power Solutions

SCALE	NONE	MORE THAN	LESS THAN	TOLERANCE	HOLE DIAMETERS	ALL DIMENSIONS ARE IN MILLIMETERS UNLESS OTHERWISE SPECIFIED TOLERANCE BLOCK (PER ASME Y14.5) ANGULAR ±1/2° (INCLUD DRAFT)
INITIAL DESIGN	DATE	0	5.00	±0.10	0.34-6.35 +0.13 -0.03	
WY	11/30/2011	5.00	63.50	±0.13	6.35-12.70 +0.15 -0.03	
CHECK	DATE	63.50	304.80	±0.002MM/MM	12.70-25.40 +0.25 -0.03	PROJECT- 7496
LG	11/30/2011	SHARP CORNER RADIUS 0.15 ±0.05				PART NO. 67400-185-EB
APPROVAL	DATE	TITLE CABLE ASSY AC CON 125V 10A BLACK				SIZE A4
WD	11/30/2011					SHEET NO. 3 OF 3