

## Technical Data Sheet

# Photo-link Light Transmitter Unit

**PLT532**

### Features

- High speed signal transmission ( 50Mbps NRZ Signal )
- TTL interface compatible
- +3~+5V single power source
- Pb Free
- The product itself will remain within RoHS compliant version.

### Descriptions

The opto-electrical component is assembled with a 660nm GaAs RCLED and a driver IC. It transforms the electrical signal to optical signal and be transmitted by 1mm diameter plastic optical fiber.

The component is operated at +3~+5V and has good performance at low dissipation current, steady light output and efficient light coupling.



### Applications

- Digital audio equipment
- CD player
- DVD player
- HDMI Digital (192kHz) Audio Interface
- Below 50Mbps Transfer Signal Market

### Device Selection Guide

Chip		Operating Voltage (Vcc)	Dissipation Current(mA)		Fiber Coupling Light Output (dBm)		
Material	$\lambda$ p(nm)		Typ.	Max.	Min.	Typ.	Max.
GaAs	660	+3.0~5.0	8	10	-21	---	-15

Package Dimension:

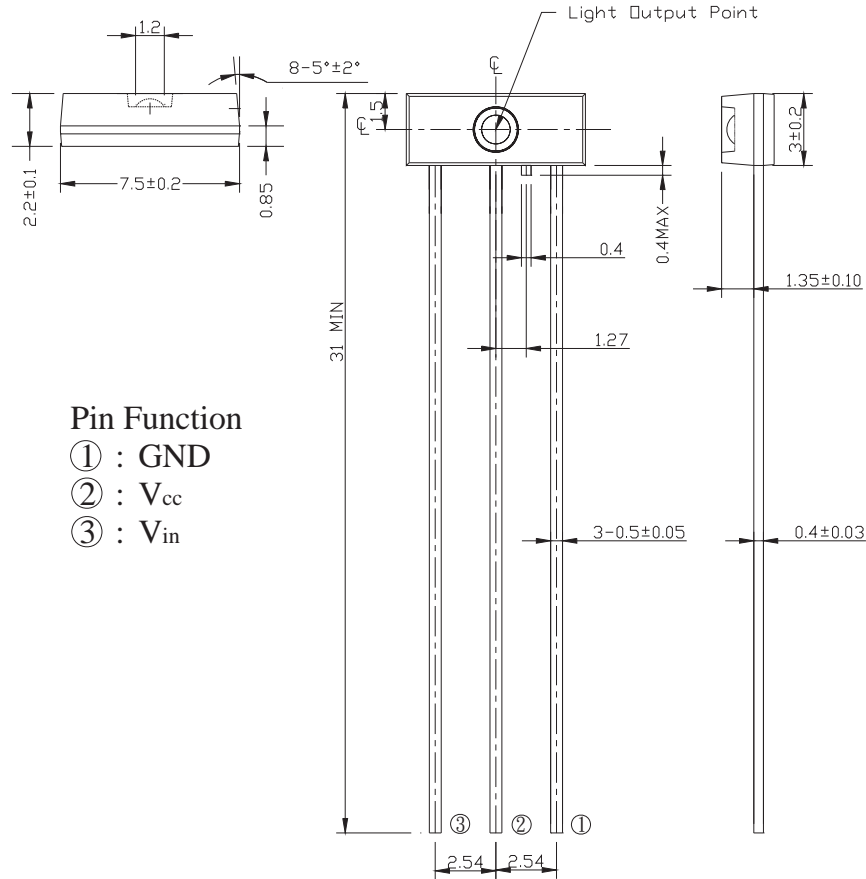

Pin Function

- ① : GND
- ② :  $V_{cc}$
- ③ :  $V_{in}$

- Notes:** 1. All dimensions are in mm.  
 2. General Tolerance: Pin length tolerance is  $\pm 0.50$  mm  
 others are  $\pm 0.10$  mm

**Absolute Maximum Ratings( Ta = 25°C)**

Parameter	Symbol	Rating	Unit
Supply Voltage	Vcc	-0.5 to 7	V
DC Input Voltage	Vin	-0.5 to Vcc+0.5	V
Storage Temperature	Tstg	-40 to 85	°C
Operating Temperature	Topr	-20 to 70	°C
Soldering Temperature	Tsol	260*	°C

\* Soldering time ≤ 10 s.

**Electro-Optical Characteristics**

Parameter	Symbol	Conditions	MIN.	TYP.	MAX.	Unit
Operating Voltage	Vcc	Low Voltage	2.75	3.00	3.25	V
		High Voltage	4.75	5.00	5.25	V
Peak Emission Wavelength	$\lambda_p$		640	660	680	nm
Transmission Rate		NRZ Code	DC	-	50	Mbps
Fiber Coupling Output Power	Pf	*1	-21	-18	-15	dBm
Dissipation Current	Icc	*1	5	-	10	mA
High Level Input Voltage	V <sub>IH</sub>		2	-	-	V
Low Level Input Voltage	V <sub>IL</sub>		-	-	0.8	V
Rise Time	T <sub>r</sub>	50Mbps	-	8	-	ns
Fall Time	T <sub>f</sub>	50Mbps	-	8	-	ns
Low to High Delay Time	t <sub>pLH</sub>	*2	-	-	50	ns
High to Low Delay Time	t <sub>pHL</sub>	*2	-	-	50	ns
Pulse Width Distortion	$\Delta tw$	*2	-5	-	5	ns
Jitter	$\Delta tj$	*2	-	-	5	ns

\*All Plastic Optical Fiber ( 980/1000um )

\*Circuit Layout Notice: When power is off, it must be cut off together in Vin and Vcc pin.  
If it only has Vcc power-off, LED will sure to be no output power.

Vcc	Vin	LED Condition
2.7~5.5V	High	ON
2.7~5.5V	Low	OFF
2.7~5.5V	FLOATING	OFF
FLOATING	0~Vcc	OFF

**Measuring Method**

\*1 Measuring method of optical output coupling fiber and dissipation current

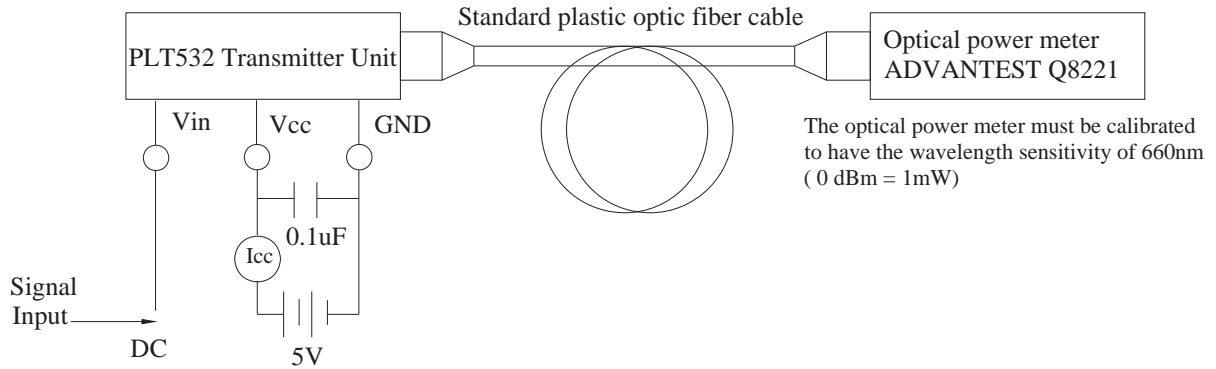

\*2 Pulse response measuring method

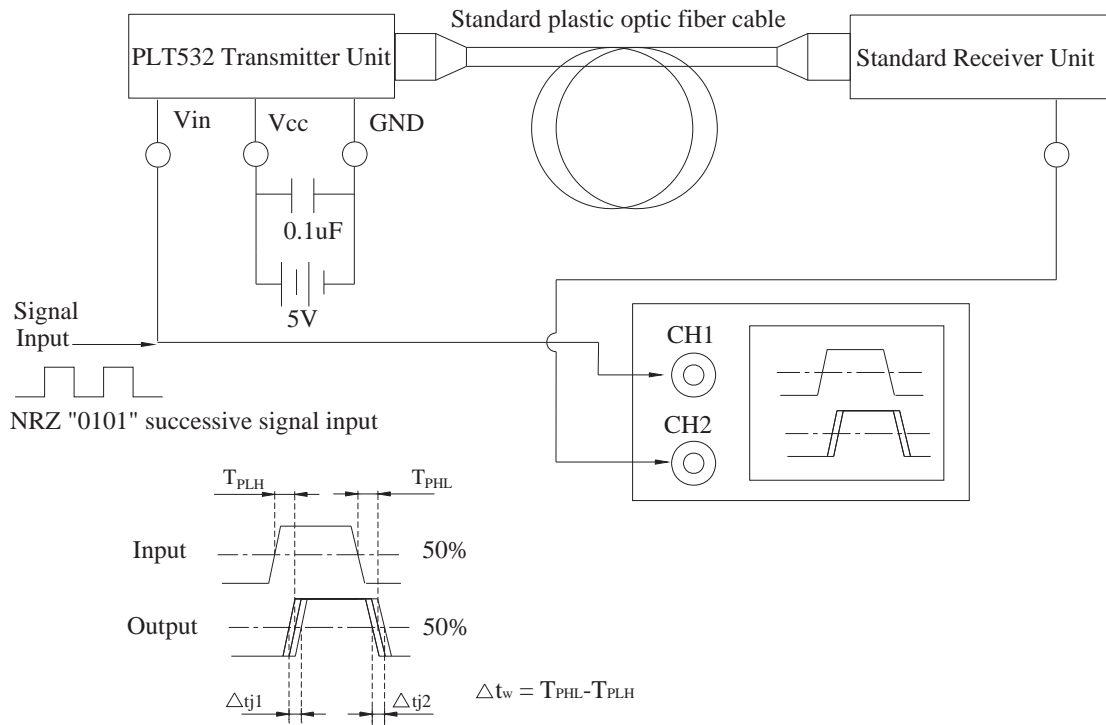

**Typical Electro-Optical Characteristics Curves**

\*Fig.3 Relative Output Power vs. Operating Temperature

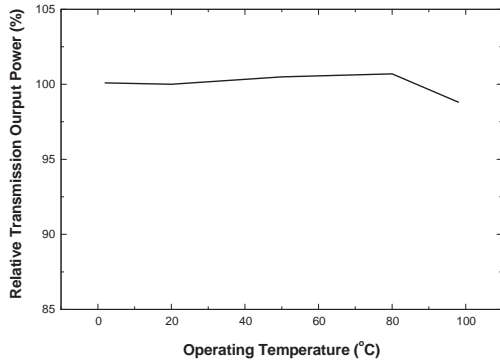

\*Fig.4 Relative Output Power vs. Input Signal

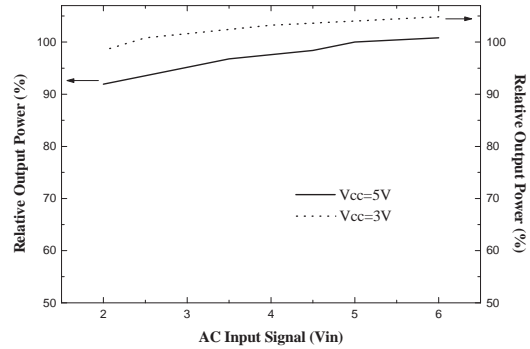

\*Fig.5 Relative Output Power vs. Operating Voltage

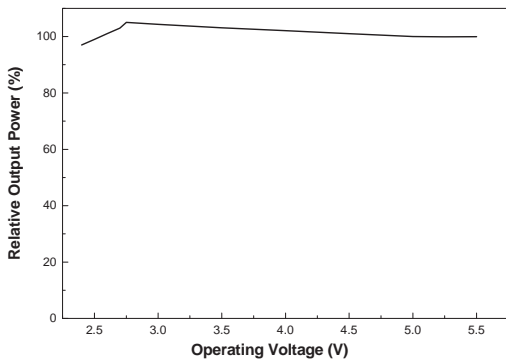

\*Fig.6 Relative Output Power vs. Transfer Rate

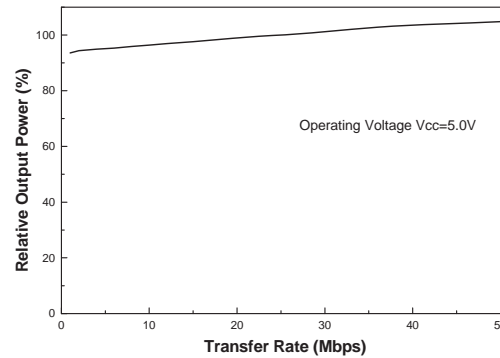

**Packing Quantity Specification**

1. 500 pcs/bag
2. 4 bag/box

**Label Form Specification**

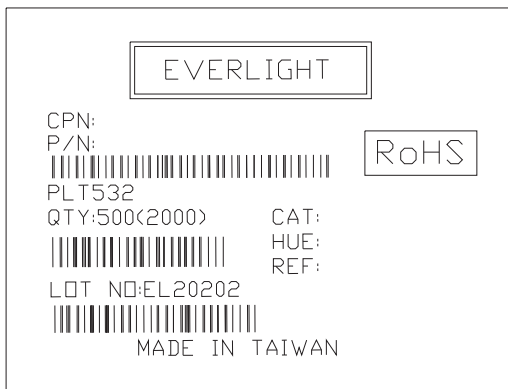

CPN: Customer's Production Number  
P/N : Production Number  
QTY: Packing Quantity  
CAT: Ranks  
HUE: Peak Wavelength  
REF: Reference  
LOT No: Lot Number  
MADE IN TAIWAN: Production Place

**Notes**

1. Above specification may be changed without notice. EVERLIGHT will reserve authority on material change for above specification.
2. When using this product, please observe the absolute maximum ratings and the instructions for using outlined in these specification sheets. EVERLIGHT assumes no responsibility for any damage resulting from use of the product that does not comply with the absolute maximum ratings and the instructions included in these specification sheets.
3. These specification sheets include materials protected under copyright of EVERLIGHT Corporation. Please don't reproduce or cause anyone to reproduce them without EVERLIGHT's consent.

**EVERLIGHT ELECTRONICS CO., LTD.**  
Office: No 25, Lane 76, Sec 3, Chung Yang Rd,  
Tucheng, Taipei 236, Taiwan, R.O.C

Tel: 886-2-2267-2000, 2267-9936  
Fax: 886-2267-6244, 2267-6189, 2267-6306  
<http://www.everlight.com>