

SUPER BRIGHT T-1 3/4 (5 mm) LED LAMP - Water Clear

PACKAGE DIMENSIONS

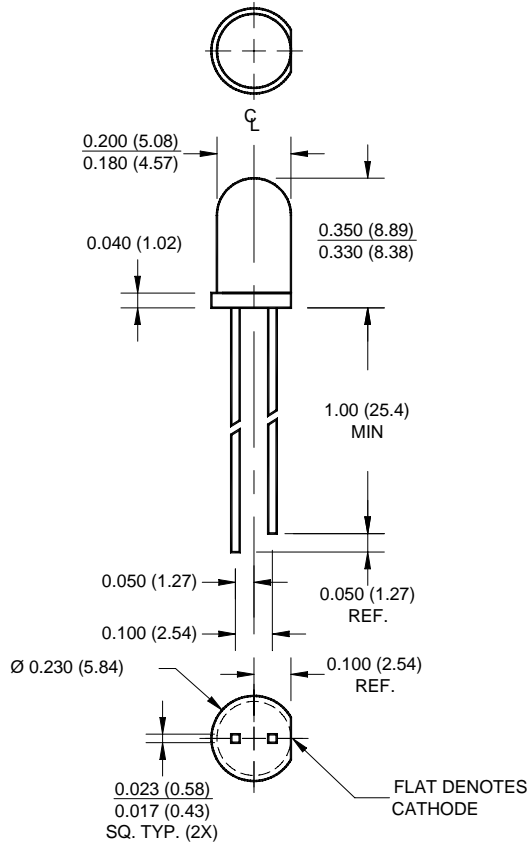

NOTES:

1. Dimensions for all drawings are in inches (mm).
2. Lead spacing is measured where the leads emerge from the package.
3. Protruded resin under the flange is 1.5 mm (0.059") max.

SUPER ORANGE-RED MV880X
MV8803 MV8804
MV8805 MV8806

FEATURES

- Popular T-1 3/4 package
- Super high brightness suitable for outdoor applications
- Solid state reliability
- Water clear optics
- Standard 100 mil. lead spacing

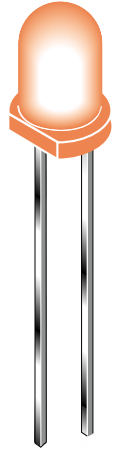

DESCRIPTION

This T-1 3/4 super bright LED has a moderate viewing angle of 20° for concentrated light output. It is made with an AlInGaP LED that emits red light at 630 nm. It is encapsulated in a water clear epoxy lens package.

ABSOLUTE MAXIMUM RATINGS (T_A = 25°C unless otherwise specified)

Parameter	Symbol	Rating	Unit
Operating Temperature	T _{OPR}	-40 to +100	°C
Storage Temperature	T _{STG}	-40 to +100	°C
Lead Soldering Time	T _{SOL}	260 for 5 sec	°C
Continuous Forward Current	I _F	30	mA
Peak Forward Current (f = 1.0 KHz, Duty Factor = 1/10)	I _F	200	mA
Reverse Voltage	V _R	5	V
Power Dissipation	P _D	100	mW

SUPER ORANGE-RED MV880X
MV8803 MV8804
MV8805 MV8806

ELECTRICAL / OPTICAL CHARACTERISTICS (T_A = 25°C)

Part Number	MV8803	MV8804	MV8805	MV8806	Condition
Luminous Intensity (mcd)					I _F = 20 mA
Minimum	630	1000	1600	2500	
Typical	940	1500	2400	3500	
Forward Voltage (V)					I _F = 20 mA
Maximum	2.8	2.8	2.8	2.8	
Typical	2.1	2.1	2.1	2.1	
Wavelength (nm)					I _F = 20 mA
Peak		630			
Dominant		623			
Spectral Line Half Width (nm)		20			I _F = 20 mA
Viewing Angle (°)		20			I _F = 20 mA

TYPICAL PERFORMANCE CURVES

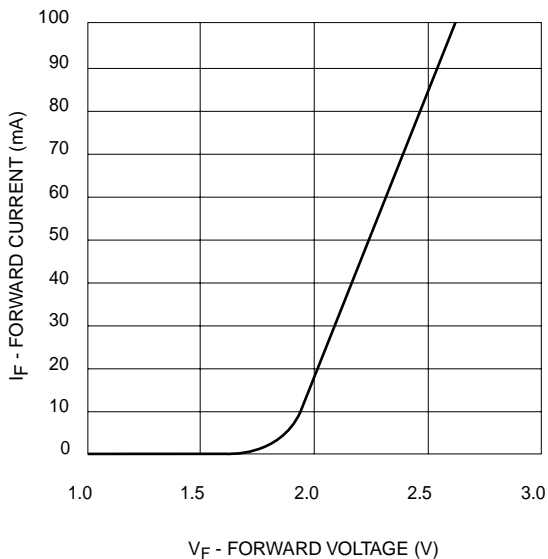

Fig. 1 Forward Current vs. Forward Voltage

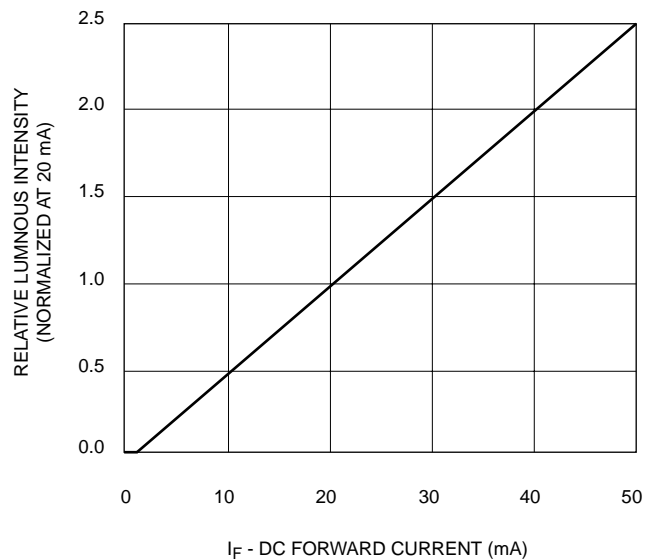

Fig. 2 Relative Luminous Intensity vs. DC Forward Current

SUPER BRIGHT T-1 3/4 (5 mm) LED LAMP - Water Clear

SUPER ORANGE-RED MV880X
MV8803 MV8804
MV8805 MV8806

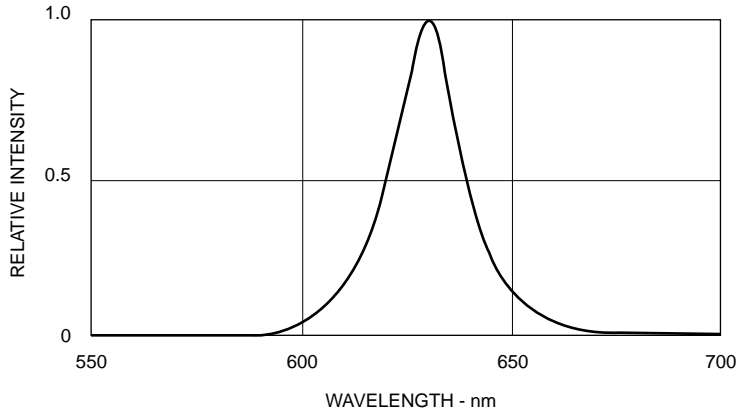
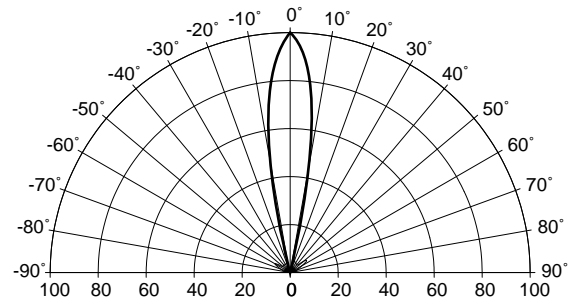

Fig. 3 Relative Intensity vs Peak Wavelength



REL. LUMINOUS INTENSITY (%)

Fig. 4 Radiation Diagram

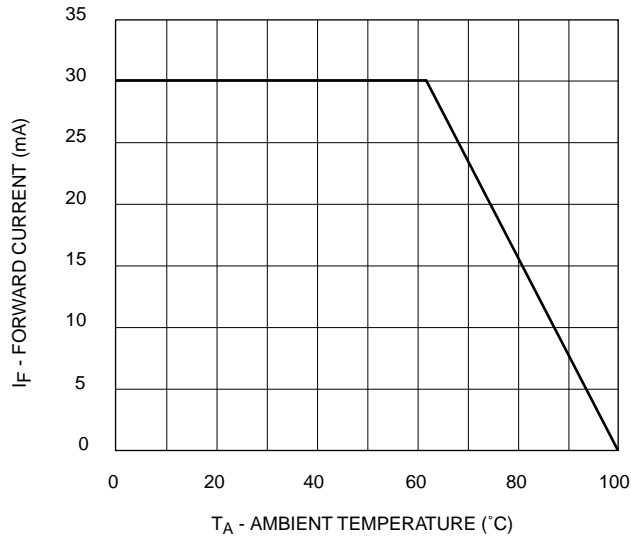

Fig. 5 Current Derating Curve

DISCLAIMER

FAIRCHILD SEMICONDUCTOR RESERVES THE RIGHT TO MAKE CHANGES WITHOUT FURTHER NOTICE TO ANY PRODUCTS HEREIN TO IMPROVE RELIABILITY, FUNCTION OR DESIGN. FAIRCHILD DOES NOT ASSUME ANY LIABILITY ARISING OUT OF THE APPLICATION OR USE OF ANY PRODUCT OR CIRCUIT DESCRIBED HEREIN; NEITHER DOES IT CONVEY ANY LICENSE UNDER ITS PATENT RIGHTS, NOR THE RIGHTS OF OTHERS.

LIFE SUPPORT POLICY

FAIRCHILD'S PRODUCTS ARE NOT AUTHORIZED FOR USE AS CRITICAL COMPONENTS IN LIFE SUPPORT DEVICES OR SYSTEMS WITHOUT THE EXPRESS WRITTEN APPROVAL OF THE PRESIDENT OF FAIRCHILD SEMICONDUCTOR CORPORATION. As used herein:

1. Life support devices or systems are devices or systems which, (a) are intended for surgical implant into the body, or (b) support or sustain life, and (c) whose failure to perform when properly used in accordance with instructions for use provided in the labeling, can be reasonably expected to result in a significant injury of the user.
2. A critical component in any component of a life support device or system whose failure to perform can be reasonably expected to cause the failure of the life support device or system, or to affect its safety or effectiveness.