

Green

MV7442

PACKAGE DIMENSIONS

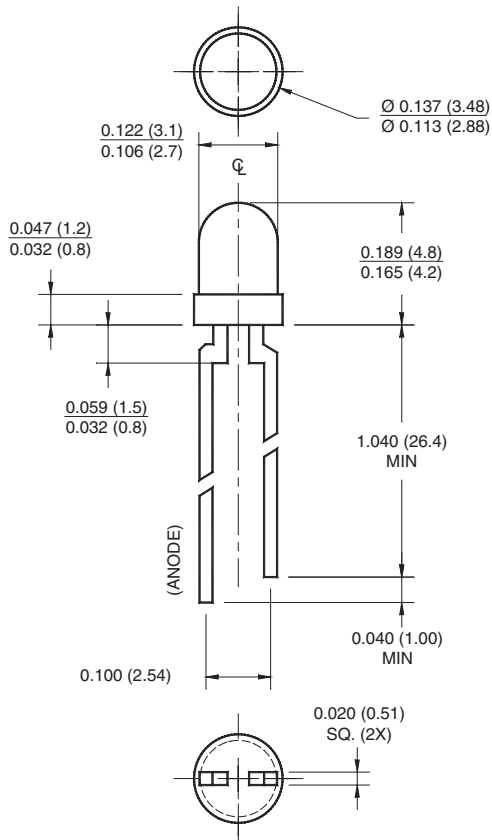

NOTES:

1. Dimensions for all drawings are in inches (mm).
2. Lead spacing is measured where the leads emerge from the package.
3. Protruded resin under the flange is 1.5mm (0.059") max.

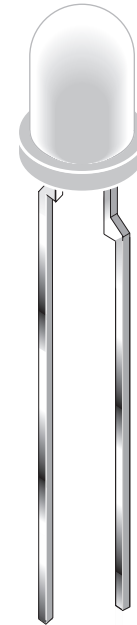

DESCRIPTION

This T-100 green LED has a moderate viewing angle of 45°. It is encapsulated in an epoxy package with a water clear lens. The green diode chip is constructed with GaP technology and emits a dominant wavelength of 570nm.

FEATURES

- Popular T-1 package
- Solid state reliability
- Water clear optics
- Standard 100 mil. lead spacing

Green

MV7442

ABSOLUTE MAXIMUM RATINGS ($T_A = 25^\circ\text{C}$ unless otherwise specified)

Parameter	Symbol	Rating	Unit
Operating Temperature	T_{OPR}	-40 to +85	$^\circ\text{C}$
Storage Temperature	T_{STG}	-40 to +100	$^\circ\text{C}$
Lead Soldering Time	T_{SOL}	260 for 5 sec	$^\circ\text{C}$
Continuous Forward Current	I_F	30	mA
Peak Forward Current ($f = 1.0 \text{ KHz}$, Duty Factor = 1/10)	I_{FM}	120	mA
Reverse Voltage ($I_R = 10 \mu\text{A}$)	V_R	5	V
Power Dissipation	P_D	85	mW

ELECTRICAL / OPTICAL CHARACTERISTICS ($T_A = 25^\circ\text{C}$)

Part Number	MV7442	Condition
Luminous Intensity (mcd)		
Minimum	80	$I_F = 20 \text{ mA}$
Typical	120	
Forward Voltage (V)		
Maximum	2.8	$I_F = 20 \text{ mA}$
Typical	2.1	
Wavelength (nm)		
Peak	565	$I_F = 20 \text{ mA}$
Dominant	570	
Spectral Line Half Width (nm)	30	$I_F = 20 \text{ mA}$
Viewing Angle ($^\circ$)	45	$I_F = 20 \text{ mA}$

Green

MV7442

TYPICAL PERFORMANCE CURVES

Fig.1 Forward Current vs. Forward Voltage

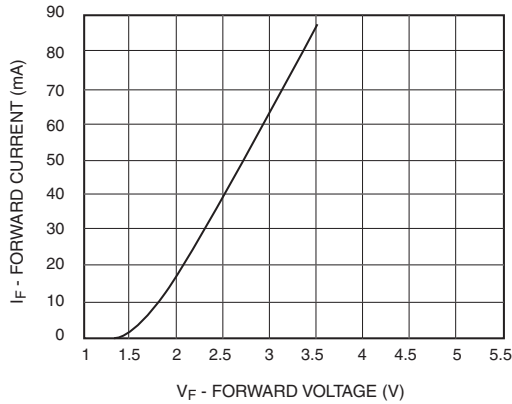

Fig.2 Relative Luminous Intensity vs. DC Forward Current

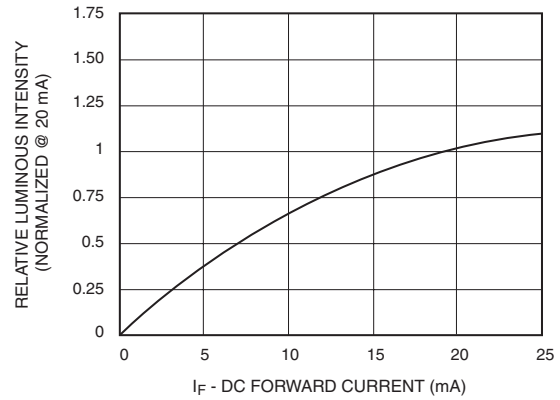

Fig.3 Relative Intensity vs. Peak Wavelength

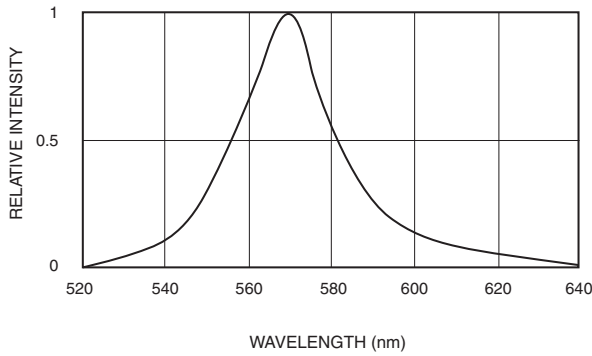

Fig. 4 Radiation Diagram

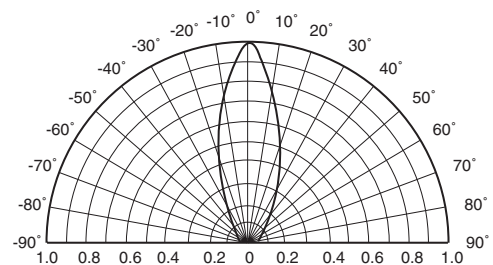
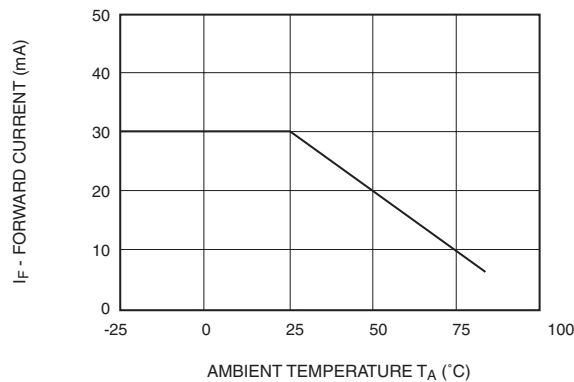

Fig.5 Current Derating Curve



Green

MV7442

DISCLAIMER

FAIRCHILD SEMICONDUCTOR RESERVES THE RIGHT TO MAKE CHANGES WITHOUT FURTHER NOTICE TO ANY PRODUCTS HEREIN TO IMPROVE RELIABILITY, FUNCTION OR DESIGN. FAIRCHILD DOES NOT ASSUME ANY LIABILITY ARISING OUT OF THE APPLICATION OR USE OF ANY PRODUCT OR CIRCUIT DESCRIBED HEREIN; NEITHER DOES IT CONVEY ANY LICENSE UNDER ITS PATENT RIGHTS, NOR THE RIGHTS OF OTHERS.

LIFE SUPPORT POLICY

FAIRCHILD'S PRODUCTS ARE NOT AUTHORIZED FOR USE AS CRITICAL COMPONENTS IN LIFE SUPPORT DEVICES OR SYSTEMS WITHOUT THE EXPRESS WRITTEN APPROVAL OF THE PRESIDENT OF FAIRCHILD SEMICONDUCTOR CORPORATION. As used herein:

1. Life support devices or systems are devices or systems which, (a) are intended for surgical implant into the body, or (b) support or sustain life, and (c) whose failure to perform when properly used in accordance with instructions for use provided in the labeling, can be reasonably expected to result in a significant injury of the user.
2. A critical component in any component of a life support device or system whose failure to perform can be reasonably expected to cause the failure of the life support device or system, or to affect its safety or effectiveness.