

**MV5052  
MV5053/6053**

**MV5054A-1/2/3  
MV5055**

**PACKAGE DIMENSIONS**

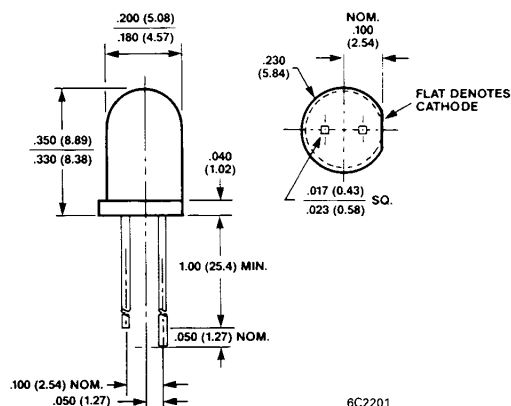

**DESCRIPTION**

The MV505X Series of industry standard solid state indicators is made with gallium arsenide phosphide light emitting diodes encapsulated in epoxy lenses. Various lens effects give different design possibilities.

**FEATURES**

- Standard Red light source with various lens colors and effects
- Versatile mounting on PC board or panel
- Snap in mounting grommet MP52
- Long life—solid state reliability
- Low power requirements
- Compact, rugged, lightweight

**PHYSICAL CHARACTERISTICS**

CATHODE LONG	SOURCE COLOR	LENS TYPE	LENS EFFECT	APPLICATION
MV5052	Standard Red	Red Tint	Point Source	Backlighting
MV5053*	Standard Red	Red Diffused	Wide Beam	Direct View
MV5054A-1	Standard Red	Red Diffused	Narrow Beam	Direct View
MV5054A-2	Standard Red	Red Diffused	Narrow Beam	Direct View
MV5054A-3	Standard Red	Red Diffused	Narrow Beam	Direct View
MV5055	Standard Red	Red Diffused	Very Wide Beam	Direct View

\*MV6053 – Anode Long also available.

<b>ELECTRO OPTICAL CHARACTERISTICS</b> ( $T_A=25^\circ\text{C}$ Unless Otherwise Specified)								
PARAMETER	TEST COND.	5052	6053 5053	5054A-1	5054A-2	5054A-3	5055	UNIT
Luminous Intensity $I_v$ min.	$I_f=20$ mA	0.7	0.5				0.1	mcd
	$I_f=10$ mA			1.0	2.0	3.0		mcd
Forward voltage $V_f$ mcd	$I_f=20$ mA	2.2	2.2				2.2	V
	$I_f=10$ mA			2.2	2.2	2.2		V
Peak wavelengths $\lambda_p$ typical	$I_f=20$ mA	660	660	660	660	660	660	nm
Spectral line half width typical	$I_f=20$ mA	20	20	20	20	20	20	nm
Capacitance typical	$V=0$ $f=1$ MHz	30	30	30	30	30	30	pF
Reverse current $I_R$ max.	$V_R=5.0$ V	100	100	100	100	100	100	$\mu\text{A}$
Viewing angle typical, See Figures		72	80	24	24	24	150	degrees

<b>ABSOLUTE MAXIMUM RATINGS</b> ( $T_A=25^\circ\text{C}$ Unless Otherwise Specified)	
Power dissipation	180 mW
Derate linearly from 25°	2.0 mW/°C
Storage and operating temperatures	-55°C to +100°C
Lead soldering time at 260°C (See Note 2)	5 sec.
Continuous forward current	100 mA
Peak forward current (1 $\mu$ sec pulse, 0.3% duty cycle)	1.0 A
Reverse voltage	5.0 V

<b>NOTES</b>
1. The axis of spatial distribution are typically within a 10° cone with reference to the central axis of the device.
2. The leads of the device were immersed in molten solder at 260°C to a point 1/16(1.6 mm) from the body of the device per MIL-S-750, with a dwell time of 5 seconds.

**TYPICAL ELECTRO-OPTICAL CHARACTERISTICS (25°C Free Air Temperature)**

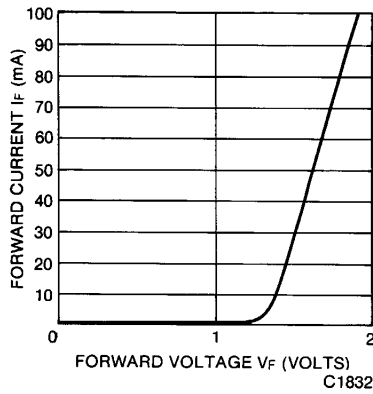

Fig. 1. Forward Current vs. Forward Voltage

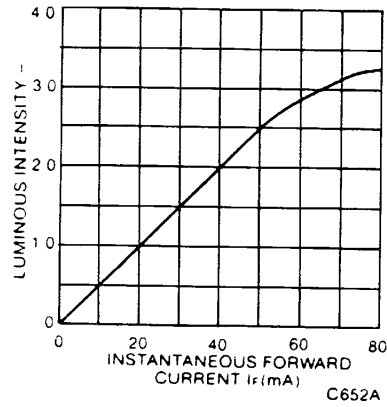

Fig. 2. Luminous Intensity vs. Forward Current

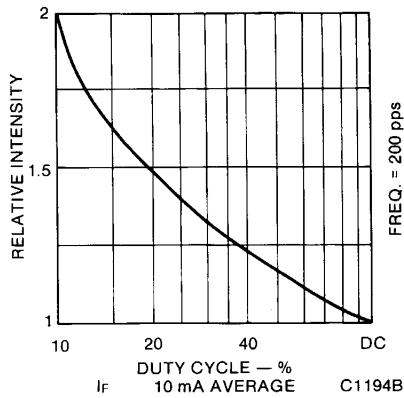

Fig. 3. Luminous Intensity vs. Duty Cycle

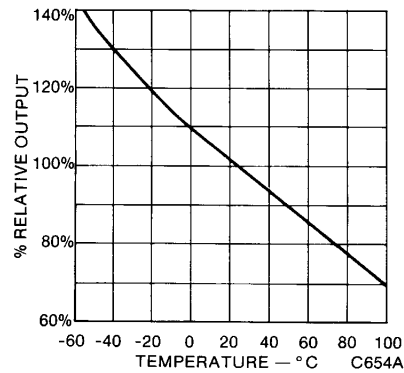

Fig. 4. Output vs. Temperature

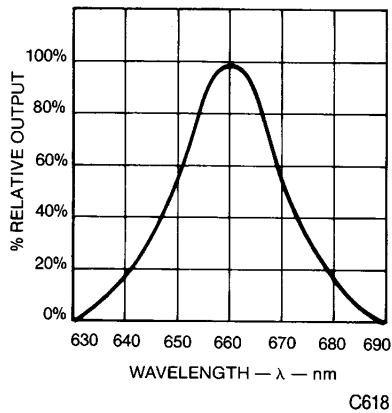

Fig. 5. Spectral Distribution

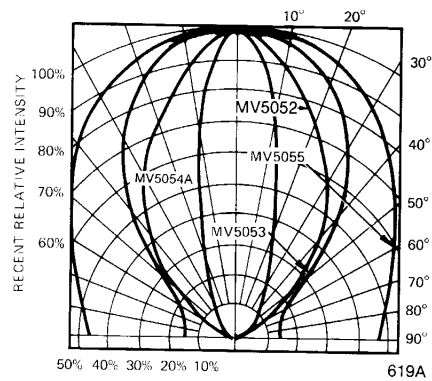

Fig. 6. Spatial Distribution (Note 1)



## STANDARD RED T-1 3/4 SOLID STATE LAMPS

---

### **DISCLAIMER**

FAIRCHILD SEMICONDUCTOR RESERVES THE RIGHT TO MAKE CHANGES WITHOUT FURTHER NOTICE TO ANY PRODUCTS HEREIN TO IMPROVE RELIABILITY, FUNCTION OR DESIGN. FAIRCHILD DOES NOT ASSUME ANY LIABILITY ARISING OUT OF THE APPLICATION OR USE OF ANY PRODUCT OR CIRCUIT DESCRIBED HEREIN; NEITHER DOES IT CONVEY ANY LICENSE UNDER ITS PATENT RIGHTS, NOR THE RIGHTS OF OTHERS.

### **LIFE SUPPORT POLICY**

FAIRCHILD'S PRODUCTS ARE NOT AUTHORIZED FOR USE AS CRITICAL COMPONENTS IN LIFE SUPPORT DEVICES OR SYSTEMS WITHOUT THE EXPRESS WRITTEN APPROVAL OF THE PRESIDENT OF FAIRCHILD SEMICONDUCTOR CORPORATION. As used herein:

1. Life support devices or systems are devices or systems which, (a) are intended for surgical implant into the body, or (b) support or sustain life, and (c) whose failure to perform when properly used in accordance with instructions for use provided in the labeling, can be reasonably expected to result in a significant injury of the user.
2. A critical component in any component of a life support device or system whose failure to perform can be reasonably expected to cause the failure of the life support device or system, or to affect its safety or effectiveness.