

EVERLIGHT

MSQC6112C, MSQC6142C, MSQC6912C, MSQC6942C, MSQC6412C, MSQC6442C 14mm (0.56 inch) Four Digit Multiplex Clock Stick Display

Bright Red: MSQC6112C
MSQC6142C
High Efficiency Red: MSQC6912C
MSQC6942C
Green: MSQC6412C
MSQC6442C

Features

- Bright Bold Segments
- Common Anode/Cathode
- Low Power Consumption
- Low Current Capability
- High Performance
- High Reliability

Applications

- Appliances
- Automotive
- Instrumentation
- Process Control

Package Dimensions

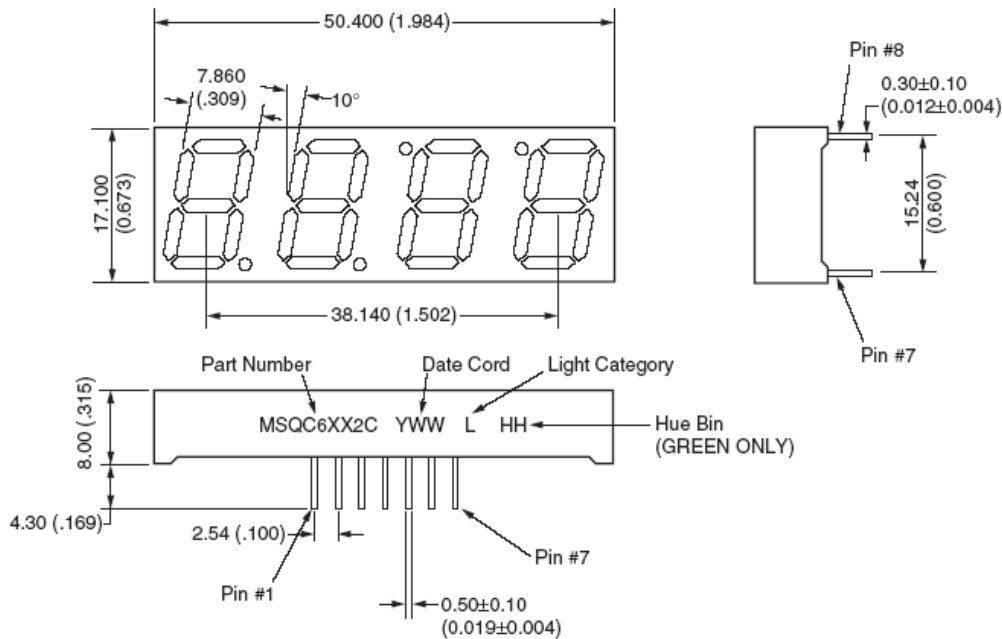

Notes:

- Dimensions are in mm (inches)
- Tolerances are ±0.25mm (0.010") unless otherwise stated.

MSQC6112C, MSQC6142C, MSQC6912C, MSQC6942C, MSQC6412C, MSQC6442C 14mm (0.56 inch) Four Digit Multiplex Clock Stick Display

Models Available

Part Number	Colour	Description
MSQC6112C	Bright Red	Clock Display, Common Anode, gray face, neutral segments
MSQC6142C	Bright Red	Clock Display, Common Cathode, gray face, neutral segments
MSQC6412C	Green	Clock Display, Common Anode, gray face, green segments
MSQC6442C	Green	Clock Display, Common Cathode, gray face, green segments
MSQC6912C	H.E.R.	Clock Display, Common Anode, gray face, neutral segments
MSQC6942C	H.E.R.	Clock Display, Common Cathode, gray face, neutral segments

(For other colour options, contact your local area Sales Manager)

Absolute Maximum Ratings⁽¹⁾ ($T_A = 25^\circ\text{C}$, unless otherwise specified)

Part Number Parameter	MSQC6112C MSQC6142C	MSQC6412C MSQC6442C	MSQC6912C MSQC6942C	Units
Continuous Forward Current (each segment)	15	25	25	mA
Peak Forward Current ($F = 10\text{KHz}$, $D/F = 1/10$)	60	90	90	mA
Power Dissipation (P_D)	40	70	70	mW
*Derate Linearly from 25°C	0.17	0.33	0.33	mW
Reverse Voltage per Die	5 Volts			
Operating and Storage Temperature Range	-40°C to +85°C			
Lead soldering time (1/16 inch from standoff)	5 seconds @ 230°C			

Electro-Optical Characteristics⁽¹⁾ ($T_A = 25^\circ\text{C}$, unless otherwise specified)

Part Number Parameter	MSQC6112C MSQC6142C	MSQC6412C MSQC6442C	MSQC6912C MSQC6912C	Units	Test Condition
Luminous intensity ⁽²⁾ (I_V)					
Minimum (Standard Current)	300	800	800	μcd	$I_F = 10\text{mA}$
Typical (Standard Current)	700	2400	2000	μcd	$I_F = 10\text{mA}$
Minimum (Low Current)	Not Available				
Typical (Low Current)	Not Available				
Forward Voltage (V_F)					
Typical (Standard Current)	2.10	2.10	2.00	V	$I_F = 20\text{mA}$
Maximum (Standard Current)	2.80	2.80	2.80	V	$I_F = 20\text{mA}$
Typical (Low Current)	Not Available				
Maximum (Low Current)	Not Available				
Peak Wavelength	695	570	635	nm	$I_F = 20\text{mA}$
Dominant Wavelength	Not Available				
Spectral Line 1/2 Width	90	30	45	nm	$I_F = 10\text{mA}$
Reverse B ⁽³⁾ . Voltage (V_R)	5	5	5	V	$I_R = 100\mu\text{A}$

NOTES:

(1) Data per individual LED element

(2) Luminous intensity (μcd) = average light output per segment

(3) B = breakdown

<http://www.everlight.com>

Pin Orientation, Segment Identification, and Product Marking

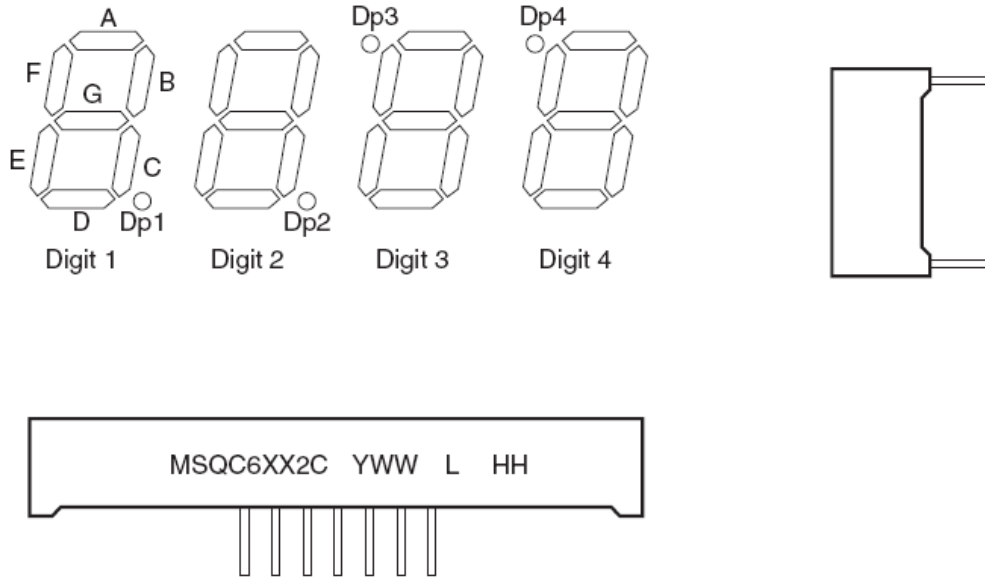

Schematics

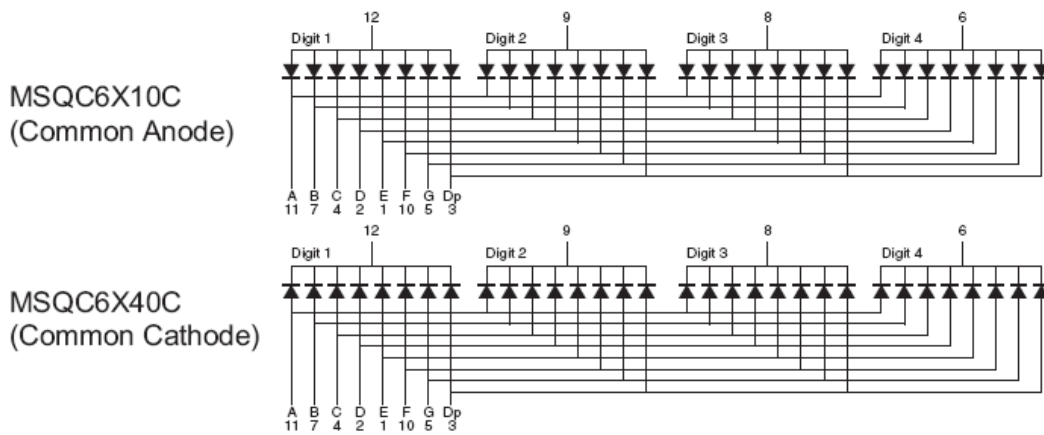

MSQC6112C, MSQC6142C, MSQC6912C, MSQC6942C, MSQC6412C, MSQC6442C 14mm (0.56 inch) Four Digit Multiplex Clock Stick Display

<http://www.everlight.com>

Graphical Data Bright Red ($T_A = 25^\circ\text{C}$, unless otherwise specified)

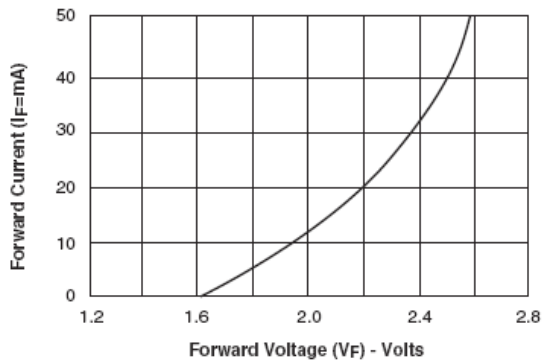

Fig. 1 Forward Current vs. Forward Voltage

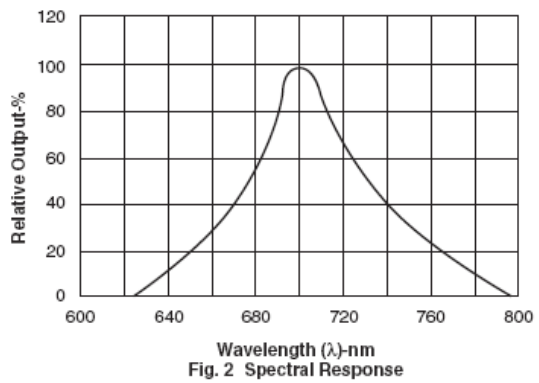

Fig. 2 Spectral Response

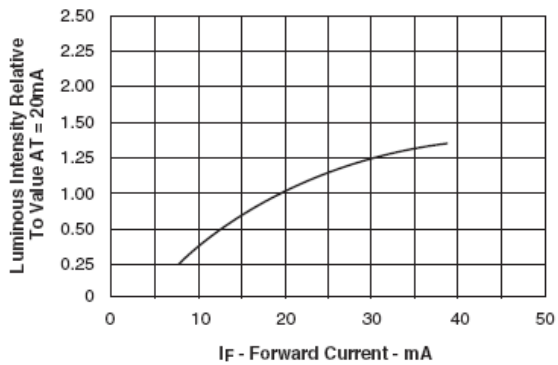

Fig. 3 Relative Luminous Intensity vs. Forward Current

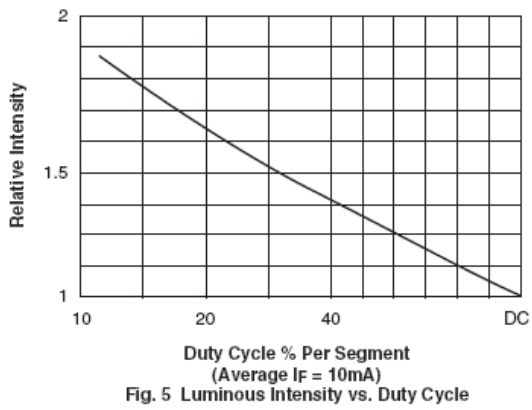

Fig. 5 Luminous Intensity vs. Duty Cycle

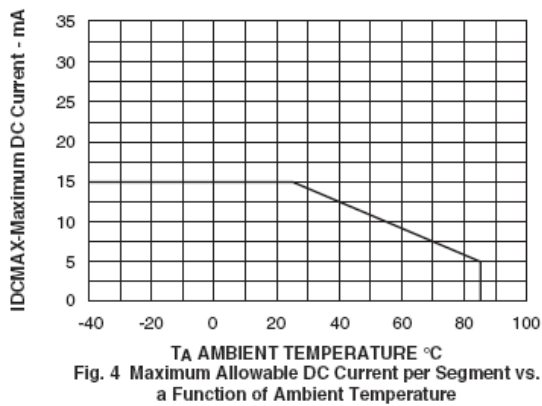

Fig. 4 Maximum Allowable DC Current per Segment vs. a Function of Ambient Temperature

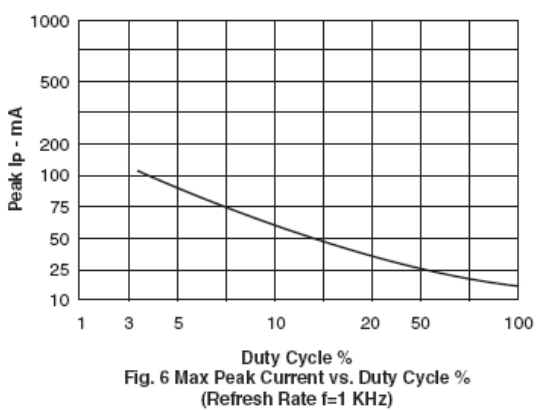

Fig. 6 Max Peak Current vs. Duty Cycle % (Refresh Rate f=1 KHz)

Graphical Data Green (TA = 25°C, unless otherwise specified)

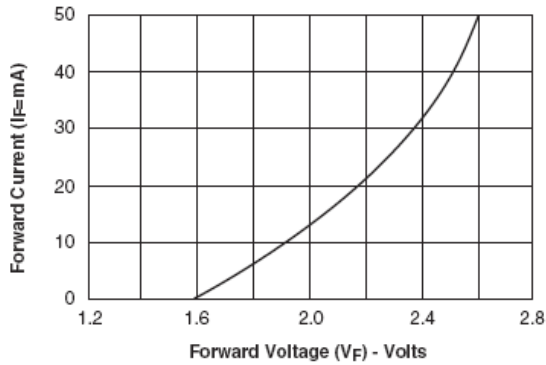

Fig. 1 Forward Current vs. Forward Voltage

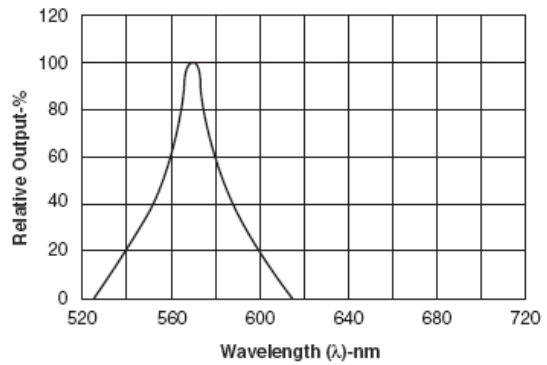

Fig. 2 Spectral Response

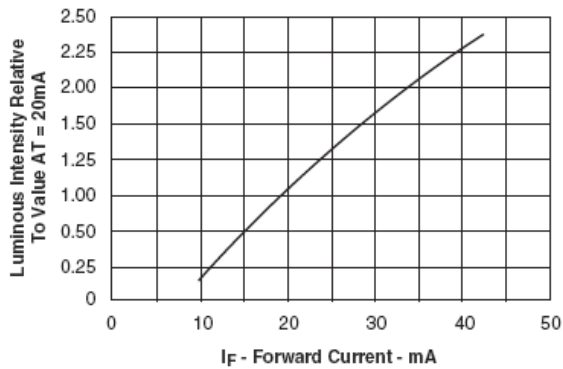

Fig. 3 Relative Luminous Intensity vs. Forward Current

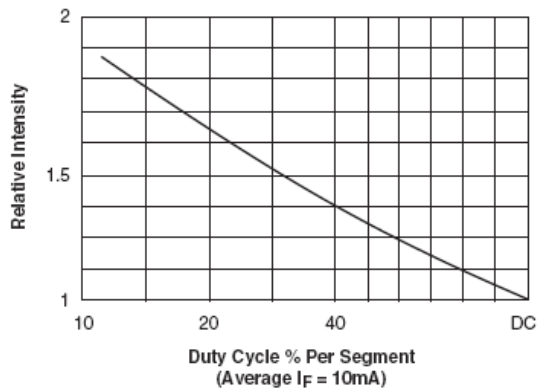

Fig. 5 Luminous Intensity vs. Duty Cycle

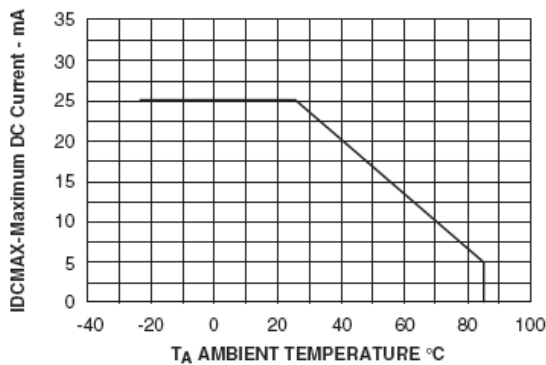

Fig. 4 Maximum Allowable DC Current per Segment vs. a Function of Ambient Temperature

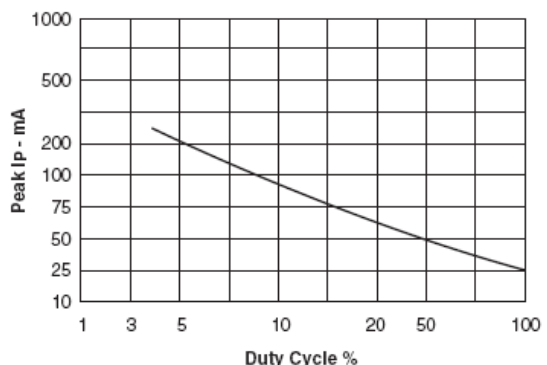

Fig. 6 Max Peak Current vs. Duty Cycle % (Refresh Rate f=1 KHz)

Graphical Data High Efficiency Red ($T_A = 25^\circ\text{C}$, unless otherwise specified)

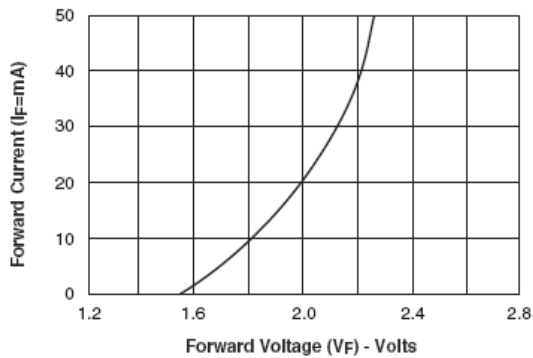

Fig. 1 Forward Current vs. Forward Voltage

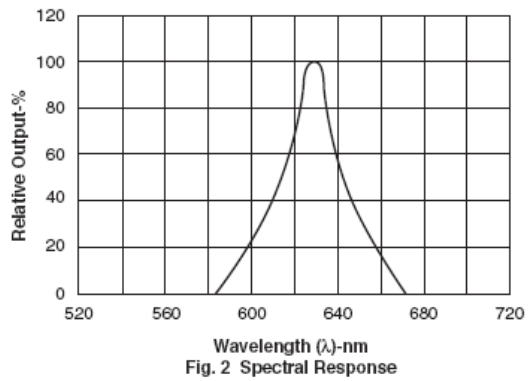

Fig. 2 Spectral Response

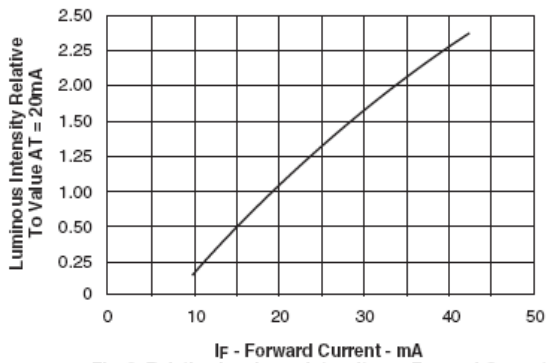

Fig. 3 Relative Luminous Intensity vs. Forward Current

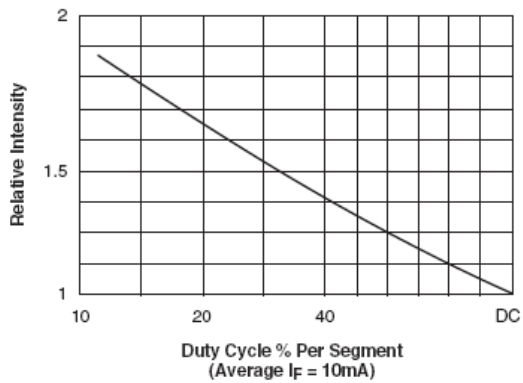

Fig. 5 Luminous Intensity vs. Duty Cycle

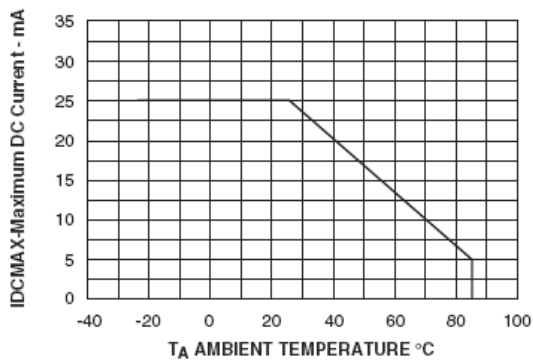

Fig. 4 Maximum Allowable DC Current per Segment vs. a Function of Ambient Temperature

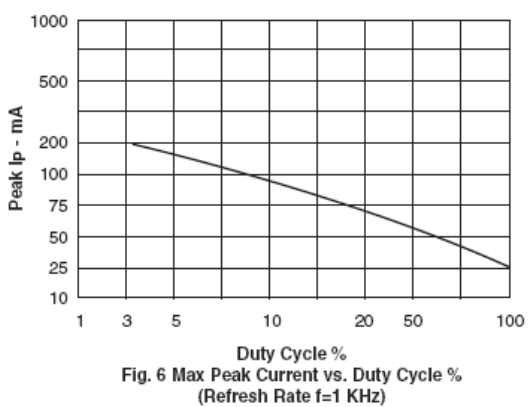

Fig. 6 Max Peak Current vs. Duty Cycle % (Refresh Rate f=1 KHz)

TRADEMARKS

The following are registered and unregistered trademarks Fairchild Semiconductor owns or is authorized to use and is not intended to be an exhaustive list of all such trademarks.

ACEx™	FAST®	ISOPLANAR™	PowerSaver™	SuperSOT™-8
ActiveArray™	FASTr™	LittleFET™	PowerTrench®	SyncFET™
Bottomless™	FPS™	MICROCOUPLER™	QFET®	TinyLogic®
Build it Now™	FRFET™	MicroFET™	QST™	TINYOPTO™
CoolFET™	GlobalOptoisolator™	MicroPak™	QT Optoelectronics™	TruTranslation™
CROSSVOLT™	GTO™	MICROWIRE™	Quiet Series™	UHC™
DOME™	HiSeC™	MSX™	RapidConfigure™	UltraFET®
EcoSPARK™	I ² C™	MSXPro™	RapidConnect™	UniFET™
E ³ CMOS™	i-Lo™	OCX™	µSerDes™	VCX™
EnSigna™	ImpliedDisconnect™	OCXPro™	SILENT SWITCHER®	Wire™
FACT™	IntelliMAX™	OPTOLOGIC®	SMART START™	
FACT Quiet Series™		OPTOPLANAR™	SPM™	
Across the board. Around the world.™		PACMAN™	Stealth™	
The Power Franchise®		POP™	SuperFET™	
Programmable Active Droop™		Power247™	SuperSOT™-3	
		PowerEdge™	SuperSOT™-6	

DISCLAIMER

FAIRCHILD SEMICONDUCTOR RESERVES THE RIGHT TO MAKE CHANGES WITHOUT FURTHER NOTICE TO ANY PRODUCTS HEREIN TO IMPROVE RELIABILITY, FUNCTION OR DESIGN. FAIRCHILD DOES NOT ASSUME ANY LIABILITY ARISING OUT OF THE APPLICATION OR USE OF ANY PRODUCT OR CIRCUIT DESCRIBED HEREIN; NEITHER DOES IT CONVEY ANY LICENSE UNDER ITS PATENT RIGHTS, NOR THE RIGHTS OF OTHERS.

LIFE SUPPORT POLICY

FAIRCHILD'S PRODUCTS ARE NOT AUTHORIZED FOR USE AS CRITICAL COMPONENTS IN LIFE SUPPORT DEVICES OR SYSTEMS WITHOUT THE EXPRESS WRITTEN APPROVAL OF FAIRCHILD SEMICONDUCTOR CORPORATION. As used herein:

1. Life support devices or systems are devices or systems which, (a) are intended for surgical implant into the body, or (b) support or sustain life, or (c) whose failure to perform when properly used in accordance with instructions for use provided in the labeling, can be reasonably expected to result in significant injury to the user.

2. A critical component is any component of a life support device or system whose failure to perform can be reasonably expected to cause the failure of the life support device or system, or to affect its safety or effectiveness.

PRODUCT STATUS DEFINITIONS

Definition of Terms

Datasheet Identification	Product Status	Definition
Advance Information	Formative or In Design	This datasheet contains the design specifications for product development. Specifications may change in any manner without notice.
Preliminary	First Production	This datasheet contains preliminary data, and supplementary data will be published at a later date. Fairchild Semiconductor reserves the right to make changes at any time without notice in order to improve design.
No Identification Needed	Full Production	This datasheet contains final specifications. Fairchild Semiconductor reserves the right to make changes at any time without notice in order to improve design.
Obsolete	Not In Production	This datasheet contains specifications on a product that has been discontinued by Fairchild semiconductor. The datasheet is printed for reference information only.

Rev. 116