

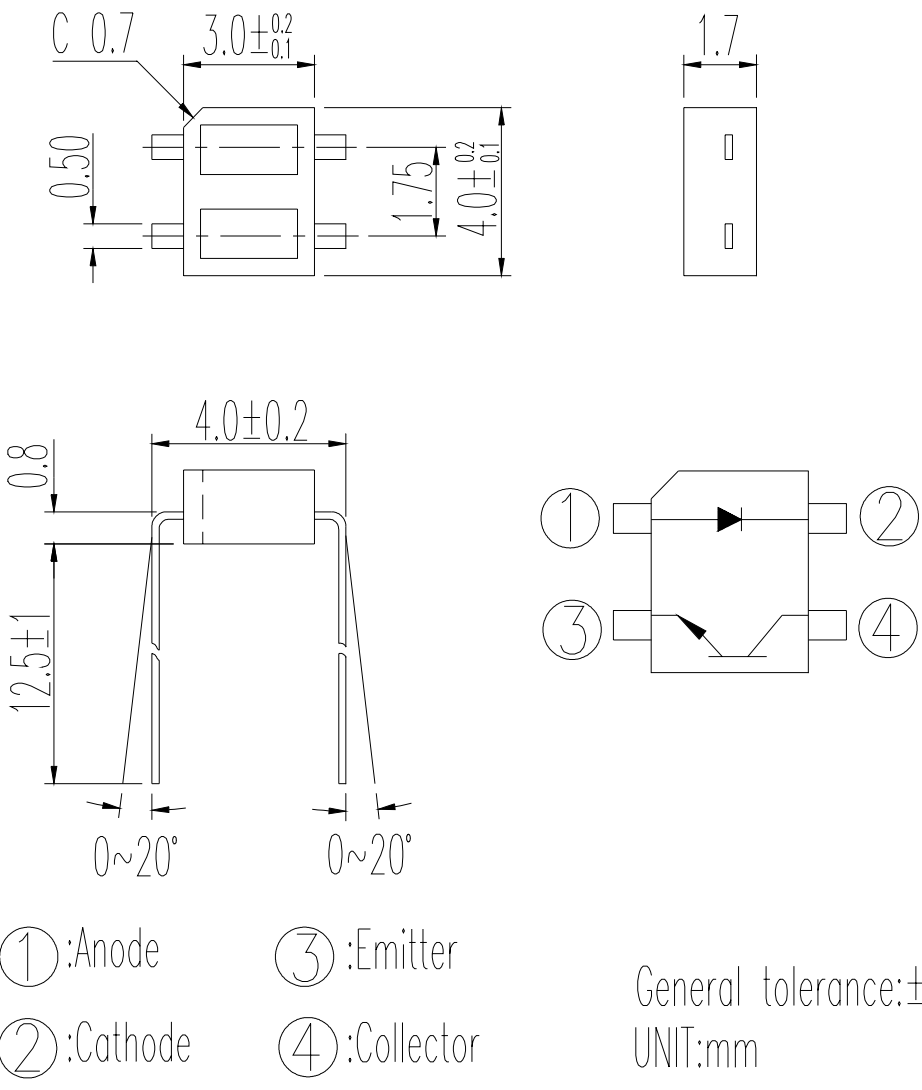

**Package Dimensions**



- ① :Anode
- ② :Cathode
- ③ :Emitter
- ④ :Collector

General tolerance: ±0.15mm  
UNIT:mm

- Notes:**
- 1.All dimensions are in millimeters
  - 2.Tolerances unless dimensions ±0.25mm

**Absolute Maximum Ratings (Ta=25 )**

Parameter		Symbol	Ratings	Unit
Input	Power Dissipation at(or below) 25 Free Air Temperature	Pd	130	mW
	Reverse Voltage	V <sub>R</sub>	5	V
	Forward Current	I <sub>F</sub>	50	mA
	Peak Forward Current (*1) Pulse width 100 μ s, Duty cycle=1%	I <sub>FP</sub>	1	A
Output	Collector Power Dissipation	P <sub>C</sub>	75	mW
	Collector Current	I <sub>C</sub>	50	mA
	Collector-Emitter Voltage	B V <sub>CEO</sub>	30	V
	Emitter-Collector Voltage	B V <sub>ECO</sub>	5	V
Operating Temperature		Topr	-25~+85	
Storage Temperature		Tstg	-30~+85	
Lead Soldering Temperature (*2)		Tsol	260	

(\* 1) tw=100 μ sec. , T=10 msec. (\* 2) t=5 Sec

**Electro-Optical Characteristics (Ta=25 )**

Parameter		Symbol	Min.	Typ.	Max.	Unit	Conditions	
Input	Forward Voltage	V <sub>F</sub>	-	1.2	1.6	V	I <sub>F</sub> =20mA	
	Reverse Current	I <sub>R</sub>	-	-	10	μ A	V <sub>R</sub> =5V	
	Peak Wavelength	P	-	940	-	nm	-	
Output	Dark Current	I <sub>CEO</sub>	-	-	0.1	μ A	V <sub>CE</sub> =20V,	
Transfer Characteristics	Collector Current	I <sub>C(ON)</sub>	B	34	-	71	uA	V <sub>CE</sub> =2V, I <sub>F</sub> =4mA
			C	20	-	90		
	Leakage Current	I <sub>CEOD</sub>	-	-	1	μ A	V <sub>CE</sub> =5V, I <sub>F</sub> =10mA	
	Rise time	t <sub>r</sub>	-	20	-	μ s	V <sub>CE</sub> =2V I <sub>C</sub> =100uA R <sub>L</sub> =1000Ω	
	Fall time	t <sub>f</sub>	-	20	-	μ s		

**Typical Electrical/Optical/Characteristics Curves for IR**

Fig. 1 Forward Current vs. Ambient Temperature

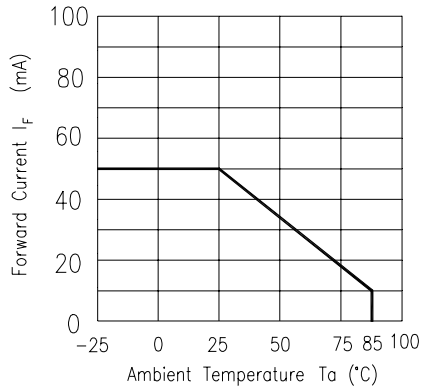

Fig. 2 Spectral Distribution

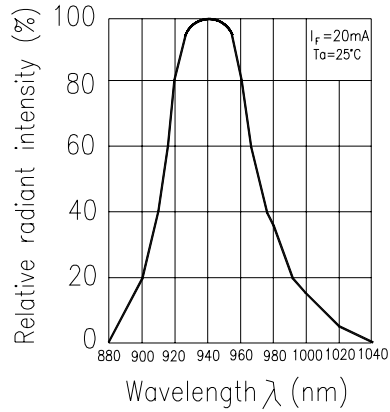

Fig. 3 Peak Emission Wavelength vs. Ambient Temperature

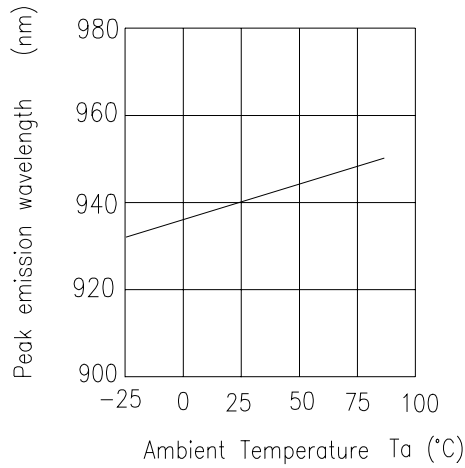

Fig. 4 Forward Current vs. Forward Voltage

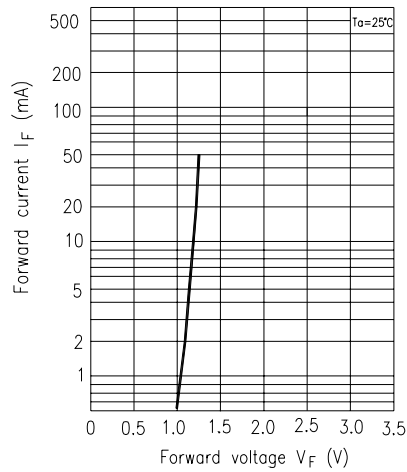

Fig. 5 Forward Voltage vs. Ambient Temperature

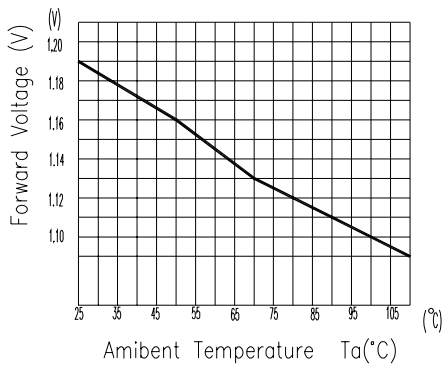
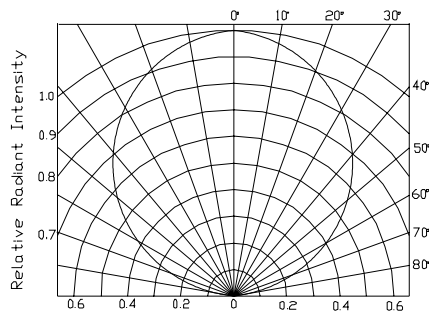

Fig. 6 Relative Radiant Intensity vs. Angular Displacement



Typical Electrical/Optical/Characteristics Curves for PT

Fig.1 Collector Power Dissipation vs. Ambient Temperature

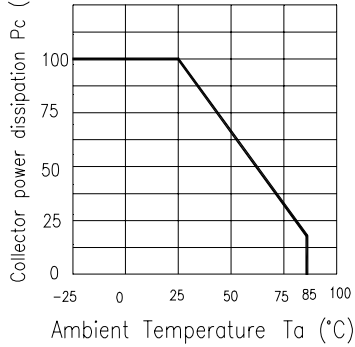

Fig.2 Collector Dark Current vs. Ambient Temperature

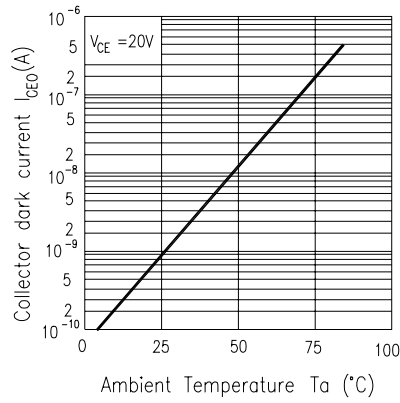

Fig. 3 Relative Collector Current vs. Ambient Temperature

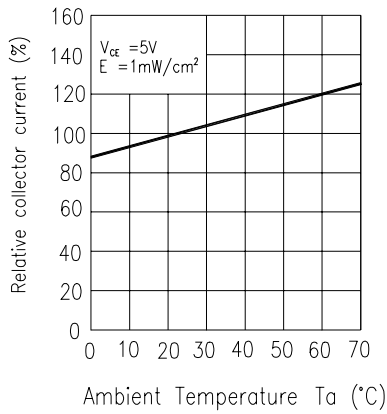

Fig.4 Collector Current vs. Irradiance

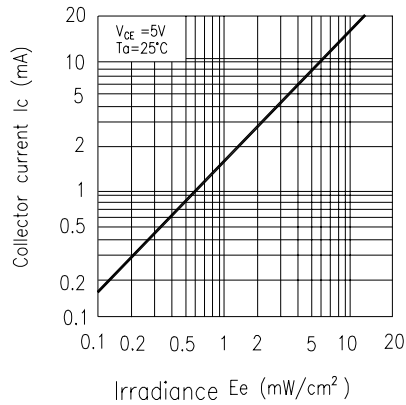

Fig.5 Spectral Sensitivity

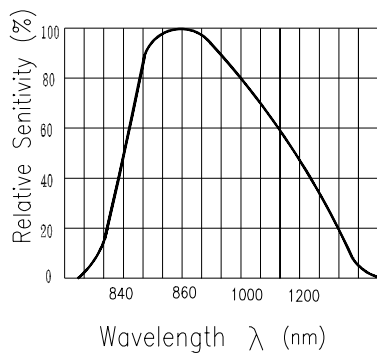
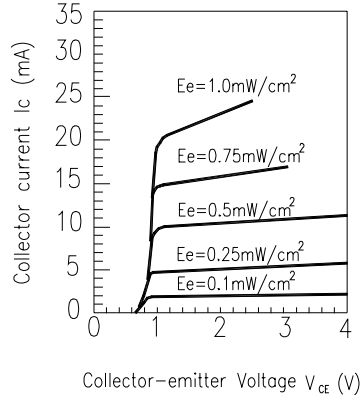

Fig.6 Collector Current vs. Collector-emitter Voltage



**Typical Electrical/Optical/Characteristics Curves for ITR**

Fig.7 Relative Collector Current vs. Distance between Sensor and Al Evaporation Galss

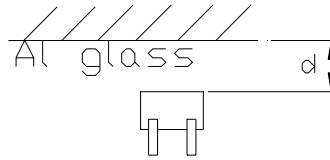
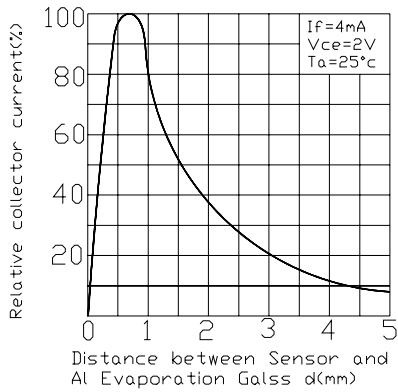

Fig.8 Relative Collector Current vs. Card Moving Distance (l)

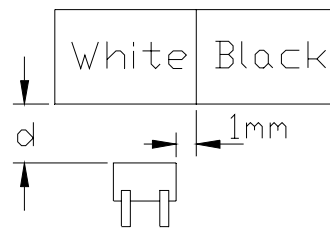
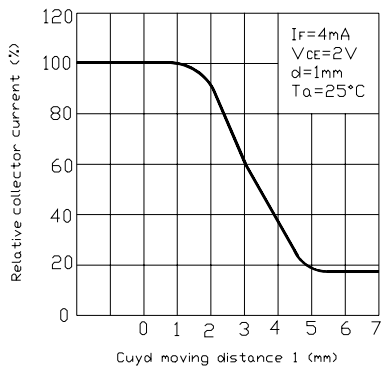
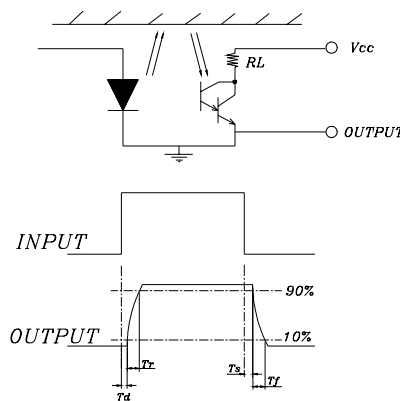
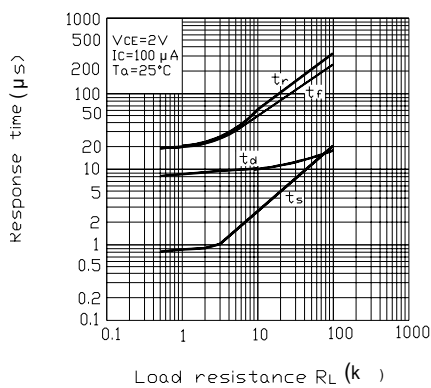

Fig.9 Response Time vs. Load Resistance



## Reliability Test Item And Condition

The reliability of products shall be satisfied with items listed below.

Confidence level : 90%

LTPD : 10%

NO.	Item	Test Conditions	Test Hours/ Cycles	Sample Sizes	Failure Judgement Criteria	Ac/Re
1	Solderability	TEMP. : 230 ±5	5secs	22pcs	More than 90% of lead to be covered by soldering	0/1
2	Temperature Cycle	H : +85 ↕ 5mins L : -55 30mins	50Cycles	22pcs	$I_R \quad U \times 2$ $E_e \quad L \times 0.8$ $V_F \quad U \times 1.2$	0/1
3	Thermal Shock	H : +100 ↕ 5mins 10secs L : -10 5mins	50Cycles	22pcs	U : Upper Specification	0/1
4	High Temperature Storage	TEMP. : +100	1000hrs	22pcs	Limit L : Lower	0/1
5	Low Temperature Storage	TEMP. : -55	1000hrs	22pcs	Specification Limit	0/1
6	DC Operating Life	$I_F=20mA \quad V_{ce}=5V$	1000hrs	22pcs		0/1
7	High Temperature/ High Humidity	85 / 85% R.H	1000hrs	22pcs		0/1

## Recommended Method of Storage

The following are general recommendations for moisture sensitive level (MSL) 4 storage and use:

- Shelf life in sealed bag: 12 months at < 40 °C and < 90% relative humidity (RH)
- After bag is opened, devices that will be subjected to reflow solder or other high temperature process must
  - a) Mounted within 72 hours of factory conditions < 30 °C/60%RH, or
  - b) Stored at <20% RH
    - Devices require bake, before mounting, if:  
Humidity Indicator Card is > 20% when read at 23 ± 5 °C
- If baking is required, devices may be baked:
  - a) 192 hours at 40 ,and <5% RH(dry air/nitrogen) or
  - b) 96 hours at 60 ,and <5% RH for all device containers
  - c) 24 hours at 125 °C

### Packing Specifications

1. 100 Pcs/1 Tube
2. 44 Tube /1 Box
3. 6 Box/ 1 Carton

### Label Form Specification

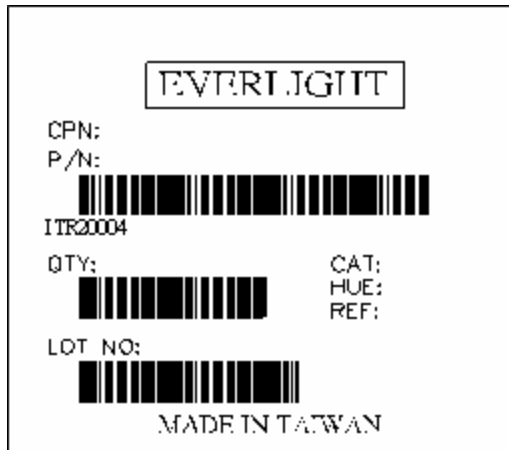

CPN: Customer's Production Number  
P/N : Production Number  
QTY: Packing Quantity  
CAT: None  
HUE: None  
REF: Reference  
LOT No: Lot Number  
MADE IN TAIWAN: Production Place

### Notes

1. Above specification may be changed without notice. EVERLIGHT will reserve authority on material change for above specification.
2. When using this product, please observe the absolute maximum ratings and the instructions for using outlined in these specification sheets. EVERLIGHT assumes no responsibility for any damage resulting from use of the product which does not comply with the absolute maximum ratings and the instructions included in these specification sheets.
3. These specification sheets include materials protected under copyright of EVERLIGHT corporation. Please don't reproduce or cause anyone to reproduce them without EVERLIGHT's consent.

**EVERLIGHT ELECTRONICS CO., LTD.**  
Office: No 25, Lane 76, Sec 3, Chung Yang Rd,  
Tucheng, Taipei 236, Taiwan, R.O.C

Tel: 886-2-2267-2000, 2267-9936  
Fax: 886-2267-6244, 2267-6189, 2267-6306  
<http://www.everlight.com>