



Technical Data Sheet

1.6mm Side Looking Infrared Emitting Diode

IR958-8P

■ Features

- Low forward voltage
- Peak wavelength $\lambda_p=950\text{nm}$
- High reliability
- Pb free
- The product itself will remain within RoHS compliant version.



■ Descriptions

The IR958-8P is a GaAs infrared emitting diode. The miniature side-facing device is a chip that emits radiation from the side of the pink clear package.

■ Applications

- VCR
- Floppy disk drive
- Automatic stroboscope
- Cassette type recorder
- Optoelectronic switch
- Photo interrupter

■ Device Selection Guide

Part No.	Chip	Lens Color
	Material	
IR	GaAs	Pink

Package Dimensions

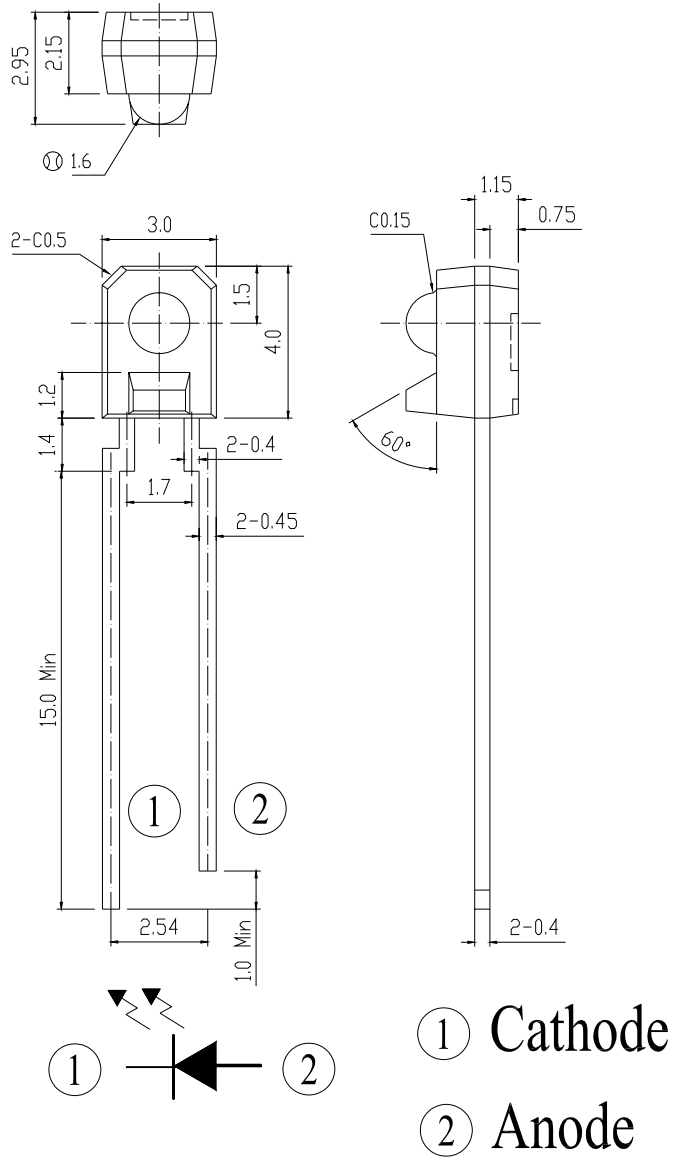

Notes: 1.All dimensions are in millimeters
2.Tolerances unless dimensions ± 0.2 mm

Absolute Maximum Ratings (Ta=25°C)

Item	Symbol	Rating	Unit
Power Dissipation	P _D	75	mW
Reverse Voltage	V _R	6	V
Forward Current	I _F	50	mA
Peak Forward Current (*1)	I _{FP}	1	A
Operating Temperature	Topr	-25~+85	°C
Storage Temperature	Tstg	-40~+85	°C
Soldering Temperature (1/16 inch from body for 5 seconds)	Tsol	260	°C

Notes: (*1) tw=100μ secs. T=10 m secs.

Electro-Optical Characteristics (Ta=25°C)

Parameter	Symbol	Min	Typ	Max	Unit	Condition
Collector Current	I _{c(on)}	300	-	2000	μ A	I _F =4mA, V _{CE} =3.5V
Peak Wavelength	λ _p	-	950	-	nm	I _F =20mA
Spectral Bandwidth	Δλ	-	80	-	nm	I _F =20mA
View Angle	2θ 1/2	-	±11	-	Deg	I _F =20mA
Forward Voltage	V _F	-	1.2	1.5	V	I _F =20mA
Reverse Current	I _R	-	-	10	μ A	V _R =6V

Device No:DIR-958-142

Typical Electro-Optical Characteristics Curves

Fig.1 Forward Current vs. Ambient Temperature

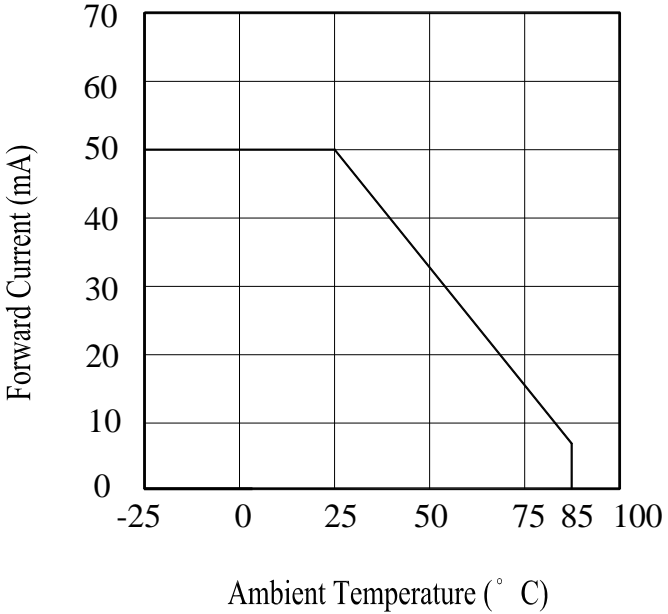

Fig.2 Spectral Distribution

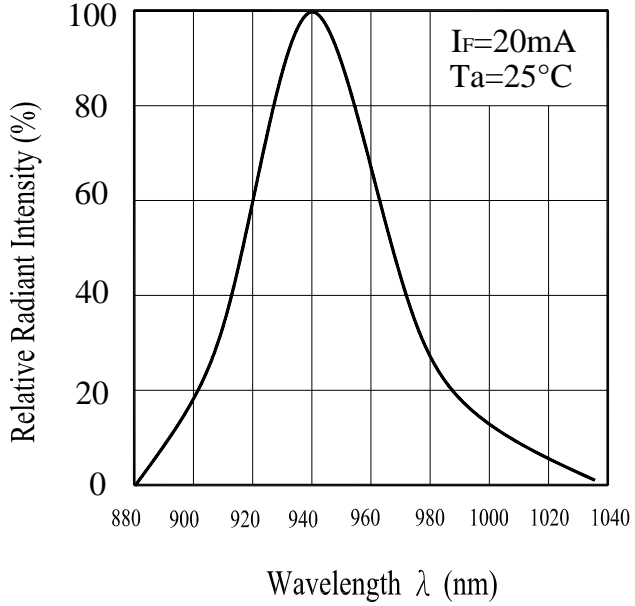

Fig.3 Peak Emission Wavelength vs. Ambient Temperature

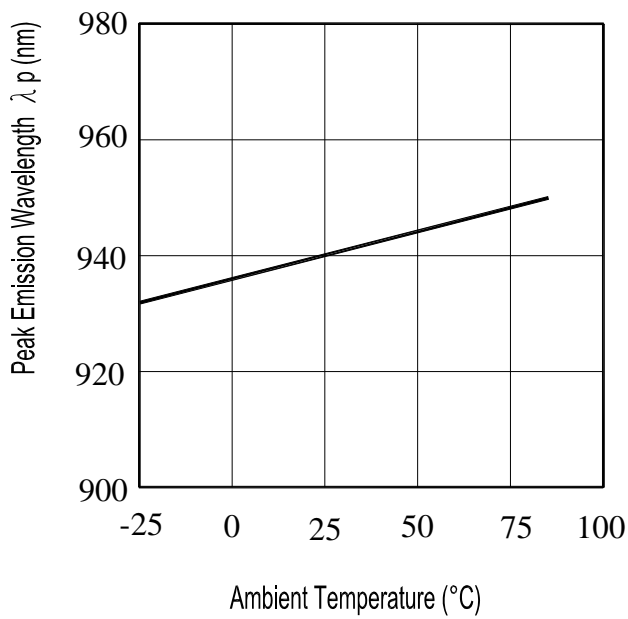
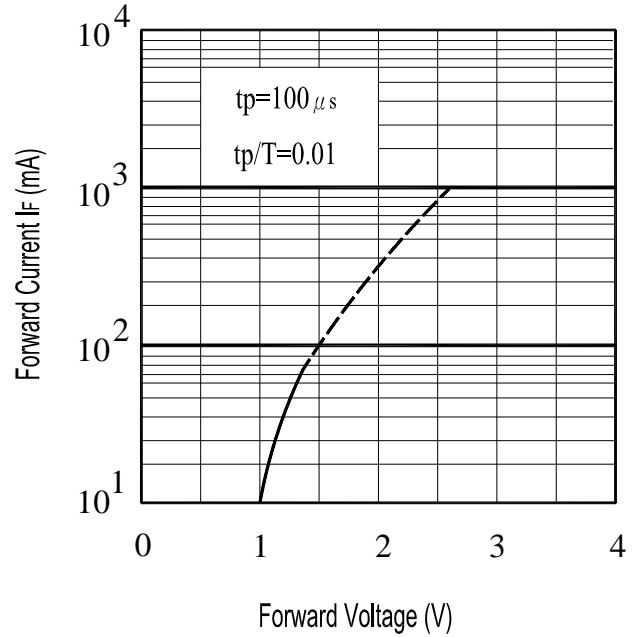

Fig.4 Forward Current vs. Forward Voltage



Typical Electro-Optical Characteristics Curves

Fig.5 Relative Intensity vs. Forward Current

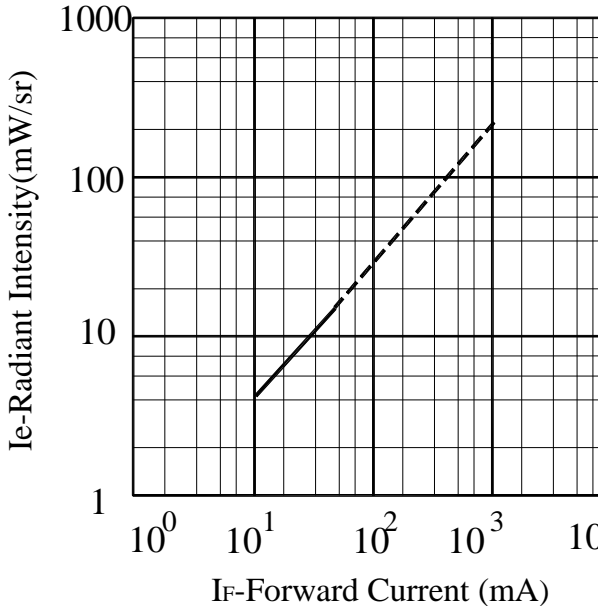
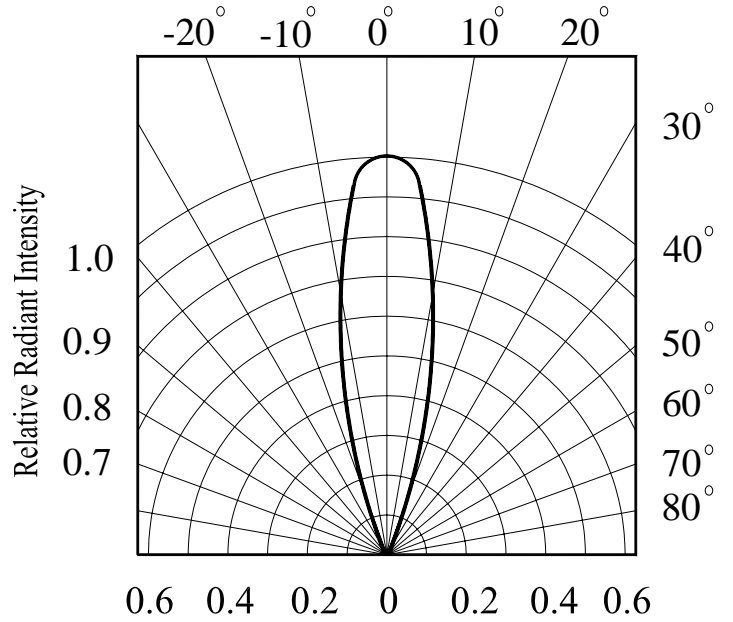
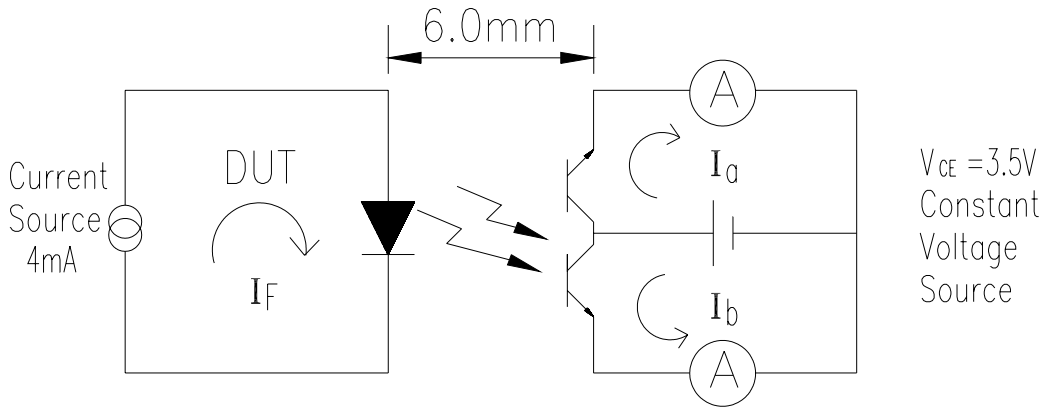

Fig.6 Relative Radiant Intensity vs Angular Displacement



Test Method

The intensity testing method of Infrared emitting diode:



To Distinguish Intensity:

Ranks

Color Code	Parameter	Symbol	Min	Max	Unit	Test Condition
No paint	7-2	I _{c(on)}	300	450	μ A	I _F =4mA, V _{CE} =3.5V
No paint	7-1	I _{c(on)}	330	565	μ A	I _F =4mA, V _{CE} =3.5V
No paint	6-2	I _{c(on)}	450	770	μ A	I _F =4mA, V _{CE} =3.5V
No paint	6-1	I _{c(on)}	630	1300	μ A	I _F =4mA, V _{CE} =3.5V
No paint	5-2	I _{c(on)}	1000	2000	μ A	I _F =4mA, V _{CE} =3.5V

Reliability Test Item And Condition

The reliability of products shall be satisfied with items listed below.

Confidence level : 90%

LTPD : 10%

NO.	Item	Test Conditions	Test Hours/ Cycles	Sample Sizes	Failure Judgment Criteria	Ac/Re
1	Solder Heat	TEMP. : 260°C±5°C	10 secs	22pcs	$I_R \geq U \times 2$ $I_{C(ON)} \leq L \times 0.8$ $V_F \geq U \times 1.2$ U : Upper Specification Limit L : Lower Specification Limit	0/1
2	Temperature Cycle	H : +85°C 30mins ↑ 5mins ↓ L : -55°C 30mins	50 Cycles	22pcs		0/1
3	Thermal Shock	H : +100°C 5mins ↑ 10secs ↓ L : -10°C 5mins	50 Cycles	22pcs		0/1
4	High Temperature Storage	TEMP. : +100°C	1000 hrs	22pcs		0/1
5	Low Temperature Storage	TEMP. : -55°C	1000 hrs	22pcs		0/1
6	DC Operating Life	$I_F = 20\text{mA}$	1000 hrs	22pcs		0/1
7	High Temperature/ High Humidity	85°C / 85% R.H	1000 hrs	22pcs		0/1

EVERLIGHT ELECTRONICS CO., LTD.

Office: No 25, Lane 76, Sec 3, Chung Yang Rd,
Tucheng, Taipei 236, Taiwan, R.O.C

Tel: 886-2-2267-2000, 2267-9936

Fax: 886-2267-6244, 2267-6189, 2267-6306

<http://www.everlight.com>

Device No:DIR-958-142