



T-1 3/4 (5 mm) SOLID STATE LAMPS

HIGH EFF. RED
HIGH EFF. RED

HLMP-3300
HLMP-3301

HIGH EFF. RED
HIGH EFF. RED
STANDARD RED

HLMP-3315
HLMP-3316
FLV110

PACKAGE DIMENSIONS

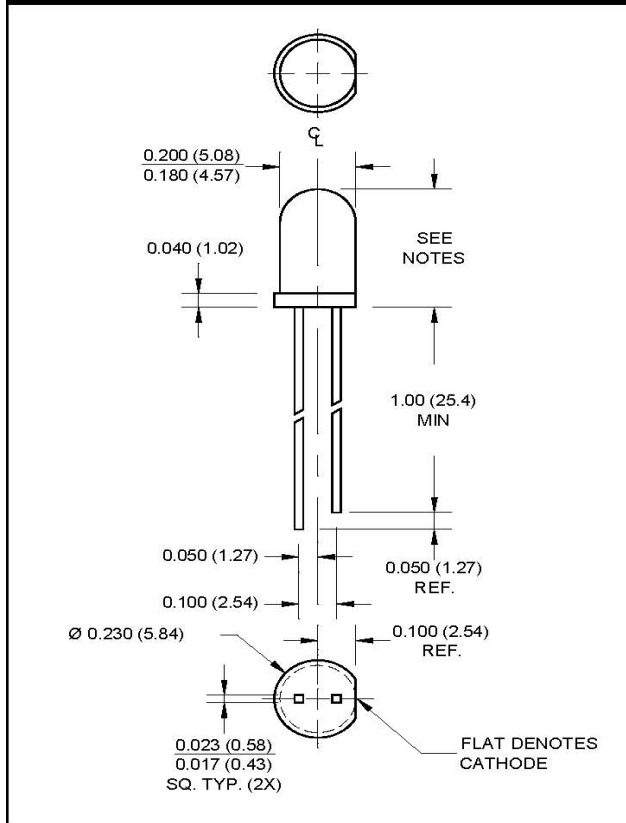

FEATURES

- Popular, general purpose lamps
- Wide and narrow viewing angle devices for direct view or backlighting
- Solid state reliability
- Sturdy leads for easy assembly



DESCRIPTION

The HLMP-33XX series consists of high efficiency red T-1 3/4 lamps with a viewing angle of 35° or 65°. FLV110 is a low profile standard red T-1 3/4 lamp with a diffused lens, providing a viewing angle of 70°.

NOTES:

1. ALL DIMENSIONS ARE IN INCHES (mm).
2. TOLERANCES ARE ± 0.10 " INCH UNLESS SPECIFIED.
3. AN EPOXY MENISCUS MAY EXTEND ABOUT .040" (1 mm) DOWN THE LEADS.
4. DIMENSIONS X.
PACKAGE HEIGHT HLMP = .330 (8.38)/.350 (8.89)
FLV = .275 (6.98)/.295 (7.49)
5. FLV FLANGE HEIGHT = 0.040 (1.02)
0.060 (1.53)

ABSOLUTE MAXIMUM RATING (T_A = 25°C)

Parameter	HLMP33XX	FLV110	UNITS
Power Dissipation	135	135	mW
Average Forward Current	30	30	mA
Peak Forward Current (1 μS pulsewidth, 0.3% duty cycle)(FLV110 1 amp)	90	90	mA
Reverse Voltage	5	5	V
Lead Soldering Time at 260° C	5	5	sec
Operating Temperature	-55 to +100	-55 to +100	°C
Storage Temperature	-55 to +100	-55 to +100	°C



T-1 3/4 (5 mm) SOLID STATE LAMPS

ELECTRICAL / OPTICAL CHARACTERISTICS ($T_A = 25^\circ\text{C}$)						
Part Number	HLMP-3300	HLMP-3301	HLMP-3315	HLMP-3316	FLV110	Condition
Luminous Intensity (mcd)						$I_F = 10\text{mA}$
Minimum	2.0	4.0	12	20	0.8*	
Typical	3.5	7.0	18	35	3.0*	
Forward Voltage (V)						$I_F = 10\text{mA}$
Maximum	3.0	3.0	3.0	3.0	2.0	
Typical	2.2	2.2	2.2	2.2	1.6	
Peak Wavelength (nm)	635	635	635	635	660	$I_F = 10\text{mA}$
Reverse Voltage (V)	5	5	5	5	5	$I_R = 100\mu\text{A}$
Viewing Angle ($^\circ$)	65	65	35	35	70	$I_F = 10\text{mA}$

* For FLV110 Test $I_F = 20\text{mA}$



**T-1 3/4 (5 mm)
SOLID STATE LAMPS**

TYPICAL PERFORMANCE CURVES (T_A = 25°C)

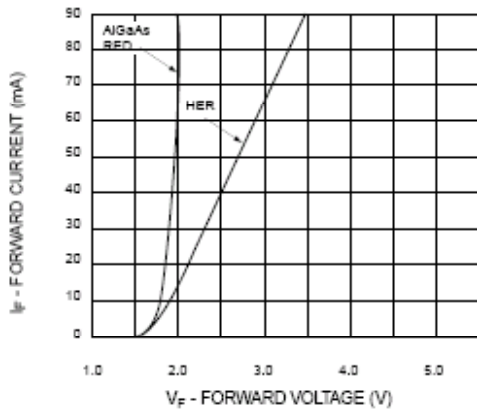

Fig. 1 Forward Current vs. Forward Voltage

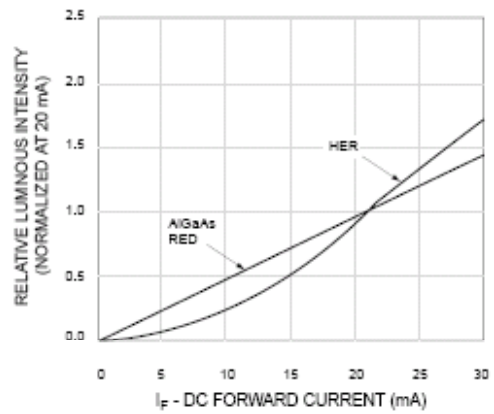

Fig. 2 Relative Luminous Intensity vs. DC Forward Current

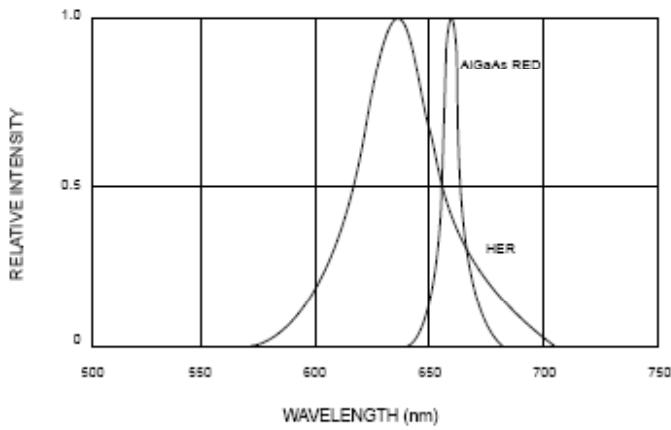

Fig. 3 Relative Intensity vs. Peak Wavelength

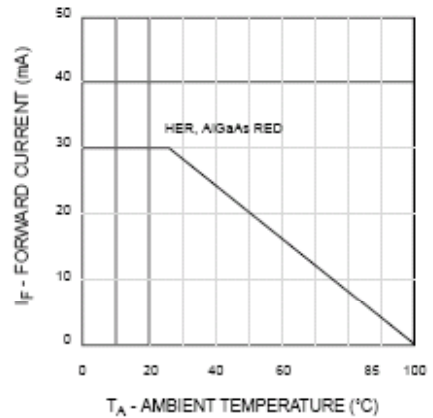

Fig. 4 Current Derating Curve



T-1 3/4 (5 mm) SOLID STATE LAMPS

DISCLAIMER

FAIRCHILD SEMICONDUCTOR RESERVES THE THE RIGHT TO MAKE CHANGES WITHOUT FURTHER NOTICE TO ANY PRODUCTS HEREIN TO IMPROVE RELIABILITY, FUNCTION OR DESIGN. FAIRCHILD DOES NOT ASSUME ANY LIABILITY ARISING OUT OF THE APPLICATION OR USE OF ANY PRODUCT OR CIRCUIT DESCRIBED HEREIN; NEITHER DOES IT CONVEY ANY LICENSE UNDER ITS PATENT RIGHTS, NOR THE RIGHTS OF OTHERS.

LIFE SUPPORT POLICY

FAIRCHILD'S PRODUCTS ARE NOT AUTHORIZED FOR USE AS CRITICAL COMPONENTS IN LIFE SUPPORT DEVICES OR SYSTEMS WITHOUT THE EXPRESS WRITTEN APPROVAL OF THE PRESIDENT OF FAIRCHILD SEMICONDUCTOR CORPORATION. As used herein:

1. Life support devices or systems are devices or systems which, (a) are intended for surgical implant into the body, or (b) support or sustain life, and (c) whose failure to perform when properly used in accordance with instructions for use provided in labeling, can be reasonably expected to result in a significant injury of the user.
2. A critical component in any component of a life support device or system whose failure to perform can be reasonably expected to cause the failure of the life support device or system, or to affect its safety or effectiveness.