



Technical Data Sheet
0.54" Dual Digit Alphanumeric Displays

ELD-526USOWA/S530-A4

■ Features :

- Industrial standard size.
- Low power consumption.
- Categorized for luminous intensity.
- Pb free
- The product itself will remain within RoHS compliant version

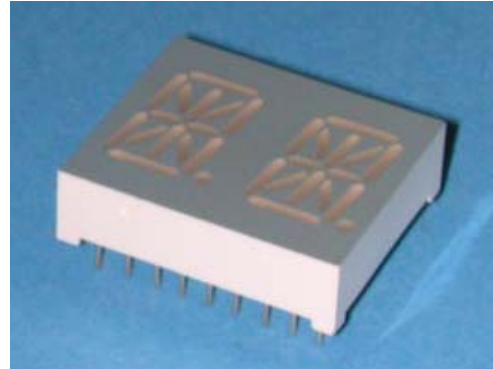

■ Descriptions :

- The ELD-526 series is a large 13.6 mm (0.54")high seven segment display designed for viewing distances up to 7 meters.
- These displays provide excellent reliability in bright ambient light.
- These devices are made with white segments and gray surface.

■ Applications :

- Audio equipment
- Instrument panels
- Digital read out display

PART NO.	Chip	
	Material	Emitted Color
ELD-526USOWA/S530-A4	AlGaInP	Reddish Orange



Technical Data Sheet
0.54" Dual Digit Alphanumeric Displays

ELD-526USOWA/S530-A4

Package Dimensions

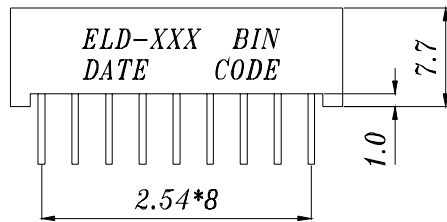
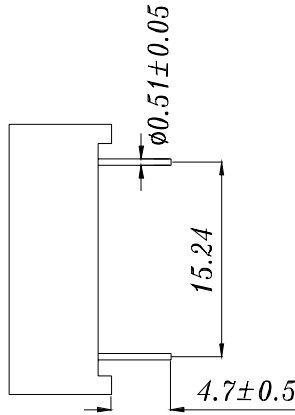
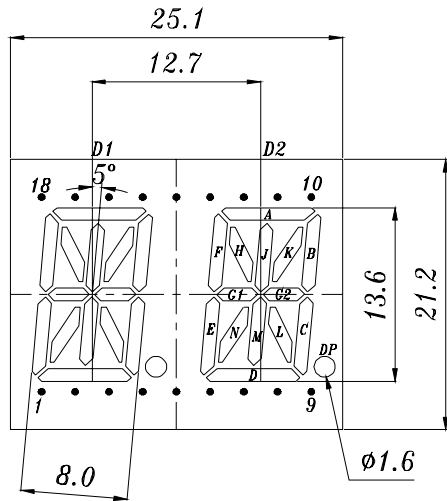

- COMMON ANODE
- 1 CATHODE E
- 2 CATHODE N
- 3 NO CONNECT
- 4 CATHODE M
- 5 CATHODE L
- 6 CATHODE G2
- 7 CATHODE D
- 8 CATHODE DP
- 9 CATHODE C
- 10 CATHODE B
- 11 COMMON ANODE DIG.2
- 12 CATHODE A
- 13 CATHODE G1
- 14 CATHODE K
- 15 CATHODE J
- 16 COMMON ANODE DIG.1
- 17 CATHODE H
- 18 CATHODE F

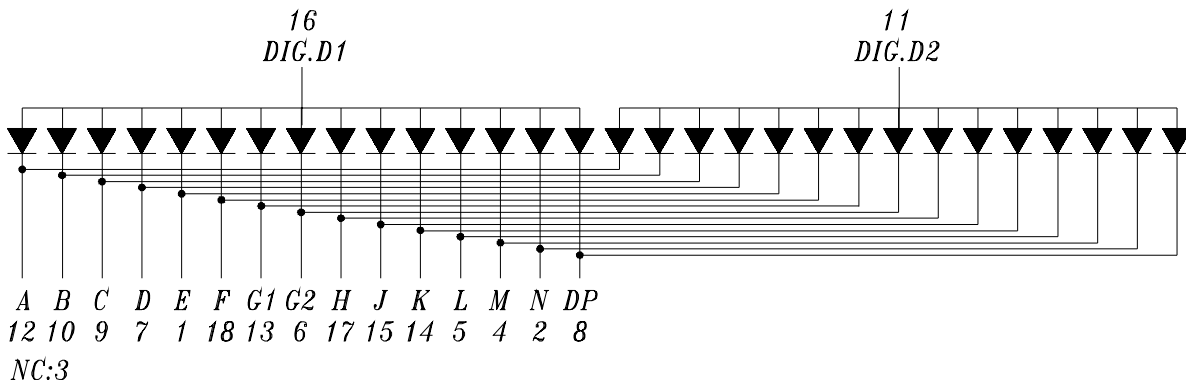

Notes: 1.All dimensions are in millimeters , tolerance is 0.25mm unless otherwise noted.
 2.Above specification may be changed without notice.
 Supplier will reserve authority on material change for above specification.



Technical Data Sheet

0.54" Dual Digit Alphanumeric Displays

ELD-526USOWA/S530-A4

■ Absolute maximum ratings at Ta = 25°C :

Parameter	Symbol	Rating	Unit
Reverse Voltage	VR	5	V
Forward Current	IF	25	mA
Operating Temperature	Topr	-40 to +85	°C
Storage Temperature	Tstg	-40 to +100	°C
Soldering Temperature *	Tsol	260 ± 5	°C
Electrostatic Discharge	ESD	2000	V
Power Dissipation	Pd	60	mW

Note: *Soldering time ≤ 5 seconds.

■ Electronic optical characteristics :

Parameter		Symbol	Min.	Typ.	Max.	Unit	Condition
Luminous Intensity	Per segment	Iv	----	2.5	----	mcd	IF=2mA
			5.6	12.5	----	mcd	IF=10mA
	Per decimal point		----	0.7	----	mcd	IF=2mA
			1.4	3.0	----	mcd	IF=10mA
Peak Wavelength		λ p	----	621	----	nm	IF=20mA
Dominant Wavelength		λ d	----	615	----	nm	IF=20mA
Spectrum Radiation Bandwidth		△ λ	----	18	----	nm	IF=20mA
Forward Voltage		VF	-----	2.0	2.4	V	IF=20mA
Reverse Current		IR	----	----	100	μ A	VR=5V



Technical Data Sheet
0.54" Dual Digit Alphanumeric Displays

ELD-526USOWA/S530-A4

■ Typical Electro-Optical Characteristic Curves:

CHIP Material:AlGaInP
Emitted Color:Reddish Orange

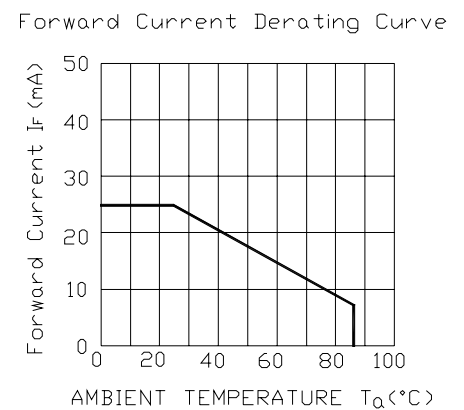
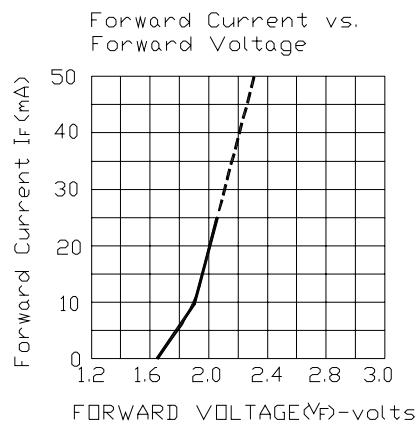
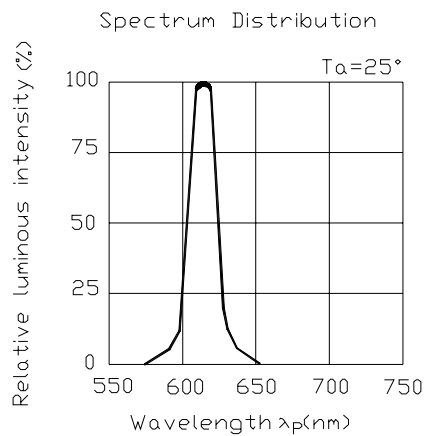



Technical Data Sheet

0.54" Dual Digit Alphanumeric Displays

ELD-526USOWA/S530-A4

■ Reliability test items and conditions:

The reliability of products shall be satisfied with items listed below.

Confidence level : 97%

LTPD : 3%

NO	Item	Test Conditions	Test Hours/Cycle	Sample Size	Failure Judgment Criteria	Ac/Re
1	Solder Heat	TEMP : 260°C ± 5 °C	5 SEC	76 PCS	$I_v \leq I_{vt} * 0.5$ or $V_f \geq U$ or $V_f \leq L$	0/1
2	Temperature Cycle	H : +85°C 30min § 5 min L : -55°C 30min	50 CYCLE	76 PCS		0/1
3	Thermal Shock	H : +100°C 5min § 10 sec L : -10°C 5min	50 CYCLE	76 PCS		0/1
4	High Temperature Storage	TEMP : 100°C	1000 HRS	76 PCS		0/1
5	Low Temperature Storage	TEMP : -55°C	1000 HRS	76 PCS		0/1
6	DC Operating Life	IF = 10 mA	1000 HRS	76 PCS		0/1
7	High Temperature / High Humidity	85°C/85% RH	1000 HRS	76 PCS		0/1

Note : I_{vt} : The test I_v value of the chip before the reliability test

I_v : The test value of the chip that has completed the reliability test

U : Upper Specification Limit

L : Lower Specification Limit



Technical Data Sheet
0.54" Dual Digit Alphanumeric Displays

ELD-526USOWA/S530-A4

■ Packing Quantity Specification

- 1. 20PCS/tube, 36 tubes/box
- 2. 4Boxes/Carton

Label Form Specification

EVERLIGHT

CPN:
P/N:



D526USOWA/S530-A4

QTY:



LOT NO:

MADE IN CHINA

CAT:

HUE:

REF:

CPN: Customer's Production Number

P/N : Production Number

QTY: Packing Quantity

CAT: Ranks

HUE: Dominant Wavelength

REF: Reference

LOT No: Lot Number

MADE IN CHINA: Production Place

Notes :

- 1. Above specification may be changed without notice. EVERLIGHT will reserve authority on material change for above specification.
- 2. When using this product, please observe the absolute maximum ratings and the instructions for using outlined in these specification sheets. EVERLIGHT assumes no responsibility for any damage resulting from use of the product which does not comply with the absolute maximum ratings and the instructions included in these specification sheets.
- 3. These specification sheets include materials protected under copyright of EVERLIGHT corporation. Please don't reproduce or cause anyone to reproduce them without EVERLIGHT's consent.

EVERLIGHT ELECTRONICS CO., LTD.

Office: 7c Building ,Lian Hua Port Industrial District, Lian Hua Shan
Bonded Processing, Zone Pan Yu, Guang Zhou, China

Tel: (020) 84860913 , 84860914

Fax: (020) 84860600

http://www.everlight.com