



Technical Data Sheet

3mm POWER LED

33-01/Y5C-ARTC

Features

- . High Flux Output.
- . Designed for High Current Operation.
- . Low Thermal Resistance.
- . Low Profile.
- . Packaged in Tubes for Use with Automatic Insertion Equipment.
- . The product itself will remain within RoHS compliant version.

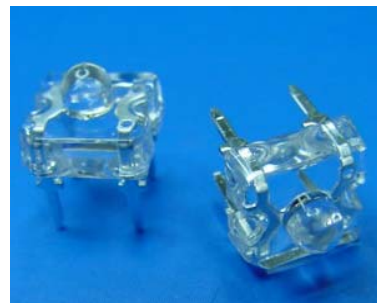

Descriptions

This revolutionary package design allows the light designer to reduce the number of LEDs required and provide a more uniform and unique illuminated appearance than with other LED solutions. This is possible through the efficient optical package design and high-current capabilities.

The low profile package can be easily coupled with reflectors or lenses to efficiently distribute light and provide the desired light appearance.

Applications

- . Automotive Lighting
- . Electronic Signs and Signals
- . Channel Letter
- . Special Lighting application

Device Selection Guide

PART NO.	Chip		Lens Color
	Material	Emitted Color	
33-01/Y5C-ARTC	AlGaInP	Yellow	Water Clear



Technical Data Sheet

3mm POWER LED

33-01/Y5C-ARTC

Package Dimensions

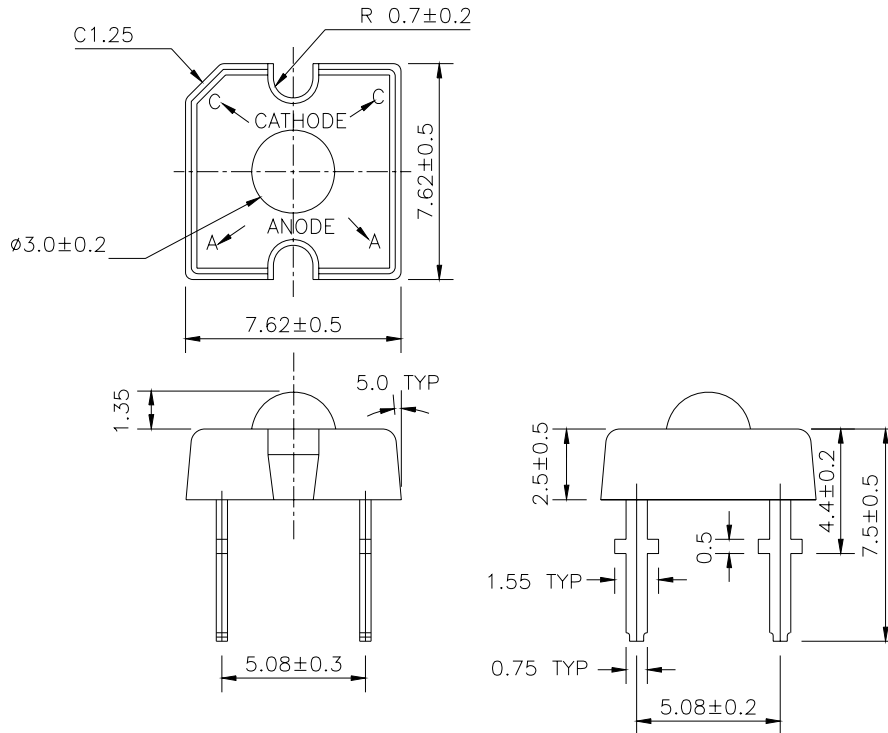

- Notes:**
1. All dimensions are in millimeters
 2. An epoxy meniscus may extend about 1.5mm(0.059") down the leads
 3. Tolerances unless dimensions ±0.25mm

Absolute Maximum Ratings (Ta=25°C)

Parameter	Symbol	Rating	Units
Continuous Forward Current	I _F	70	mA
Peak Forward Current(Duty 1/10 @ 1KHZ)	I _{FP}	160	mA
Operating Temperature	T _{opr}	-40 ~ +100	°C
Storage Temperature	T _{stg}	-40 ~ +100	°C
Soldering Temperature(T=5 sec)	T _{sol}	260 ± 5	°C
LED Junction Temperature	T _j	125	°C
Power Dissipation	P _d	220	mW
Electrostatic Discharge	ESD	2000	V
Reverse Voltage	V _R	5	V



Technical Data Sheet

3mm POWER LED

33-01/Y5C-ARTC

Electro-Optical Characteristics (Ta=25°C)

Parameter	Symbol	Min.	Typ.	Max.	Condition	Unit
Total Flux	Φ_v	4500	6250	9000	I _F =70mA	mlm
Viewing Angle	2θ 1/2	----	100	----	I _F =70mA	deg
Peak Wavelength	λ _p	----	592	----	I _F =70mA	nm
Dominant Wavelength	λ _d	586	590	598	I _F =70mA	nm
Spectrum Radiation Bandwidth	Δλ	----	15	----	I _F =70mA	nm
Forward Voltage	V _F	2.1	2.6	3.1	I _F =70mA	V
Reverse Current	I _R	----	----	10	V _R =5V	μA

Rank

33-01/Y5C-ARTC

(1)

(2)

(3)

(1) V _F (V)			(2) λ _d (nm)			(3) Φ _v (mlm)		
Bin	Min	Max	Bin	Min	Max	Bin	Min	Max
3	2.10	2.30	1	586	590	R	4500	5650
4	2.30	2.50	2	590	594	S	5650	7150
5	2.50	2.70	3	594	598	T	7150	9000
6	2.70	2.90						
7	2.90	3.10						

*Measurement Uncertainty of Forward Voltage : ±0.1V

*Measurement Uncertainty of Luminous Intensity: ±15%

*Measurement Uncertainty of Dominant Wavelength ±1.0nm



Technical Data Sheet

3mm POWER LED

33-01/Y5C-ARTC

Typical Electro-Optical Characteristics Curves

Relative Intensity vs. Wavelength

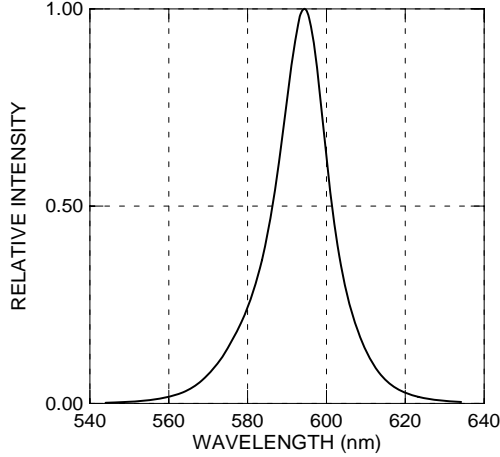

Forward Current vs. Forward Voltage

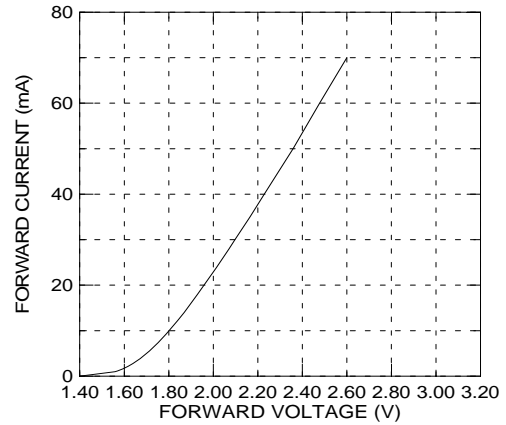

Relative Intensity vs. Forward Current

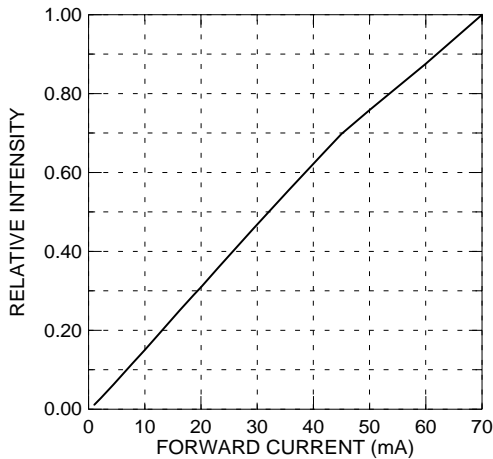

Forward Current vs. Ambient Temp.

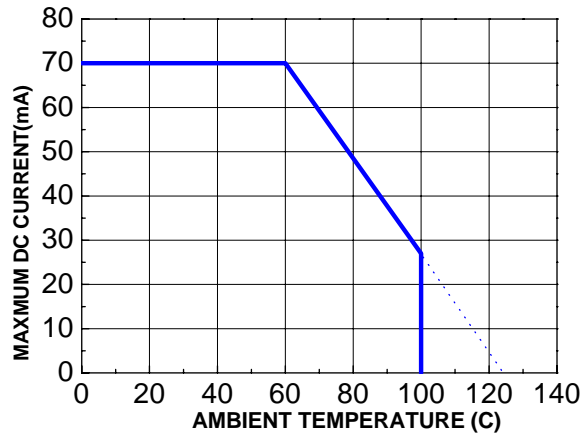

Relative Intensity vs. Angle Displacement

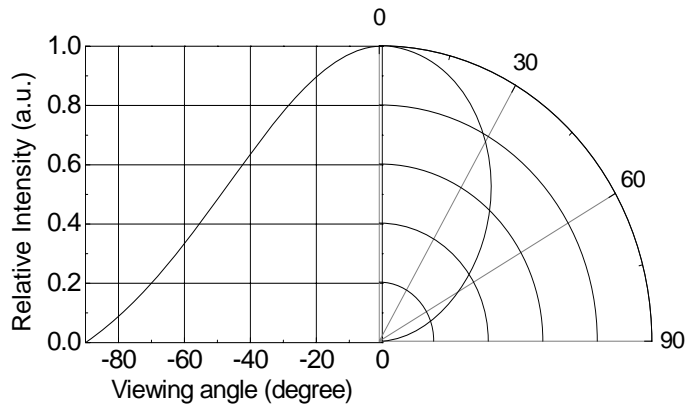



Technical Data Sheet

3mm POWER LED

33-01/Y5C-ARTC

Packing Quantity Specification

- (1) 60 pcs/1 tube, 30 tubes/1 small inside box, 12 small inside boxes/1 outside box
- (2) 60 pcs/1 tube, 105 tubes/1 big inside box, 4 big inside boxes/1 outside box

Label Form Specification

(1)Tube Label Form

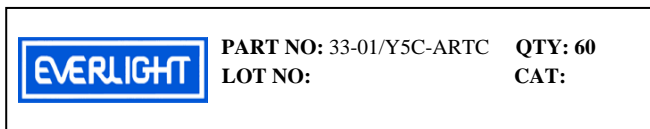

(2)Box Label Form

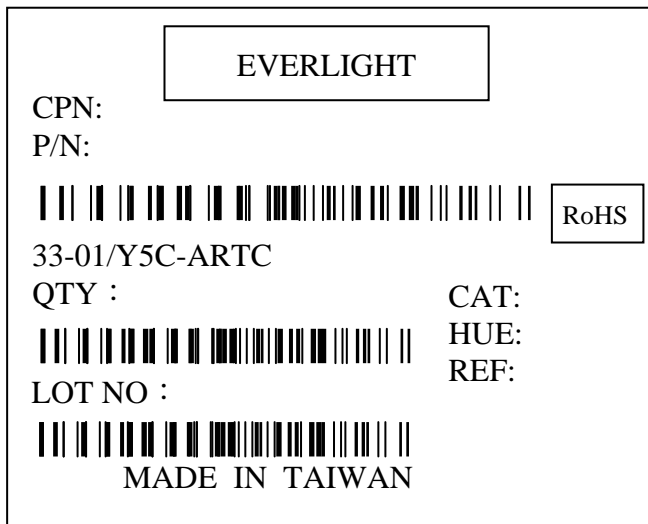

PART NO: Everlight's Production Number

QTY: Packing Quantity

LOT NO: Lot Number

CAT: Ranks of Forward Voltage, Dominant Wavelength and Total Flux

CPN: Customer's Production Number

P/N : Production Number

HUE: Reference

REF: Reference

MADE IN TAIWAN: Production Place



Technical Data Sheet

3mm POWER LED

33-01/Y5C-ARTC

Notes

1. Above specification may be changed without notice. EVERLIGHT will reserve authority on material change for above specification.
2. When using this product, please observe the absolute maximum ratings and the instructions for using outlined in these specification sheets. EVERLIGHT assumes no responsibility for any damage resulting from use of the product which does not comply with the absolute maximum ratings and the instructions included in these specification sheets.
3. These specification sheets include materials protected under copyright of EVERLIGHT corporation. Please don't reproduce or cause anyone to reproduce them without EVERLIGHT's consent.

4. Soldering Condition

Careful attention should be paid during soldering. When soldering, leave more than 3mm from solder joint to case, and soldering beyond the base of the tie bar is recommended.

Avoiding applying any stress to the lead frame while the LEDs are at high temperature particularly when soldering.

Recommended soldering conditions:

Hand Soldering		DIP Soldering	
Temp. at tip of iron	400°C Max. (30W Max.)	Preheat temp.	100°C Max. (60 sec Max.)
Soldering time	3 sec Max.	Bath temp.	265 Max.
Distance	3mm Min. (From solder joint to case)	Bath time.	5 sec Max.
		Distance	3mm Min.

EVERLIGHT ELECTRONICS CO., LTD.
Office: No 25, Lane 76, Sec 3, Chung Yang Rd,
Tucheng, Taipei 236, Taiwan, R.O.C.

Tel: 886-2-2267-2000, 2267-9936
Fax: 886-2267-6244, 2267-6189, 2267-6306
<http://www.everlight.com>