



**S1D13743 Mobile Graphics Engine**

# **S5U13743P00C100 Evaluation Board User Manual**

**Document Number: X70A-G-001-01**

**Status: Revision 1.0**

**Issue Date: 2007/08/15**

## Evaluation Board/Kit and Development Tool Important Notice

---

1. This evaluation board/kit or development tool is designed for use for engineering evaluation, demonstration, or development purposes only. Do not use it for other purposes. It is not intended to meet the requirements of design for finished products.
2. This evaluation board/kit or development tool is intended for use by an electronics engineer and is not a consumer product. The user should use it properly and in a safe manner. Seiko Epson does not assume any responsibility or liability of any kind of damage and/or fire caused by the use of it. The user should cease to use it when any abnormal issue occurs even during proper and safe use.
3. The part used for this evaluation board/kit or development tool may be changed without any notice.

## NOTICE

---

No part of this material may be reproduced or duplicated in any form or by any means without the written permission of Seiko Epson. Seiko Epson reserves the right to make changes to this material without notice. Seiko Epson does not assume any liability of any kind arising out of any inaccuracies contained in this material or due to its application or use in any product or circuit and, further, there is no representation that this material is applicable to products requiring high level reliability, such as, medical products. Moreover, no license to any intellectual property rights is granted by implication or otherwise, and there is no representation or warranty that anything made in accordance with this material will be free from any patent or copyright infringement of a third party. When exporting the products or technology described in this material, you should comply with the applicable export control laws and regulations and follow the procedures required by such laws and regulations. You are requested not to use, to resell, to export and/or to otherwise dispose of the products (and any technical information furnished, if any) for the development and/or manufacture of weapon of mass destruction or for other military purposes.

All brands or product names mentioned herein are trademarks and/or registered trademarks of their respective companies.

©SEIKO EPSON CORPORATION 2007 - 2012, All rights reserved.

# Table of Contents

<b>1</b>	<b>Introduction</b>	<b>5</b>
<b>2</b>	<b>Features</b>	<b>6</b>
<b>3</b>	<b>Installation and Configuration</b>	<b>7</b>
3.1	Configuration DIP Switch	.7
3.2	Configuration Jumpers	.8
<b>4</b>	<b>Technical Description</b>	<b>12</b>
4.1	Power	12
4.1.1	Power Requirements	12
4.1.2	Voltage Regulators	12
4.1.3	S1D13743 Power	12
4.2	Clocks	13
4.3	Reset	13
4.4	Power Save	13
4.5	Host Interface	14
4.5.1	Direct Host Bus Interface Support	14
4.5.2	Connecting to the Epson S5U13U00P00C100 USB Adapter Board	15
4.6	LCD Panel Interface	16
4.7	GPIO Connections	17
<b>5</b>	<b>Parts List</b>	<b>18</b>
<b>6</b>	<b>Schematic Diagrams</b>	<b>21</b>
<b>7</b>	<b>Board Layout</b>	<b>24</b>
<b>8</b>	<b>References</b>	<b>26</b>
8.1	Documents	26
8.2	Document Sources	26
<b>9</b>	<b>Technical Support</b>	<b>27</b>
9.1	EPSON Display Controllers (S1D13743)	27
9.2	Ordering Information	27



---

# 1 Introduction

This manual describes the setup and operation of the S5U13743P00C100 Evaluation Board. The evaluation board is designed as an evaluation platform for the S1D13743 Mobile Graphics Engine.

The S5U13743P00C100 evaluation board can be used with many native platforms via the host connector which provides the appropriate signals to support a variety of CPUs. The S5U13743P00C100 evaluation board can also connect to the S5U13U00P00C100 USB Adapter board so that it can be used with a laptop or desktop computer, via USB 2.0.

This user manual is updated as appropriate. Please check the Epson Research and Development Website at [www.erd.epson.com](http://www.erd.epson.com) for the latest revision of this document before beginning any development.

We appreciate your comments on our documentation. Please contact us via email at [documentation@erd.epson.com](mailto:documentation@erd.epson.com).

## 2 Features

The S5U13743P00C100 Evaluation Board includes the following features:

- 121-pin FCBGA S1D13743 Mobile Graphics Engine
- Header with all S1D13743 Host Bus Interface signals
- Headers for connection to the S5U13U00P00C100 USB Adapter board
- Headers for connecting to LCD panels
- Header for S1D13743 GPIO pins (optional)
- On-board 4MHz oscillator
- 14-pin DIP socket (if a clock other than 4MHz must be used)
- 3.3V input power
- On-board voltage regulator with 1.5V output
- On-board voltage regulator with adjustable 6~24V output, 40mA max., to provide power for LED backlight of LCD panels.

### 3 Installation and Configuration

The S5U13743P00C100 evaluation board incorporates a DIP switch, jumpers, and 0 ohm resistors which allow it to be used with a variety of different configurations.

#### 3.1 Configuration DIP Switch

The S1D13743 has 3 configuration inputs (CNF[2:0]). A DIP switch (SW1) is used to configure CNF[2:0] as described below.

Table 3-1: Summary of Power-On/Reset Options

SDU13743P00C100 SW1-[4:1] Config	S1D13743 CNF[2:0] Config	Power-On/Reset State	
		1 (ON)	0 (OFF)
SW1-[1]	CNF0	Host Data lines are normal	Host data lines are swapped
SW1-[2]	CNF1	Host Data is 16-bit	Host data is 8-bit
SW1-[3]	CNF2	PIOVDD output current = 6.5mA	PIOVDD output current = 2.5mA
SW1-[4]	-	not used	

= Required settings when using S5U13U00P00C100 USB Adapter board

The following figure shows the location of DIP switch SW1 on the S5U13743P00C100 board.

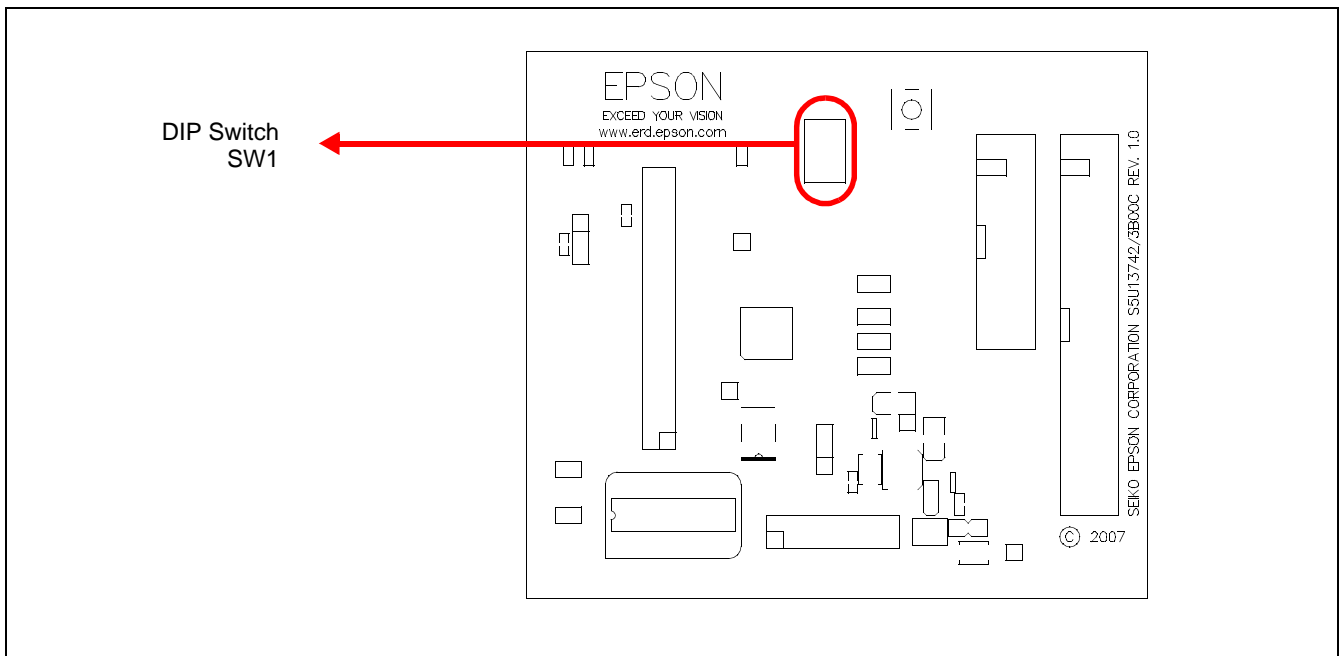
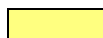

Figure 3-1: Configuration DIP Switch (SW1) Location

## 3.2 Configuration Jumpers

The S5U13743P00C100 has 6 jumpers which configure various board settings. The jumper positions for each function are shown below.

Jumper	Function	Position 1-2	Position 2-3	No Jumper
JP1	COREVDD	Normal	—	COREVDD current measurement
JP2	PLLVD	Normal	—	PLLVD current measurement
JP3	IOVDD	Normal	—	IOVDD current measurement
JP4	IOVDD Source	H1 connector, pin 32	3.3VDD	—
JP5	PIOVDD	Normal	—	PIOVDD current measurement
JP6	PIOVDD Source	H4 connector, pin 8	3.3VDD	—

 = Required settings when using S5U13U00P00C100 USB Adapter board



### JP1, JP2, JP3, JP5 - Power Supplies for the S1D13743

JP1, JP2, JP3, JP5 can be used to measure the current consumption of each S1D13743 power supply.

When the jumper is at position 1-2, normal operation is selected.

When no jumper is installed, the current consumption for each power supply can be measured by connecting an ammeter to pin 1 and 2 of the jumper.

The jumper associated with each power supply is as follows:

JP1 for COREVDD

JP2 for PLLVDD

JP3 for IOVDD

JP5 for PIOVDD

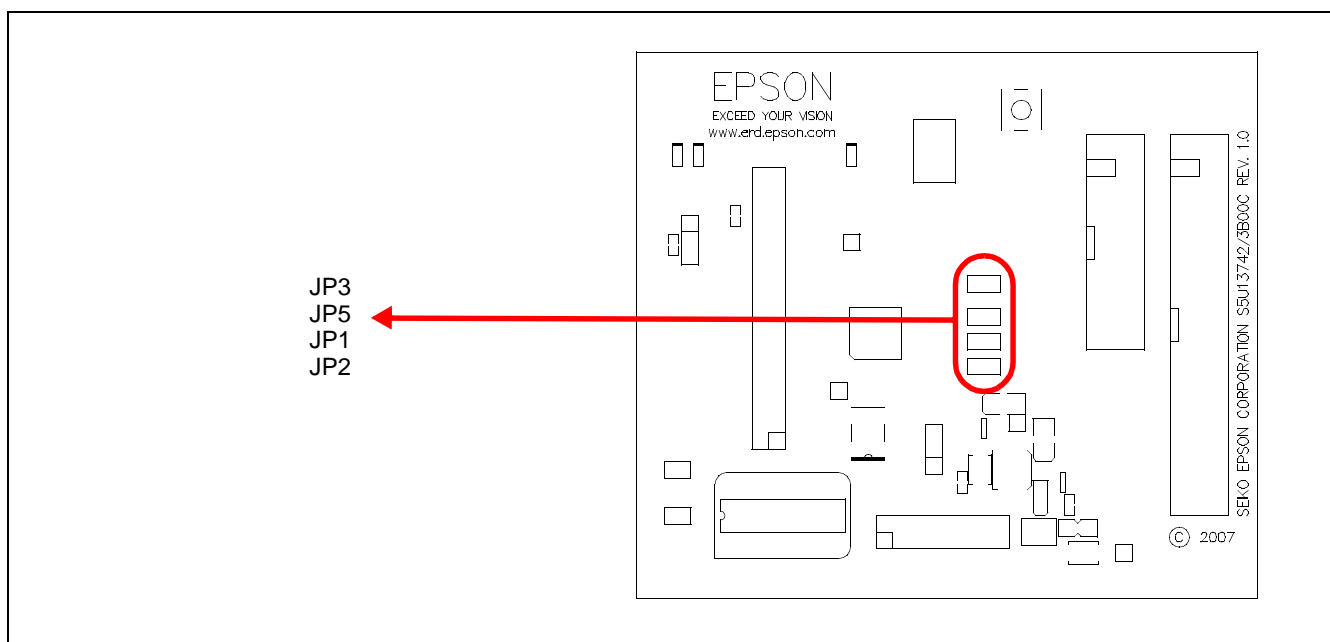

Figure 3-2: Configuration Jumper Locations (JP1, JP2, JP3, JP5)

### JP4 - IOVDD Source

JP4 is used to select the source for the IOVDD supply voltage.

When the jumper is at position 1-2, the IOVDD voltage must be provided to the H1 connector, pin 32.

When the jumper is at position 2-3, the IOVDD voltage is provided by the 3.3V power supply of the board.

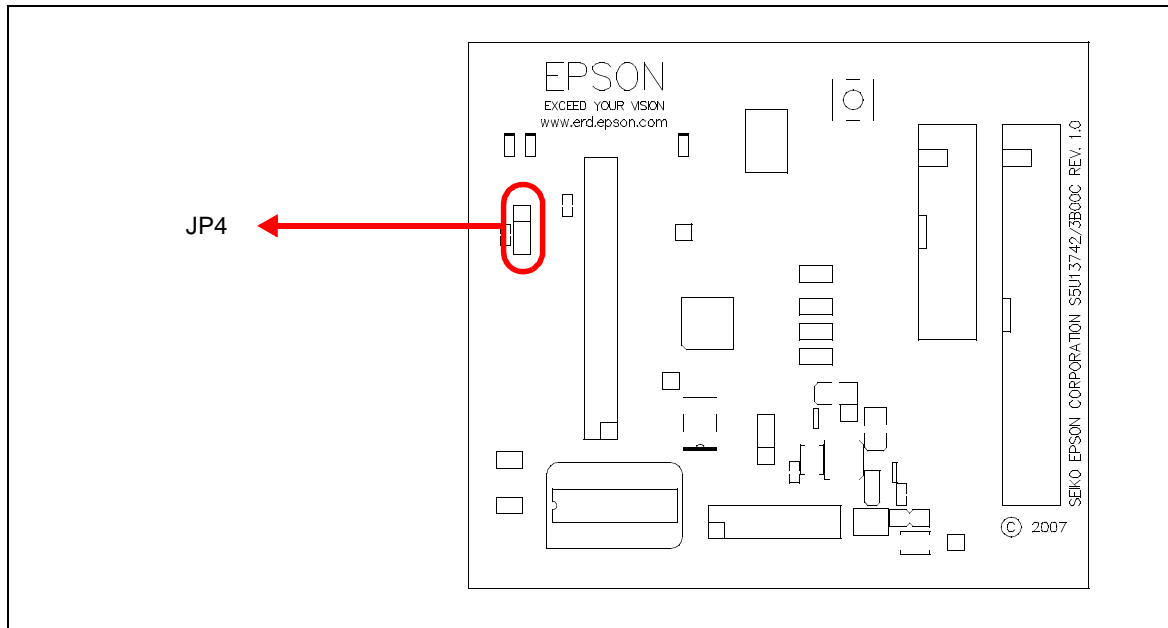

*Figure 3-3: Configuration Jumper Location (JP4)*

### JP6 - SIOVDD Source

JP6 is used to select the source for the PIOVDD supply voltage.

When the jumper is at position 1-2, the PIOVDD voltage must be provided to the H4 connector, pin 8.

When the jumper is at position 2-3, the PIOVDD voltage is provided by the 3.3V power supply of the board.

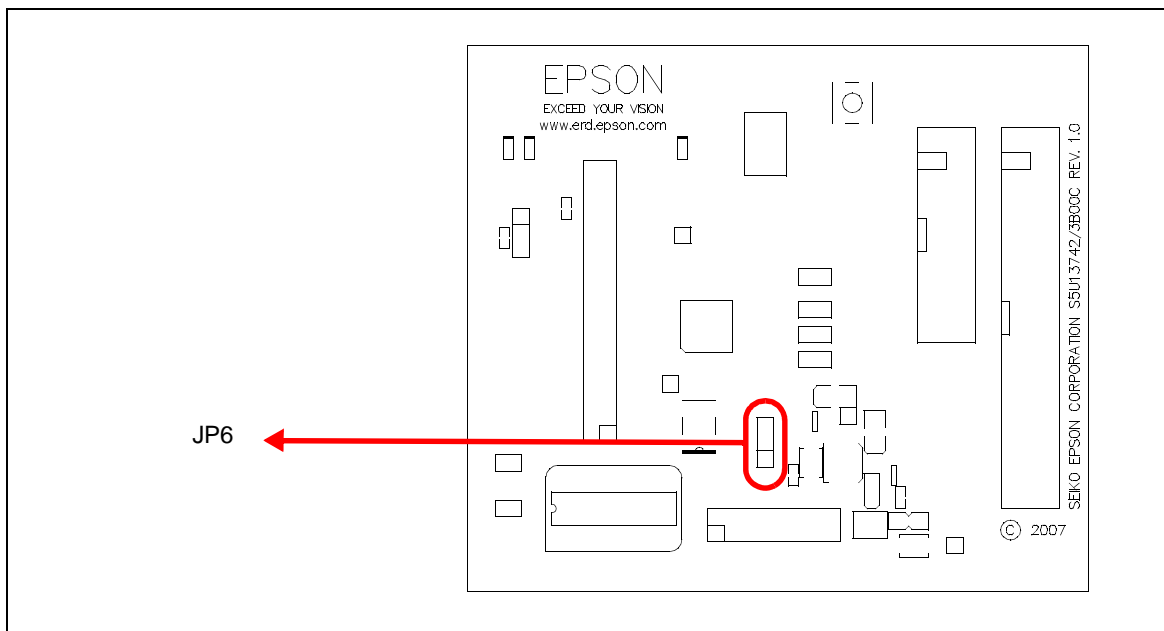

Figure 3-4: Configuration Jumper Location (JP6)

## 4 Technical Description

### 4.1 Power

#### 4.1.1 Power Requirements

The S5U13743P00C100 evaluation board requires an external regulated power supply (3.3V / 0.5A). The power is supplied to the evaluation board through pin 34 of the H1 header, or pin 5 of the P2 header.

The green LED '3.3V Power' is turned on when 3.3V power is applied to the board.

#### 4.1.2 Voltage Regulators

The S5U13743P00C100 evaluation board has an on-board linear regulator to provide the 1.5V power required by the S1D13743 Mobile Graphics Engine. It also has a step-up switching voltage regulator to generate adjustable 6~24V, which can be used to power the LED backlight on some LCD panels.

#### 4.1.3 S1D13743 Power

The S1D13743 Mobile Graphics Engine requires 1.5V and 1.65~3.6V power supplies.

1.5V power for COREVDD and PLLVDD is provided by an on-board linear voltage regulator.

IOVDD can be in the range of 1.65~3.6V. When JP4 is set to the 2-3 position, IOVDD is connected to 3.3V. If a different voltage is required for IOVDD, set JP4 to the 1-2 position and connect the external power supply to pin 32 of connector H1.

##### **Note**

If the IOVDD voltage is less than 3.0V, an oscillator working at the selected IOVDD voltage must be used.

PIOVDD is the power used by the LCD interface and can be in the range of 1.65~3.6V. When JP6 is set to the 2-3 position, PIOVDD is connected to 3.3V. If a different voltage is needed for PIOVDD because of the LCD panel requirements, set JP6 to the 1-2 position and connect the external power supply to pin 8 of connector H4.

## 4.2 Clocks

The clock for the S1D13743 Mobile Graphics Engine is provided by a 4MHz oscillator.

The S5U13743P00C100 evaluation board has a DIP14 footprint for an optional second oscillator, Y2. This is provided for cases requiring a different clock frequency for the S1D13743 Mobile Graphics Engine. To use Y2, an oscillator must be populated in the Y2 footprint and the following board modifications must be made.

1. Remove R10 (33 ohm resistor, size 0402) to cut the output of Y1.
2. Populate R13 with a 33 ohm resistor, size 0402, to connect the output of Y2 to the CLKI input of the S1D13743 Mobile Graphics Engine.

### Note

If the board is configured for an IOVDD voltage below 3.0V, an oscillator working at the selected IOVDD voltage must be used at Y2. The on-board 4MHz oscillator is not specified to work below a 3.0V supply voltage.

The S1D13743 MGE can output the input clock on the CLKOUT pin depending on the state of the CLKOUTEN input. Both these signals are available on the H4 connector: CLKOUT on pin 1 and CLKOUTEN on pin 4. On the board the CLKOUTEN pin is pulled down which disables the CLKOUT signal. Note that connector H4 is not populated on the S5U13743P00C100 evaluation board.

## 4.3 Reset

The S1D13743 Mobile Graphics Engine on the S5U13743P00C100 evaluation board can be reset using a push-button (SW2), or via an active low reset signal from the host development platform (pin 33 on the H1 connector).

## 4.4 Power Save

The S1D13743 chip has an input called PWRSVE that will enable (when high) or disable (when low) the power save mode. This signal is available on pin 5 of the H4 connector. On the board the PWRSVE pin is pulled down which means power save mode is controlled only by the S1D13743 register setting. Note that connector H4 is not populated on the S5U13743P00C100 evaluation board.

## 4.5 Host Interface

### 4.5.1 Direct Host Bus Interface Support

All S1D13743 host interface pins are available on connector H1 which allows the S5U13743P00C100 evaluation board to be connected to a variety of development platforms. For detailed S1D13743 pin mapping, refer to the *S1D13743 Hardware Functional Specification*, document number X70A-A-001-xx.

The following figure shows the location of host bus connector H1. H1 is a 0.1x0.1” 34-pin header (17x2).

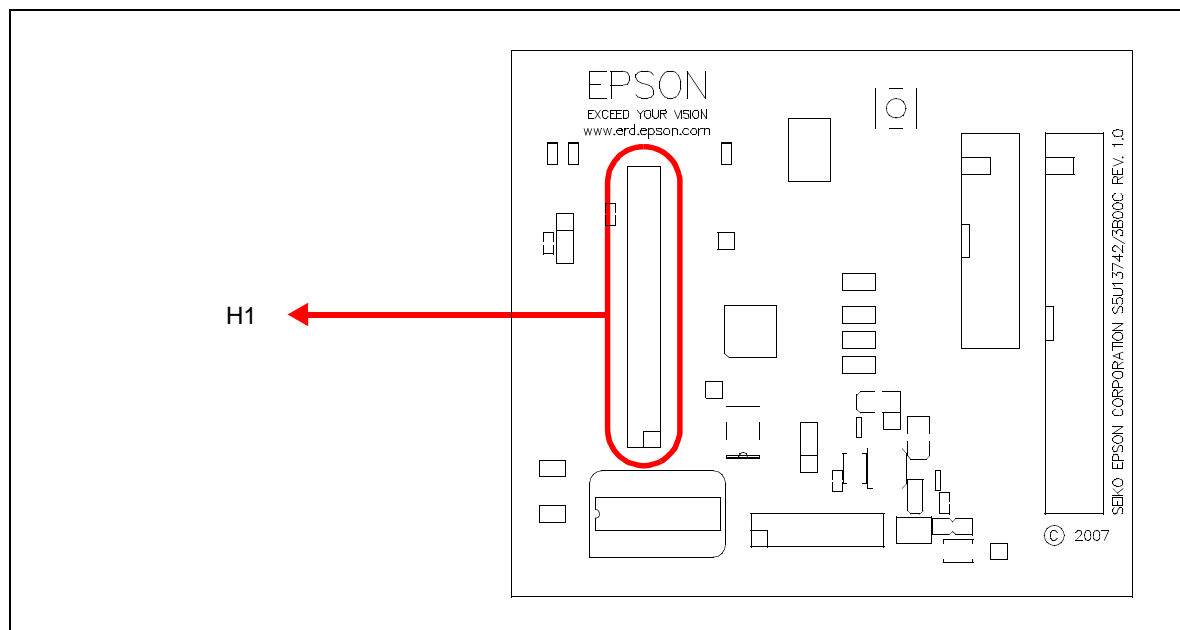

Figure 4-1: Host Bus Connector Location (H1)

For the pinout of connector H1, see “Schematic Diagrams” on page 21.

## 4.5.2 Connecting to the Epson S5U13U00P00C100 USB Adapter Board

The S5U13743P00C100 evaluation board is designed to connect to a S5U13U00P00C100 USB Adapter Board. The USB adapter board provides a simple connection to any computer via a USB 2.0 connection. The S5U13743P00C100 directly connects to the USB adapter board through connectors P1 and P2.

The USB adapter board also supplies the 3.3V power required by the S5U13743P00C100. IOVDD should be selected for 3.3V and JP4 should be set to the 2-3 position.

When the S5U13743P00C100 is connected to the S5U13U00P00C100 USB Adapter board, there are 2 LEDs on S5U13743P00C100 which provide a quick visual status of the USB adapter. LED1 blinks to indicate that the USB adapter board is active. LED2 turns on to indicate that the USB has been enumerated by the PC.

The following diagram shows the location of connectors P1 and P2. P1 and P2 are 40-pin headers (20x2).

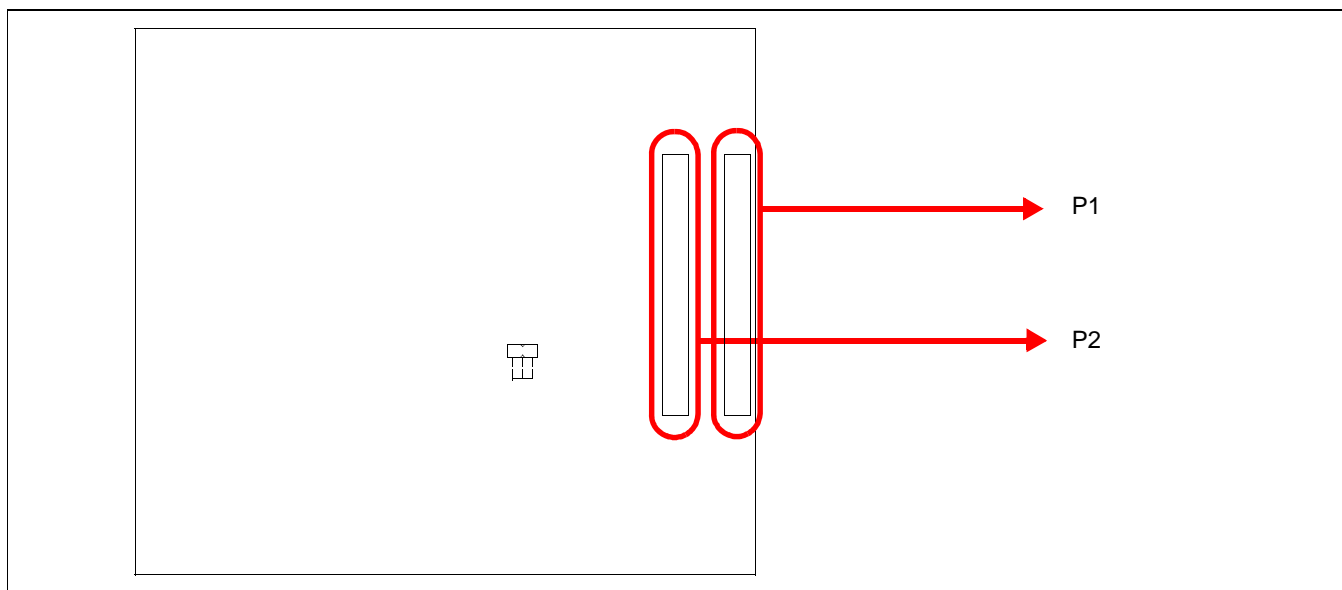

*Figure 4-2: USB Adapter Connector Locations (P1 and P2)*

For the pinout of connectors P1 and P2, see “Schematic Diagrams” on page 21.

### Note

A windows driver must be installed on the PC when the S5U13743P00C100 is used with the S5U13U00P00C100 USB Adapter Board. The S1D13xxxUSB driver is available at [www.erd.epson.com](http://www.erd.epson.com).

## 4.6 LCD Panel Interface

The LCD interface signals are available on connectors H2 and H3. For S1D13743 LCD interface pin mapping, refer to the *S1D13743 Hardware Functional Specification*, document number X70A-A-001-xx.

Connector H2 is 0.1x0.1" 20-pin header (10x2) and connector H3 is 0.1x0.1" 40-pin header (20x2). For the pinout of connectors H2 and H3, see "Schematic Diagrams" on page 21.

On the evaluation board there is an adjustable 6~24V, 40mA max. power supply. This voltage is provided only on connector H3 (it is not used elsewhere on the board). It is intended for use to power the LED backlight on some LCD panels. The voltage is adjusted by the R24 pot.

### Note

For LCD panels that use a CCFL backlight, an external power supply must be used to provide power to the inverter for the CCFL backlight. Usually, the inverter current consumption is higher than the maximum 40mA current available from the on-board voltage regulator.

The following diagram shows the location of the LCD panel connectors H2 and H3.

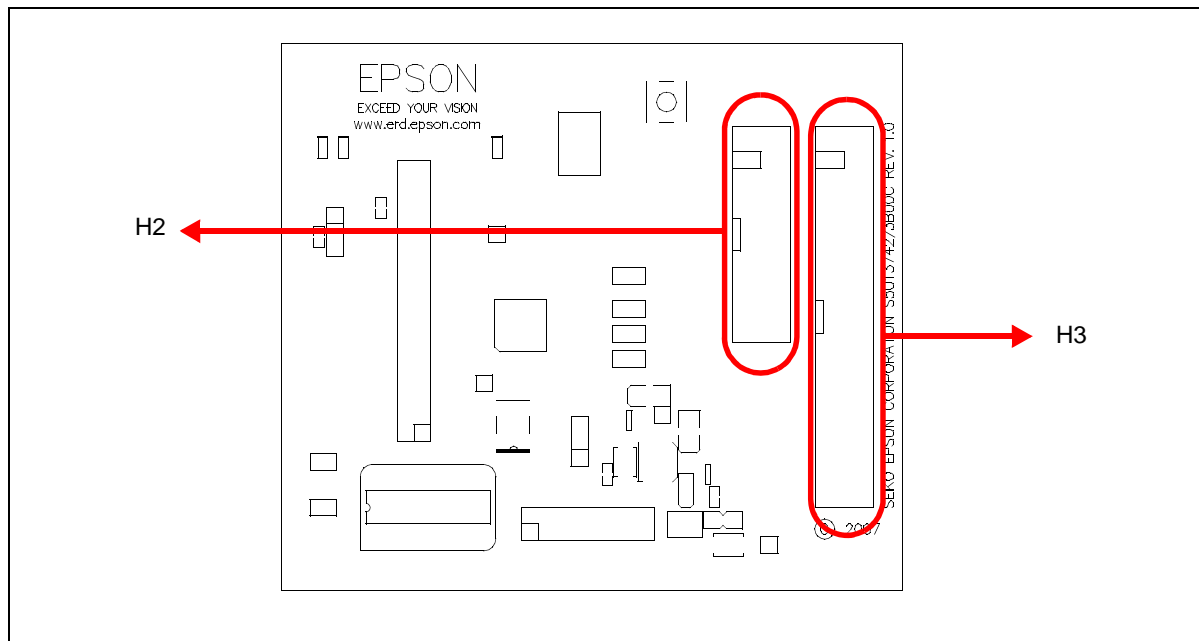

Figure 4-3: LCD Panel Connectors Location (H2, H3)

For the pinout of connectors H2 and H3, see "Schematic Diagrams" on page 21.



## 4.7 GPIO Connections

The S1D13743 Mobile Graphics Engine has 8 GPIO pins. All the GPIO pins are routed to the H4 connector. Note that connector H4 is not populated on the S5U13743P00C100 evaluation board.

The following figure shows the location of the GPIO connector, H4.

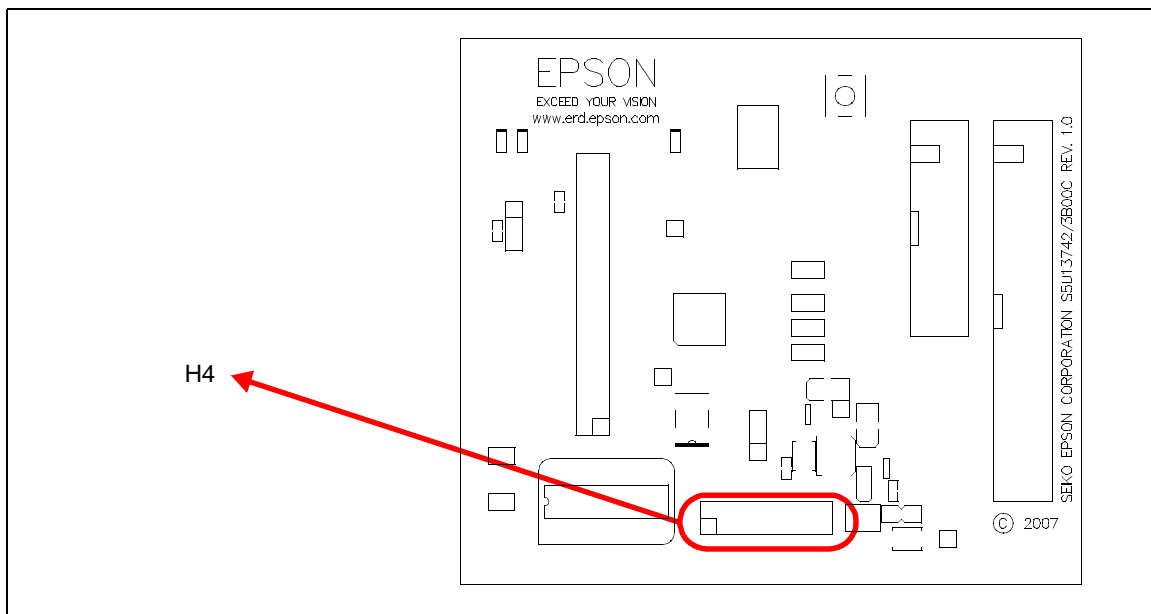

*Figure 4-4: GPIO Connector Location (H4)*

For the pinout of connector H4, see “Schematic Diagrams” on page 21.

## 5 Parts List

Table 5-1: Parts List

Item	Qty	Reference	Part	Description	Mfg / Mfg PN / Notes
1	16	C1, C2, C3, C4, C9, C12, C13, C14, C18, C19, C20, C21, C26, C27, C28, C30, C32	0.1uF	C0402	Yageo America 04022F104Z7B20D
2	12	C5, C6, C7, C8, C15, C16, C17, C22, C23, C24, C25,	0.01uF	C0402	Yageo America 0402ZRY5V7BB103
3	1	C10	1nF	C0402	Yageo America 04022R102K9B20D
4	1	C11	10uF	C0805	Panasonic - ECG ECJ-CV50J106M
5	1	C29	100uF 4V T	C3528	Kemet T494B107M004AS
6	2	C31, C33	0.01uF	C0402	Kemet C0402C103K4RACTU
7	1	C34	4.7uF 10V T	C3528	Kemet T491B475K010AS
8	1	C35	10pF	C0402	Panasonic - ECG ECJ-0EC1H100D
9	1	C36	1uF 50V	C1206	TDK C3216X7R1H105K
10	3	D1, D2, D3		LED0603	Panasonic - SSG LNJ308G8LRA  LED GREEN SS TYPE LOW CUR SMD
11	1	D4	MBR0530	SOD-123	Micro Commercial Co. MBR0530-TP
12	2	F1, F2	ACF451832-222		TDK ACF451832-222  FILTER 3-TERM 60MHZ 300MA SMD
13	1	H1	HEADER_17X2		AMP 1-87215-7
14	1	H2	Extended LCD Connector		Samtec TST-110-01-G-D
15	1	H3	LCD Connector		Samtec TST-120-01-G-D
16	0	H4	HEADER 8X2		Samtec TSW-108-07-G-D
17	4	JP1, JP2, JP3, JP5		SIP2	CONN HEADER VERT 2POS .100 TIN or GENERIC
18	2	JP4, JP6		SIP3	CONN HEADER VERT 3POS .100 TIN or GENERIC
19	2	L1, L2	Ferrite	R0603	Steward HZ0603B751R-10  FERRITE 200MA 938 OHMS 0603 SMD

Table 5-1: Parts List

Item	Qty	Reference	Part	Description	Mfg / Mfg PN / Notes
20	1	L3	10uH	IND_ELL6	Panasonic - ECG ELL-6SH100M  COIL 10UH 1300MA CHOKE SMD
21	2	P1, P2	HEADER_20X2	HDR2X20/2MM	3M 151240-8422-RB
22	3	R1, R2, R3	10k	R0402	
23	3	R4, R7, R19	0	R0603	
24	1	R5	150k 1%	R0402	
25	5	R6, R8, R9, R11, R20	0	R0402	
26	1	R10	33 1%	R0402	
27	0	R12, R13	NP	R0402	
28	3	R14, R15, R16	270 1%	R0402	
29	3	R17, R18, R23	47k	R0402	
30	1	R21	887k 1%	RC0603	
31	1	R22	22k	R0402	
32	1	R24	200k		Panasonic - ECG EVN-5ESX50B25
33	6	SH1, SH2, SH3, SH4, SH5, SH6	.100 in. Jumper Shunt	Not Applicable	Sullins Electronics Corp. STC02SYAN  JUMPER SHORTING TIN
34	1	SW1	SW4_DIPSW4	DIPSW4	CTS Corp 218-4LPST  SWITCH DIP HALF PITCH 4POS
35	1	SW2	SW TACT-SPST	SW_EVQQW	ITT Industries KSC241GLFS  SWITCH TACT SILVER PLT GULLWING
36	2	TPGND1, TP3.3VDD1	TP_SMT	TP_1206	Keystone 5015  PC TEST POINT MINIATURE SMT
37	0	TP1, TP2, TP3, TP4	T POINT F	SIP1	
38	1	U1	S1D13743		

Table 5-1: Parts List

Item	Qty	Reference	Part	Description	Mfg / Mfg PN / Notes
39	1	U2	TPS76915DBVT	SOT23-5	Texas Instruments TPS76915DBVT IC 1.5V 100MA LDO REG SOT-23-5
40	1	U3	TPS61040	SOT23-5	TI TPS61040DVBR IC CONV DC/DC BOOST LP SOT-23-5
41	1	Y1	4M OSC		Connor-Winfield CWX823-4.0M OSC 4.0000MHz 3.3V 50ppm SMD
42	0	Y2	14-Pin DIP		AMP 2-641609-1

# 6 Schematic Diagrams

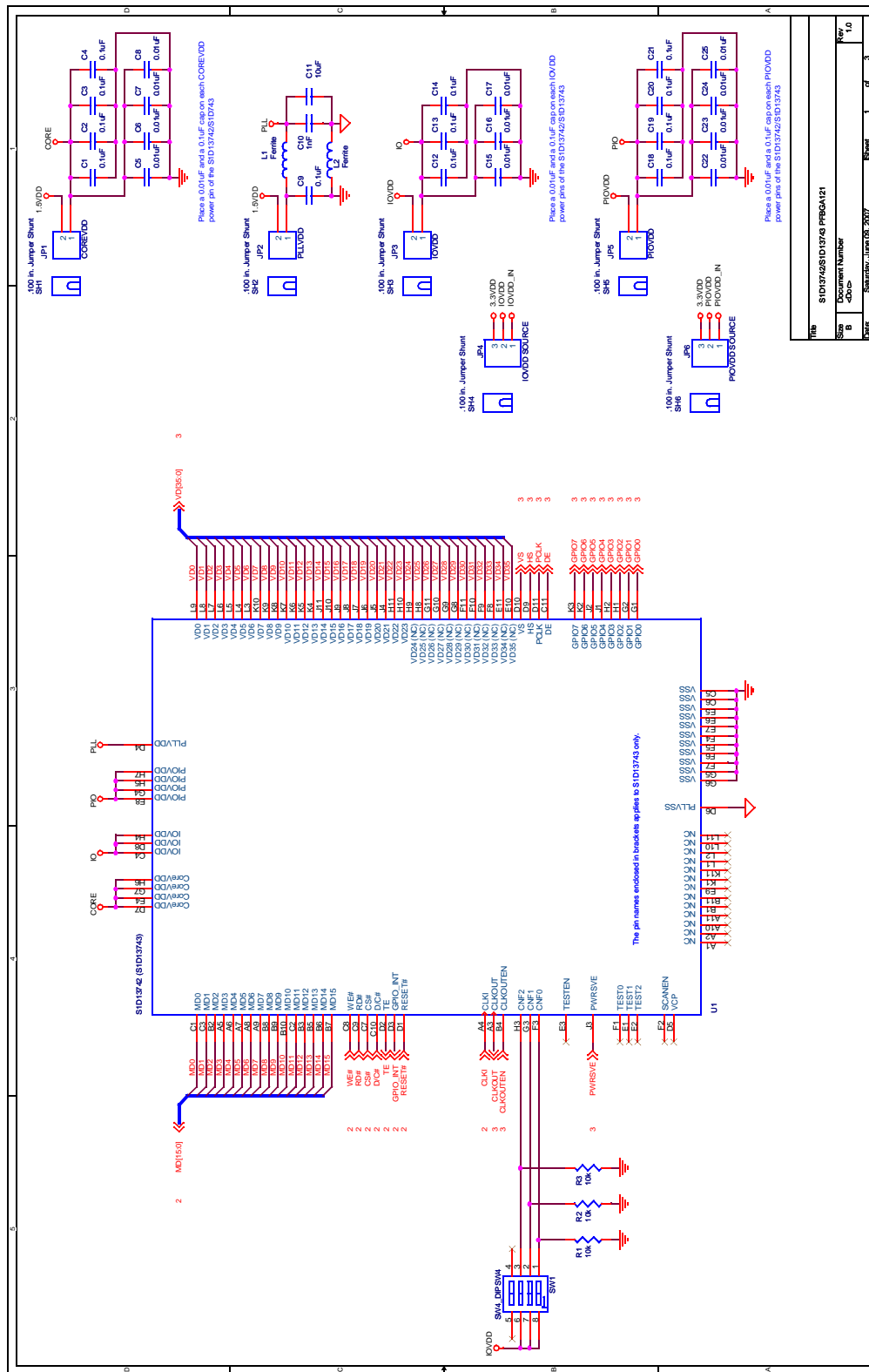

Figure 6-1: S5U13743P00C100 Schematics (1 of 3)

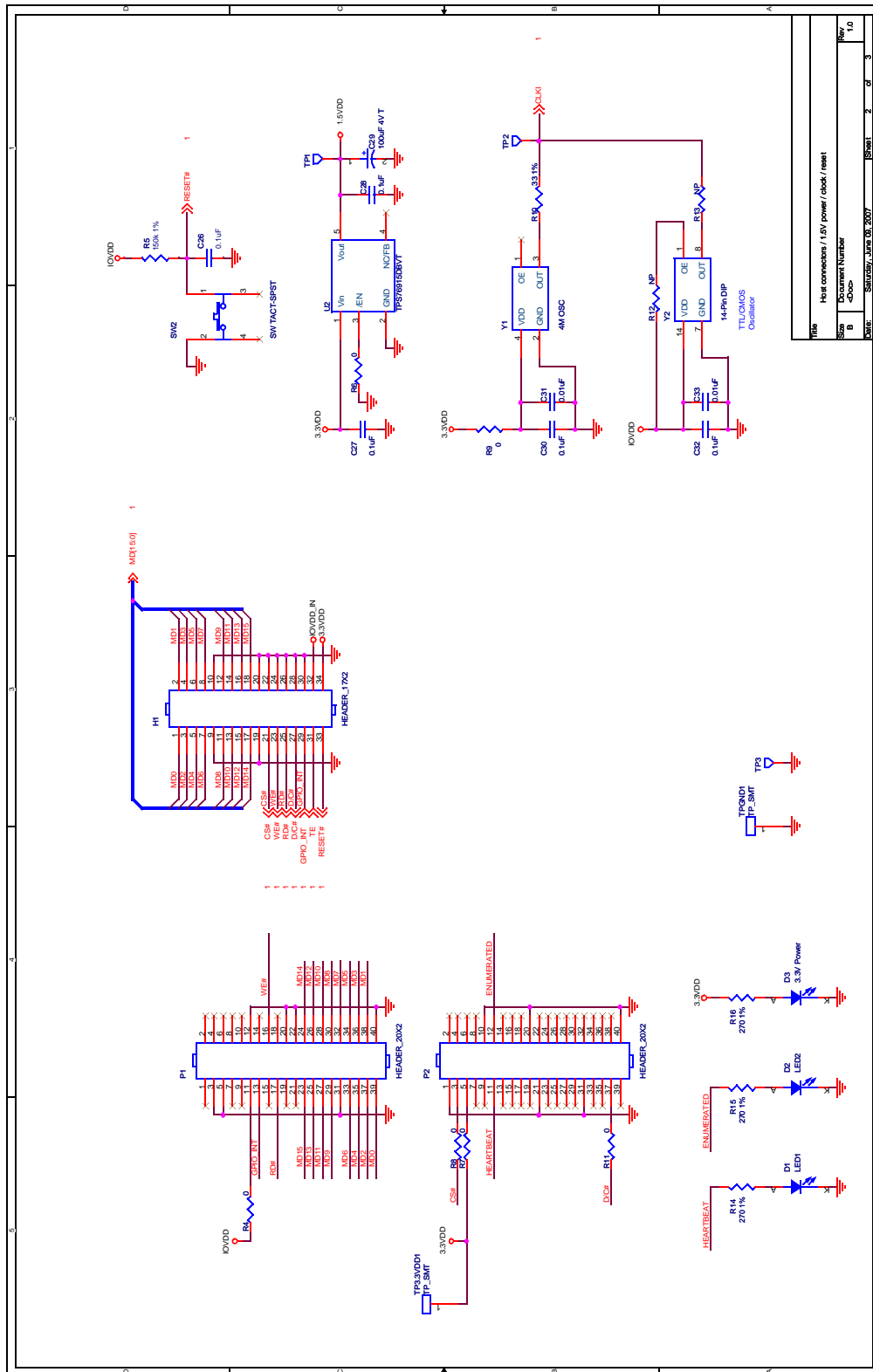

Figure 6-2: S5U13743P00C100 Schematics (2 of 3)

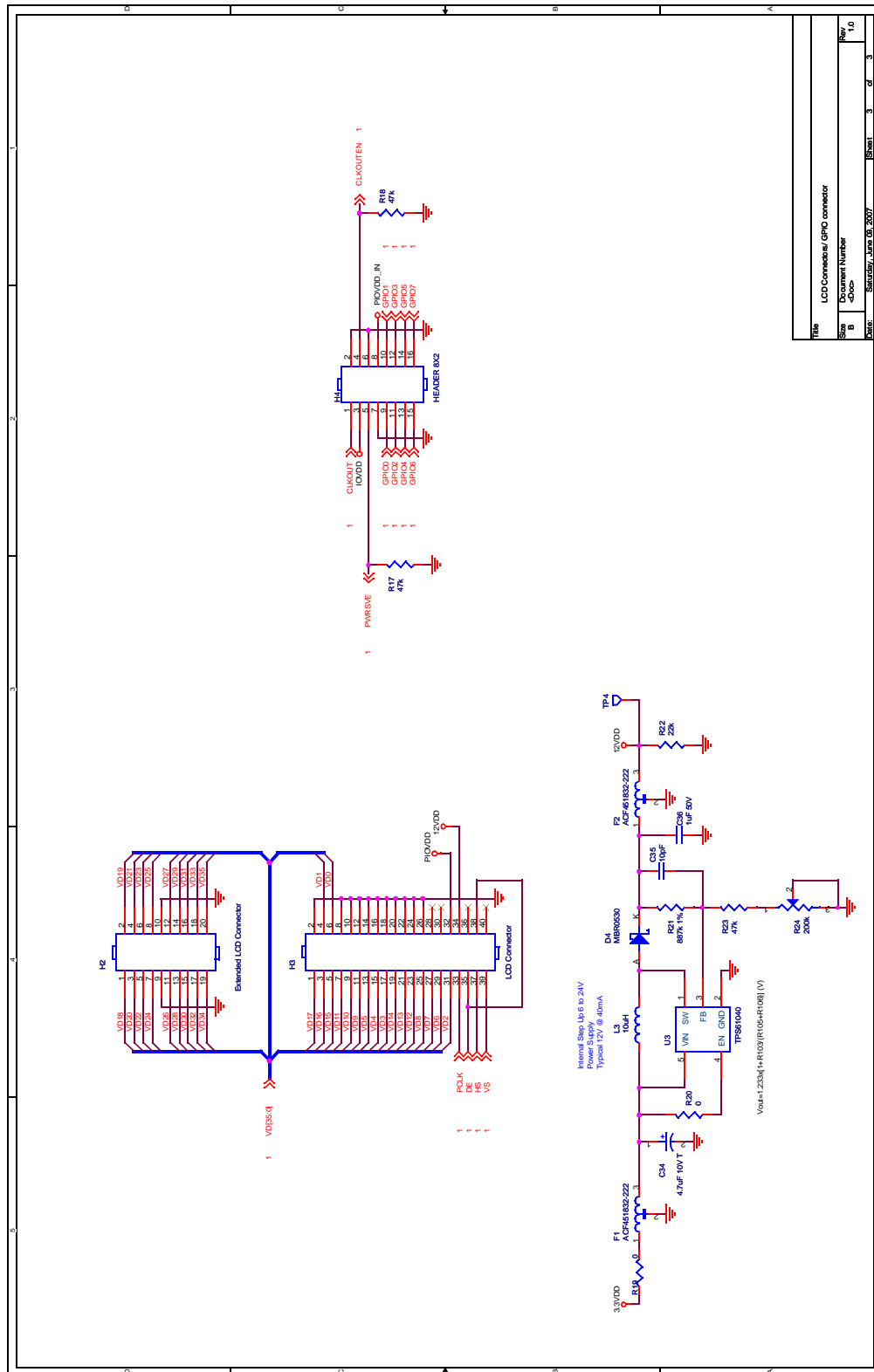

Figure 6-3: S5U13743P00C100 Schematics (3 of 3)

# 7 Board Layout

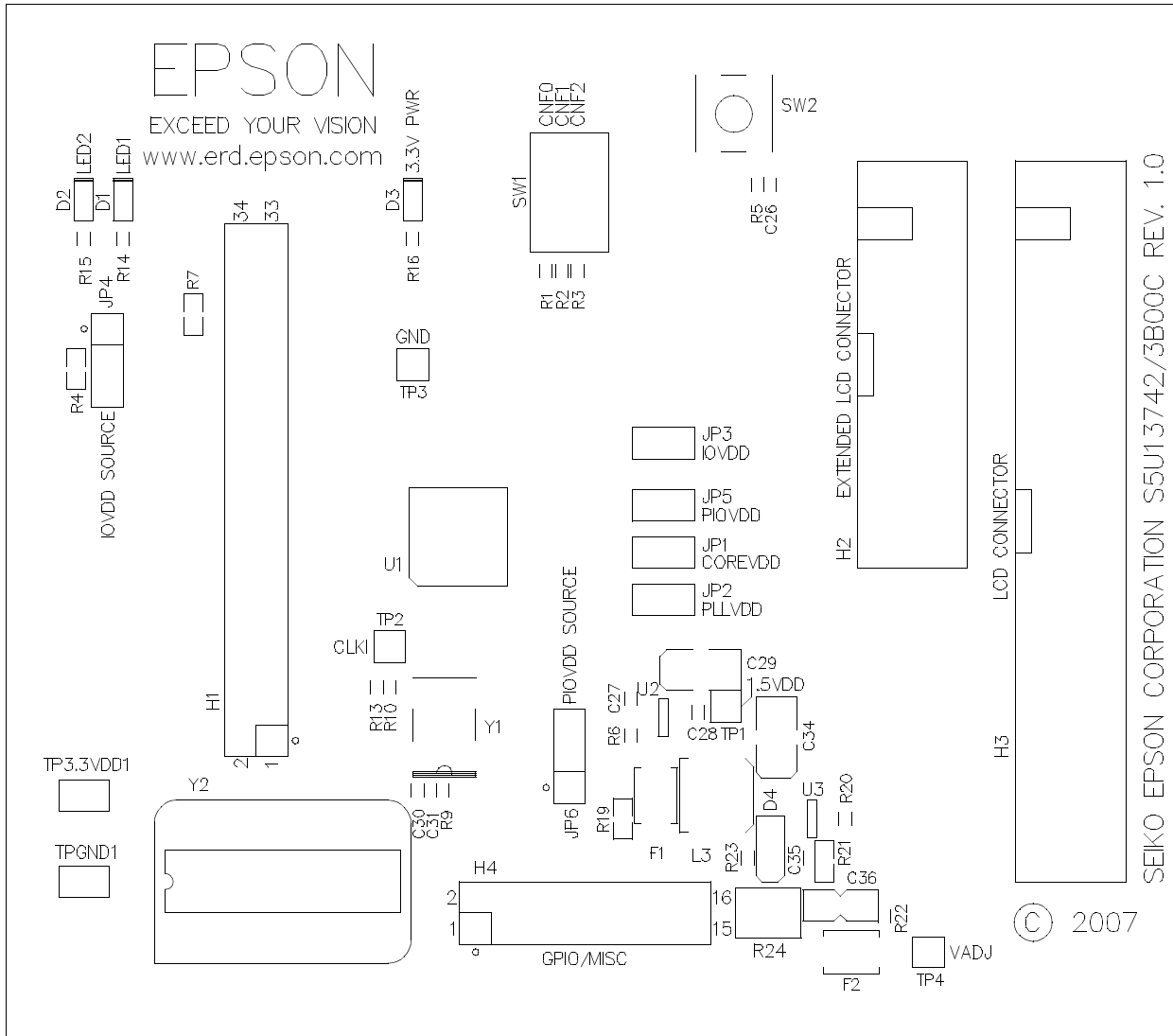

Figure 7-1: S5U13743P00C100 Board Layout - Top View



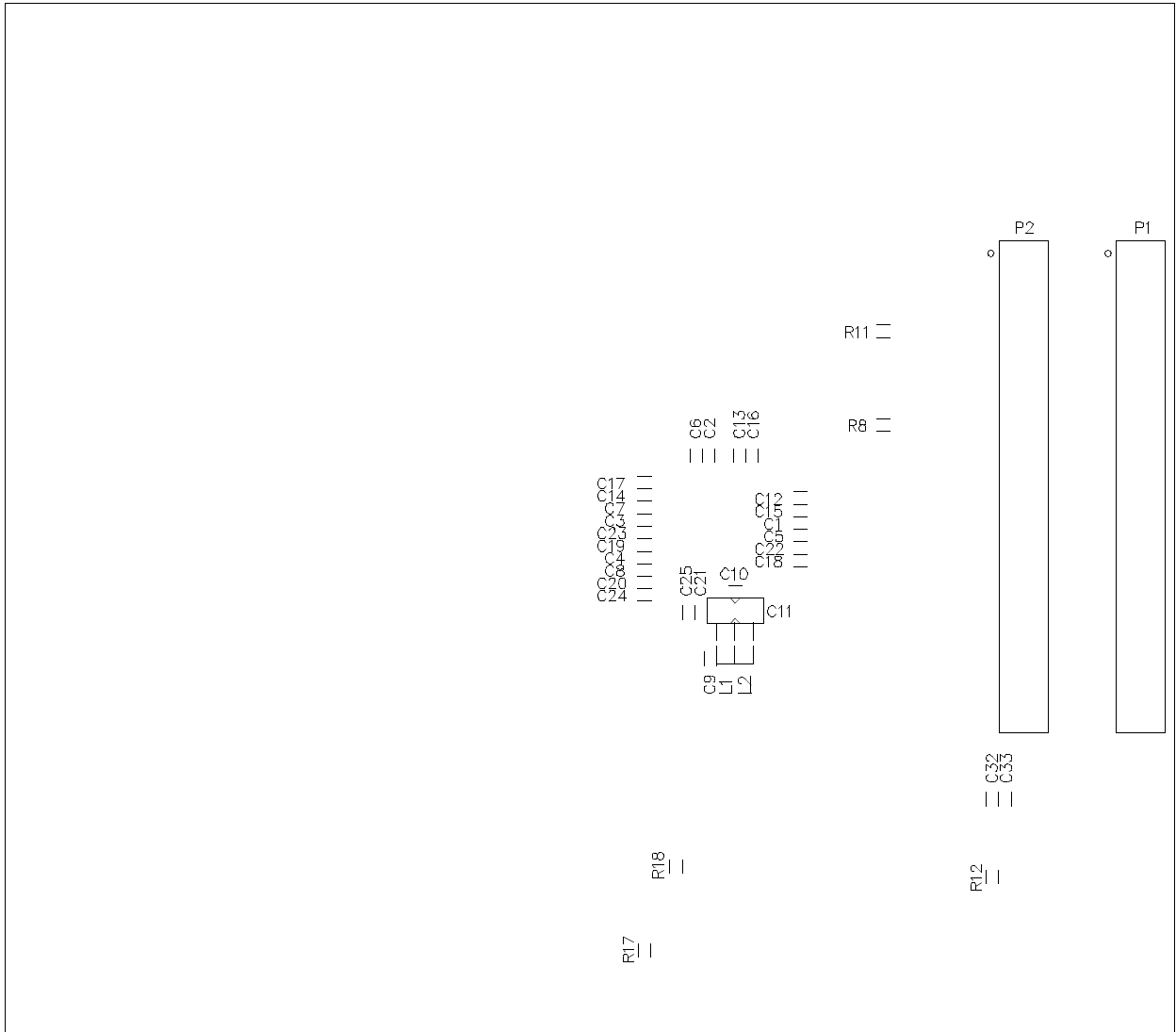

Figure 7-2: S5U13743P00C100 Board Layout - Bottom View

## 8 References

### 8.1 Documents

- Epson Research and Development, Inc., *S1D13743 Hardware Functional Specification*, document number X70A-A-001-xx.

### 8.2 Document Sources

- Epson Research and Development Website: <http://www.erd.epson.com>.

## 9 Technical Support

### 9.1 EPSON Display Controllers (S1D13743)

#### Japan

Seiko Epson Corporation  
IC International Sales Group  
421-8, Hino, Hino-shi  
Tokyo 191-8501, Japan  
Tel: 042-587-5812  
Fax: 042-587-5564  
<http://www.epson.co.jp/>

#### North America

Epson Electronics America, Inc.  
2580 Orchard Parkway  
San Jose, CA 95131, USA  
Tel: (408) 922-0200  
Fax: (408) 922-0238  
<http://www.eea.epson.com/>

#### Taiwan

Epson Taiwan Technology & Trading Ltd.  
14F, No. 7  
Song Ren Road  
Taipei 110, Taiwan, ROC  
Tel: 02-8786-6688  
Fax: 02-8786-6677  
<http://www.epson.com.tw/>

#### Hong Kong

Epson Hong Kong Ltd.  
20/F., Harbour Centre  
25 Harbour Road  
Wanchai, Hong Kong  
Tel: 2585-4600  
Fax: 2827-4346  
<http://www.epson.com.hk/>

#### Europe

Epson Europe Electronics GmbH  
Riesstrasse 15  
80992 Munich, Germany  
Tel: 089-14005-0  
Fax: 089-14005-110  
<http://www.epson-electronics.de/>

#### Singapore

Epson Singapore Pte Ltd  
1 HarbourFront Place #03-02  
HarbourFront Tower One  
Singapore, 098633  
Tel: (65) 6586-5500  
Fax: (65) 6271-3182  
<http://www.epson.com.sg/>

### 9.2 Ordering Information

To order the S5U13743P00C100 Evaluation Board, contact the Epson sales representative in your area and order part number **S5U13743P00C100**.

# Change Record

- X70A-G-001-01      Revision 1.0 - Issued: August 15, 2007
- created from X63A-G-002-01
  - updated for the S1D13743