

## EMC Filters

**Series/Type:**      **B84111A**

The following products presented in this data sheet are being withdrawn.

Ordering Code	Substitute Product	Date of Withdrawal	Deadline Last Orders	Last Shipments
B84111A0000L110		2013-04-12	2013-07-31	2013-10-31
B84111A0000L060		2013-04-12	2013-07-31	2013-10-31
B84111A0000L030		2013-04-12	2013-07-31	2013-10-31

© EPCOS AG 2015. Reproduction, publication and dissemination of this publication, enclosures hereto and the information contained therein without EPCOS' prior express consent is prohibited.

EPCOS AG is a TDK Group Company.



Ordering Code	Substitute Product	Date of Withdrawal	Deadline Last Orders	Last Shipments
B84111A0000K060		2013-04-12	2013-07-31	2013-10-31
B84111A0000K030		2013-04-12	2013-07-31	2013-10-31
B84111A0000K010		2013-04-12	2013-07-31	2013-10-31

For further information please contact your nearest EPCOS sales office, which will also support you in selecting a suitable substitute. The addresses of our worldwide sales network are presented at [www.epcos.com/sales](http://www.epcos.com/sales).

**Power line filters for 1-phase systems**  
**Rated voltage 250 V DC/AC, 50/60 Hz**  
**Rated current 1 to 20 A**



### Alternative version

- Series B84111F (SIFI-F) offers a low-cost solution

### Construction

- 2-line filters
- Metal case
- Polyurethane potting (UL 94 V-0)

### Features

- Compact design
- Optimized leakage current
- Cost-optimized construction
- Also for assembly on top-hat rails
- ENEC10, UL and CSA approval   

### Applications

- Switch-mode power supplies in
  - industrial electronics
  - telecommunications
  - data systems
  - medical equipment
- DC applications

### Case styles and terminal styles

- Case style A Tab connectors on face ends, lateral fixing lugs. Particularly suitable for mounting on a shielding wall.
- Case style B Tab connectors on face ends, fixing lugs on face ends.
- Case style K IEC connector as per IEC 60320 C 14 on line side, tab connectors on load side, mounting holes with metric thread.
- Case style L Litz wires on face ends, fixing lugs on face ends

### Marking

Marking on component:  
 Manufacturer's logo, ordering code,  
 rated voltage, rated current, rated temperature,  
 climatic category, date code

Minimum marking on packaging:  
 Manufacturer's logo, ordering code

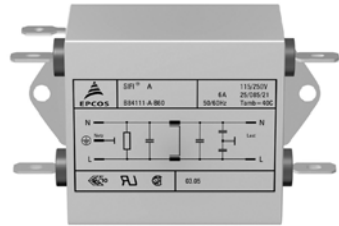

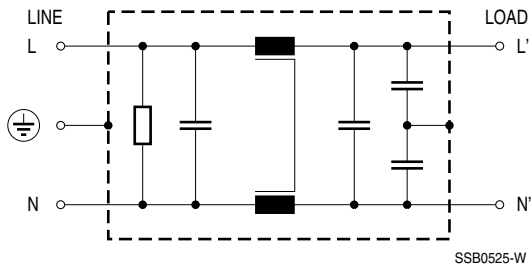
**Circuit diagram**

**Technical data and measuring conditions**

Rated voltage $V_R$	250 V DC/AC 50/60 Hz
Rated current $I_R$	Referred to 40 °C ambient temperature
Test voltage $V_{test}$	1414 V DC, 2 s (line/line) 2700 V DC, 2 s (lines/case)
Leakage current $I_{leak}$	At 230 V AC, 50 Hz
Climatic category (IEC 60068-1)	25/085/21 (-25 °C/+85 °C/21 days damp heat test)
Approvals	EN 133200, UL 1283, CSA C22.2 No.8

**Characteristics and ordering codes**

$I_R$	$C_R$	$L_R$	$I_{leak}$	Case style	Approx. weight	Ordering code	Mounting plate for top-hat rail (ordering code)
A		mH	mA		g		
$V_R = 250$ V DC/AC, 50/60 Hz							
1	$2 \times 0.1 \mu\text{F}$ (X2) + $2 \times 4700$ pF (Y2)	$2 \times 1.5$	< 0.5	A	80	B84111A0000A010	—
				K	140	B84111A0000K010	—
2	$2 \times 0.1 \mu\text{F}$ (X2) + $2 \times 4700$ pF (Y2)	$2 \times 1.5$	< 0.5	A	80	B84111A0000A020	—
3	$2 \times 0.1 \mu\text{F}$ (X2) + $2 \times 4700$ pF (Y2)	$2 \times 1.5$	< 0.5	A	80	B84111A0000A030	—
				K	140	B84111A0000K030	—
				L	80	B84111A0000L030	—
6	$2 \times 0.1 \mu\text{F}$ (X2) + $2 \times 4700$ pF (Y2)	$2 \times 1.8$	< 0.5	A	110	B84111A0000A060	—
				B	110	B84111A0000B060	C62122A0132B091
				K	140	B84111A0000K060	—
				L	110	B84111A0000L060	—
10	$2 \times 0.1 \mu\text{F}$ (X2) + $2 \times 4700$ pF (Y2)	0.82	< 0.5	A	120	B84111A0000A110	—
				B	120	B84111A0000B110	C62122A0132B091
				L	120	B84111A0000L110	—
20	$2 \times 0.1 \mu\text{F}$ (X2) + $2 \times 4700$ pF (Y2)	$2 \times 0.47$	< 0.5	A	210	B84111A0000A120	—
				B	210	B84111A0000B120	C62122A0132B091

**Case styles and dimensions**

Case style	I <sub>R</sub> A	Dimensions (mm)											
		b <sub>1</sub>	b <sub>2</sub>	b <sub>3</sub>	b <sub>4</sub>	l <sub>1</sub>	l <sub>2</sub>	l <sub>3</sub>	l <sub>4</sub>	h <sub>1</sub>	h <sub>2</sub>	Litz mm <sup>2</sup>	Style 1015
A	1	45	26.5	60.4	70	50	—	—	76.5	22.3	14	—	—
K	1	51	—	—	—	63.5	—	—	—	32	—	—	—
A	2	45	26.5	60.4	70	50	—	—	76.5	22.3	14	—	—
A	3	45	26.5	60.4	70	50	—	—	76.5	22.3	14	—	—
K	3	51	—	—	—	63.5	—	—	—	32	—	—	—
L	3	45	—	—	—	50	60.4	70	—	28.6	—	0.82	AWG18
A	6	45	26.5	60.4	70	50	—	—	76.5	28.6	20	—	—
B	6	45	26.5	—	—	50	60.4	70	76.5	28.6	20	—	—
K	6	51	—	—	—	63.5	—	—	—	32	—	—	—
L	6	45	—	—	—	50	60.4	70	—	28.6	—	0.82	AWG18
A	10	45	26.5	60.4	70	50	—	—	76.5	28.6	20	—	—
B	10	45	26.5	—	—	50	60.4	70	76.5	28.6	20	—	—
L	10	45	—	—	—	50	60.4	70	—	28.6	—	1.35	AWG16
A	20	63.5	31.5	74.7	84.5	50.8	—	—	77	38.1	28	—	—
B	20	See dimensional drawing											

**Case style A**

1 ... 3 A (B84111A0000A010, A020, A030)

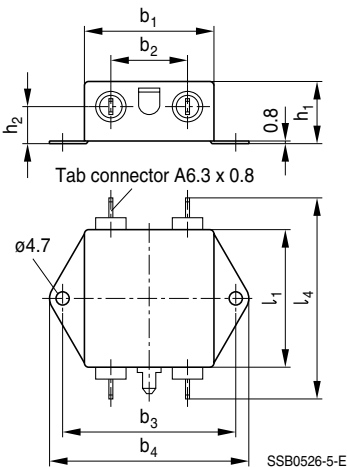

**Case style A**

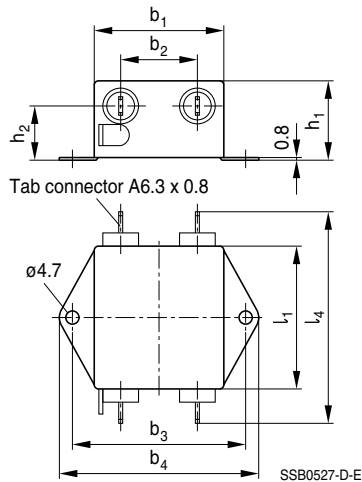
6 ... 20 A (B84111A0000A060, A110, A120)

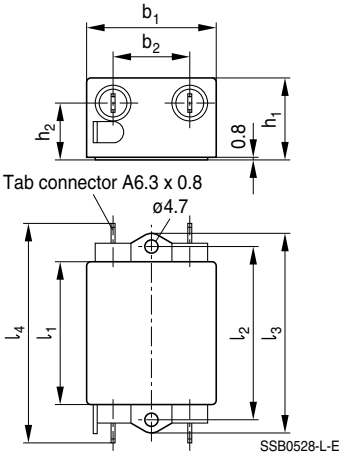

**Case style B**

6 and 10 A (B84111A0000B060, B110)



**Case style B**

20 A (B84111A0000B120)

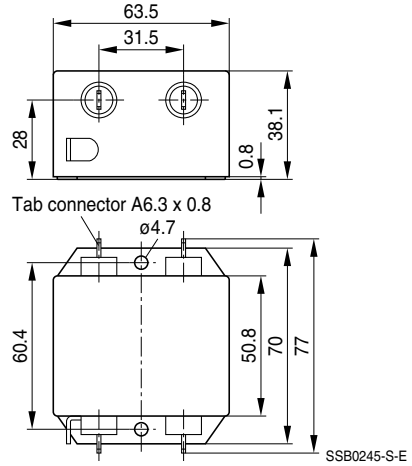

**Case style K**

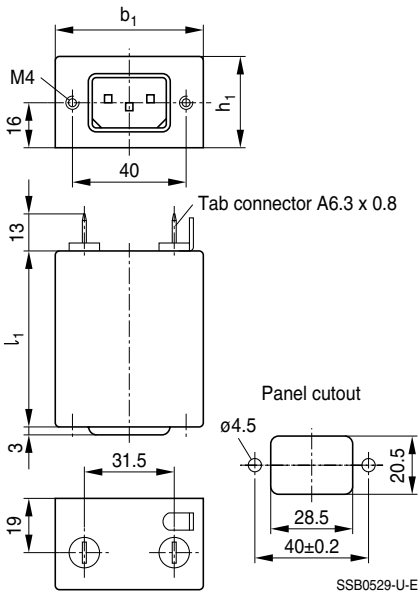

**Case style L**

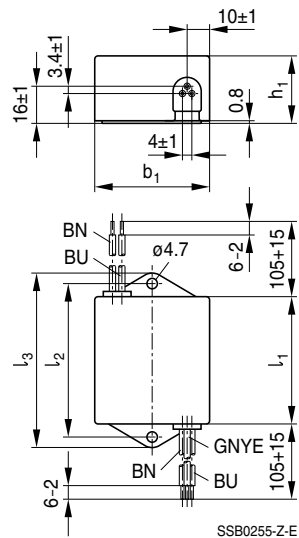

Insertion loss (typical values at  $Z = 50 \Omega$ )

- unsymmetrical, adjacent branches terminated
- - - - - common mode, all branches in parallel (asymmetrical)
- - - - - differential mode (symmetrical)

Filters for 1 to 3 A

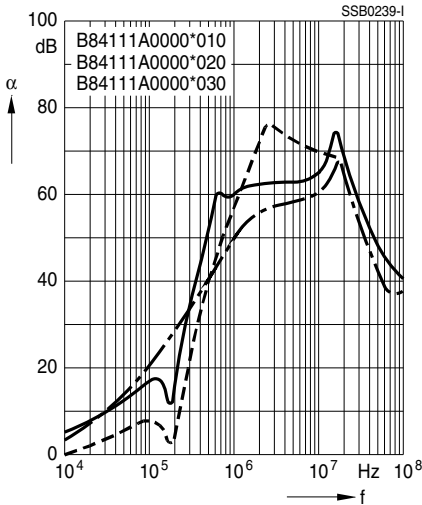

Filters for 6 A

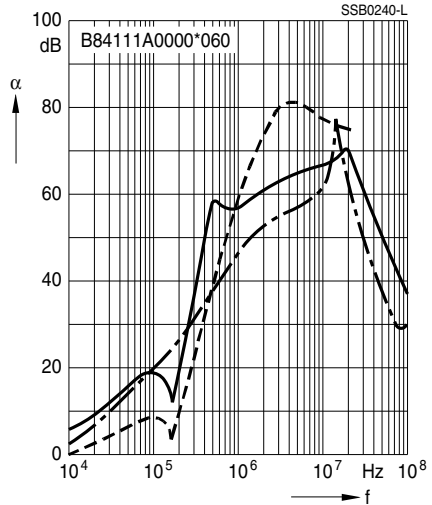

Filters for 10 A

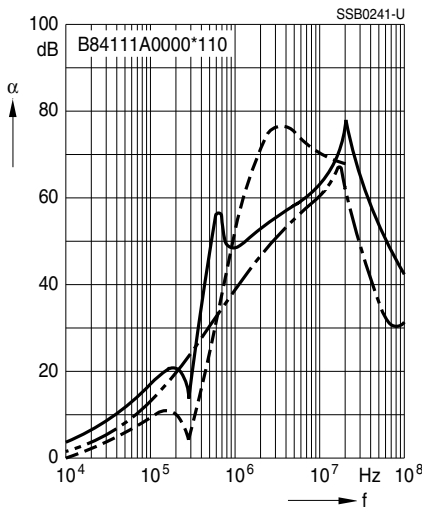

Filters for 20 A

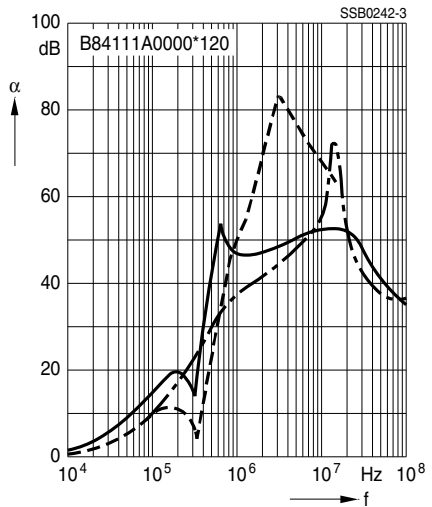



### Important information

Please read all safety and warning notes carefully before installing the EMC filter and putting it into operation (see ) . The same applies to the warning signs on the filter. Please ensure that the signs are not removed nor their legibility impaired by external influences.

Death, serious bodily injury and substantial material damage to equipment may occur if the appropriate safety measures are not carried out or the warnings in the text are not observed.

### Using according to the terms

The EMC filters may be used only for their intended application within the specified values in low-voltage networks in compliance with the instructions given in the data sheets and the data book. The conditions at the place of application must comply with all specifications for the filter used.

### Warnings

- It shall be ensured that only qualified persons (electricity specialists) are engaged on work such as planning, assembly, installation, operation, repair and maintenance. They must be provided with the corresponding documentation.
- Danger of electric shock. EMC filters contain components that store an electric charge. Dangerous voltages can continue to exist at the filter terminals for longer than five minutes even after the power has been switched off.
- The protective earth connections shall be the first to be made when the EMC filter is installed and the last to be disconnected. Depending on the magnitude of the leakage currents, the particular specifications for making the protective-earth connection must be observed.
- Impermissible overloading of the EMC filter, such as impermissible voltages at higher frequencies that may cause resonances etc. can lead to destruction of the filter housing.
- EMC filters must be protected in the application against impermissible exceeding of the rated currents by suitable overcurrent protective.

The following applies to all products named in this publication:

1. Some parts of this publication contain **statements about the suitability of our products for certain areas of application**. These statements are based on our knowledge of typical requirements that are often placed on our products in the areas of application concerned. We nevertheless expressly point out **that such statements cannot be regarded as binding statements about the suitability of our products for a particular customer application**. As a rule, EPCOS is either unfamiliar with individual customer applications or less familiar with them than the customers themselves. For these reasons, it is always ultimately incumbent on the customer to check and decide whether an EPCOS product with the properties described in the product specification is suitable for use in a particular customer application.
2. We also point out that **in individual cases, a malfunction of passive electronic components or failure before the end of their usual service life cannot be completely ruled out in the current state of the art, even if they are operated as specified**. In customer applications requiring a very high level of operational safety and especially in customer applications in which the malfunction or failure of a passive electronic component could endanger human life or health (e.g. in accident prevention or life-saving systems), it must therefore be ensured by means of suitable design of the customer application or other action taken by the customer (e.g. installation of protective circuitry or redundancy) that no injury or damage is sustained by third parties in the event of malfunction or failure of a passive electronic component.
3. **The warnings, cautions and product-specific notes must be observed.**
4. In order to satisfy certain technical requirements, **some of the products described in this publication may contain substances subject to restrictions in certain jurisdictions (e.g. because they are classed as “hazardous”)**. Useful information on this will be found in our Material Data Sheets on the Internet ([www.epcos.com/material](http://www.epcos.com/material)). Should you have any more detailed questions, please contact our sales offices.
5. We constantly strive to improve our products. Consequently, **the products described in this publication may change from time to time**. The same is true of the corresponding product specifications. Please check therefore to what extent product descriptions and specifications contained in this publication are still applicable before or when you place an order.  
We also **reserve the right to discontinue production and delivery of products**. Consequently, we cannot guarantee that all products named in this publication will always be available.
6. Unless otherwise agreed in individual contracts, **all orders are subject to the current version of the “General Terms of Delivery for Products and Services in the Electrical Industry” published by the German Electrical and Electronics Industry Association (ZVEI)**.
7. The trade names EPCOS, EPCOS-Jones, Baoke, CeraDiode, CSSP, MLSC, PhaseCap, PhaseMod, SIFI, SIKOREL, SilverCap, SIMID, SIOV, SIP5D, SIP5K, UltraCap, WindCap are **trademarks registered or pending** in Europe and in other countries. Further information will be found on the Internet at [www.epcos.com/trademarks](http://www.epcos.com/trademarks).