

SIOV metal oxide varistors

Leaded varistors, Automotive 42 V series

Series/Type: B722*
Date: December 2011

© EPCOS AG 2015. Reproduction, publication and dissemination of this publication, enclosures hereto and the information contained therein without EPCOS' prior express consent is prohibited.

EPCOS AG is a TDK Group Company.

Automotive series for 42 V
Construction

- Round varistor element, leaded
- Coating: phenolic resin

Features

- Automotive series for 42 V supply systems
- This series complies with the electrical requirements for the new 42 V board net as specified in draft standard ISO/TC22 WD42V-1E
- Stable protection level, minimum leakage current
- High resistance to cyclic temperature stress: 1000 cycles
- High operating temperature up to 125 °C

Delivery mode

- Bulk (standard), taped versions on reel or in Ammo pack upon request.
- For further details refer chapter "Taping, packaging and lead configuration" for leaded varistors.

General technical data

Climatic category	to IEC 60068-1	40/125/56	
Operating temperature		-40 ... +125	°C
Storage temperature		-40 ... +150	°C
Response time		< 25	ns

Electrical specifications and ordering codes
Maximum ratings ($T_A = 125\text{ °C}$)

Ordering code	Type (untaped) SIOV-	$V_{\text{RMS, op, max}}^{1)}$ V_{DC}	$V_{\text{op, max}}^{2)}$ V_{DC}	$V_{\text{max, dyn}}^{3)}$ V_{DC}	W_{max} (2 ms) J	P_{max} W
42-V supply systems						
B72207S1390K201	S07V42AUTOS2D1	48	50	58	3.0	0.02
B72210S1390K501	S10V42AUTOS5D1	48	50	58	6.4	0.05
B72214S1390K501	S14V42AUTOS5D1	48	50	58	13.0	0.10
B72220S1390K501	S20V42AUTOS5D1	48	50	58	37.0	0.20

1) Root-mean-square value of max. DC operating voltage incl. ripple

2) Peak value of max. DC operating voltage incl. ripple

3) Max. dynamic overvoltage as per ISO/TC22 WD24V-1E, $t_b \leq 400\text{ ms}$

Characteristics ($T_A = 25\text{ °C}$)

Ordering code	Type (untaped) SIOV-	V_V (1 mA) V	ΔV_V (1 mA) %	$V_{c, \text{max}}$ (i_c) V	i_c A	C_{typ} (1 kHz) nF
42-V supply systems						
B72207S1390K201	S07V42AUTOS2D1	68	± 10	135	2.5	0.90
B72210S1390K501	S10V42AUTOS5D1	68	± 10	135	5.0	2.10
B72214S1390K501	S14V42AUTOS5D1	68	± 10	135	10.0	3.55
B72220S1390K501	S20V42AUTOS5D1	68	± 10	135	20.0	6.75

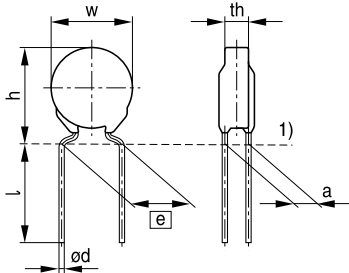
Dimensional drawings

1) Seating plane to IEC 60717 VAR0553-D-E

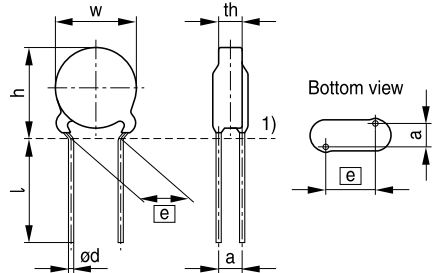

1) Seating plane to IEC 60717 VAR0545-M-E

S07V42AUTOS2D1
S10, S14, S20V42AUTOS5D1
Dimensions

Ordering code	[e] ±1 mm	a ±1 mm	w _{max} mm	th _{max} mm	h _{max} mm	l _{min} mm	d ±0.05 mm
B72207S1390K201	5.0	1.7	9.0	4.1	12.5	25.0	0.6
B72210S1390K501	7.5	2.0	12.0	4.8	16.0	25.0	0.8
B72214S1390K501	7.5	2.1	16.0	4.9	20.0	25.0	0.8
B72220S1390K501	10.0	2.3	22.0	5.5	27.0	25.0	1.0

Weight

Nominal diameter mm	V _{RMS, op, max} V	Weight g
7	48	0.5
10	48	1.0
14	48	2.5
20	48	5.0

Reliability data

Test	Test methods/conditions	Requirement
Varistor voltage	The voltage between two terminals with the specified measuring current applied is called V_V (1 mA _{DC} @ 0.2 ... 2 s).	To meet the specified value
Clamping voltage	The maximum voltage between two terminals with the specified standard impulse current (8/20 μ s) applied.	To meet the specified value
Max. DC operating voltage	MIL STD 202F, method 108A, UCT, V _{DC} , 1000 h	$ \Delta V/V (1 \text{ mA}) \leq 10\%$ No visible damage
Fast temperature cycling	IEC 60068-2-14, test Na, LCT/UCT, dwell time 15 min, 100 cycles for SIOV...AUTO types and dwell time 15 min, 1000 cycles for SIOV...AUTOD1 types	$ \Delta V/V (1 \text{ mA}) \leq 5\%$ No visible damage
Damp heat	IEC 60068-2-67, test Cy, 85 °C, 85% r. H., V _{DC} , 1000 h	$ \Delta V/V (1 \text{ mA}) \leq 10\%$ No visible damage

Note:

UCT = Upper category temperature

LCT = Lower category temperature



v/i characteristics

$v = f(i)$ for explanation of the characteristics refer to "General technical information", 1.6.3

A = Leakage current, B = Protection level } for worst-case varistor tolerances

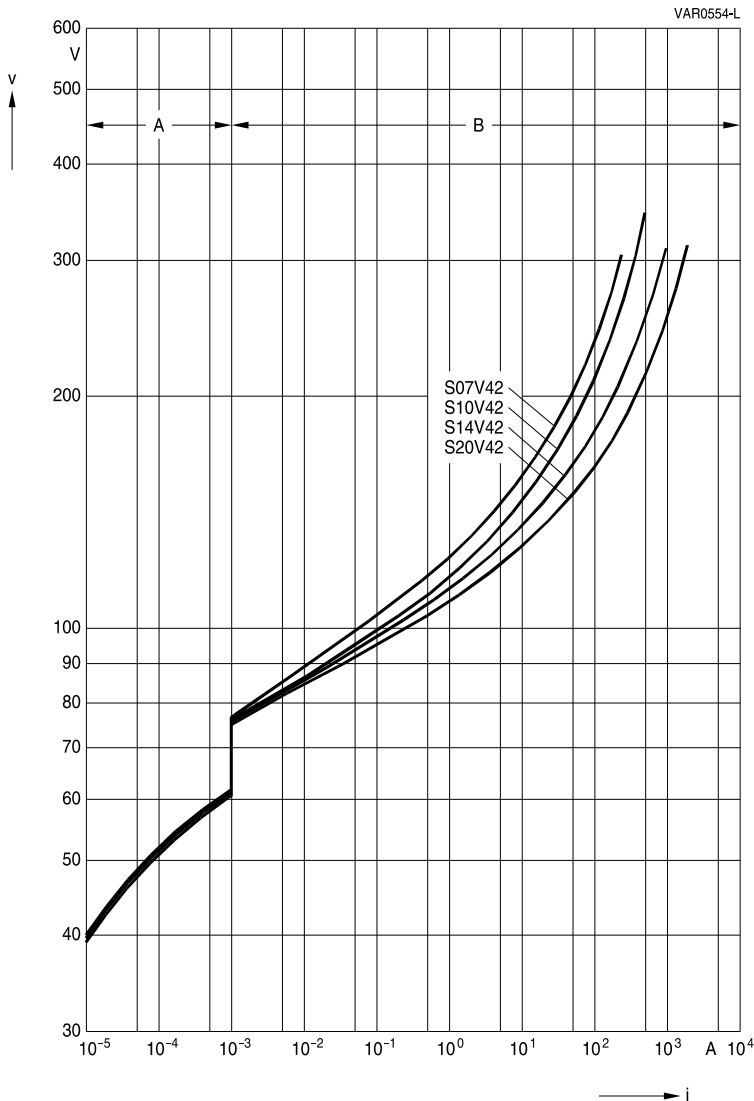

SIOV-S07V24AUTOS2D1

SIOV-S10(-S14)(-S20)V42AUTOS5D1

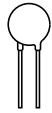

Derating curves

Maximum surge current $i_{max} = f(t_r, \text{pulse train})$

For explanation of the derating curves refer to "General technical information", section 1.8.1

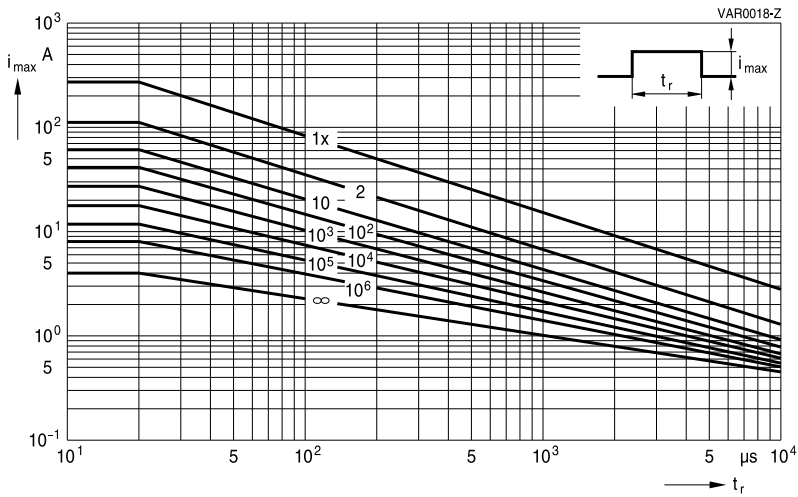

SIOV-S07V42AUTOS2D1

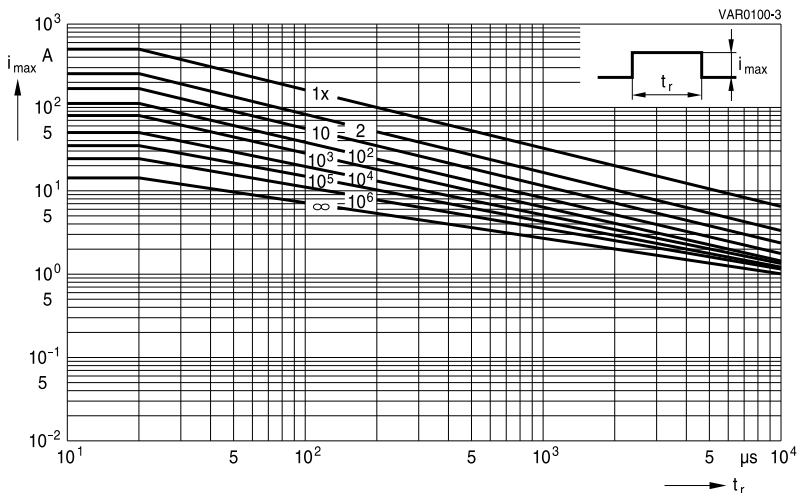

SIOV-S10V42AUTOS5D1



Derating curves

Maximum surge current $i_{max} = f(t_r, \text{pulse train})$

For explanation of the derating curves refer to "General technical information", section 1.8.1

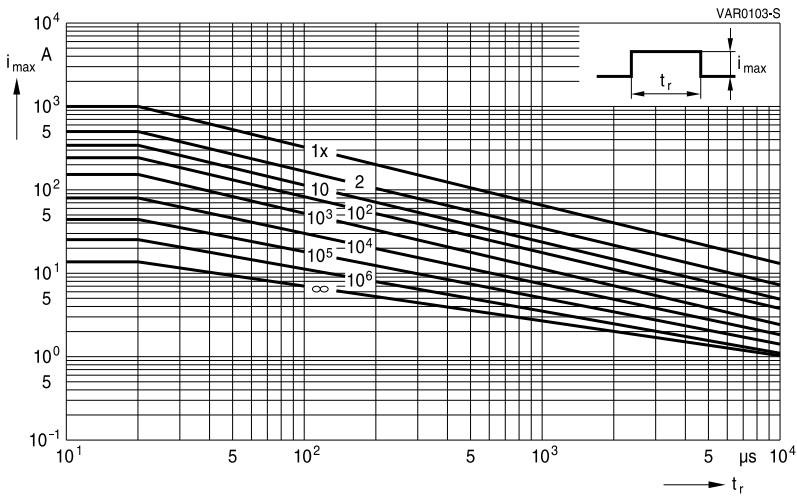

SIOV-S14V42AUTOS5D1

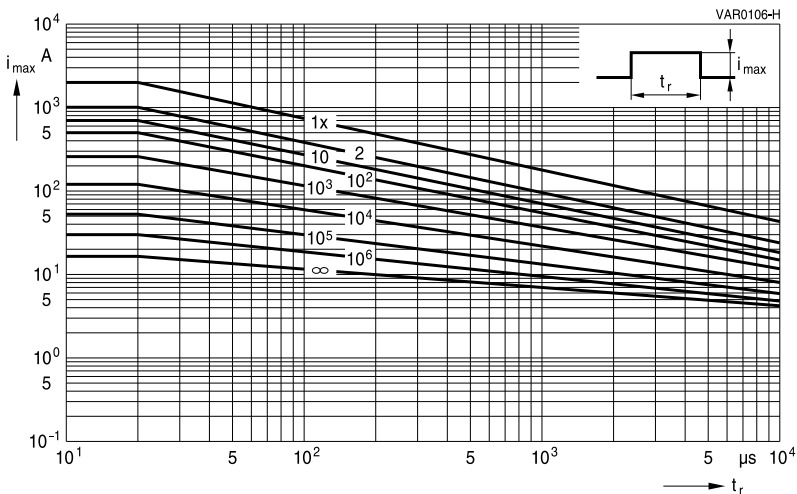

SIOV-S20V42AUTOS5D1

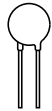

Leaded varistors

B722*

Automotive series for 42 V

Taping, packaging and lead configuration

1 EPCOS ordering code system

For leaded varistors

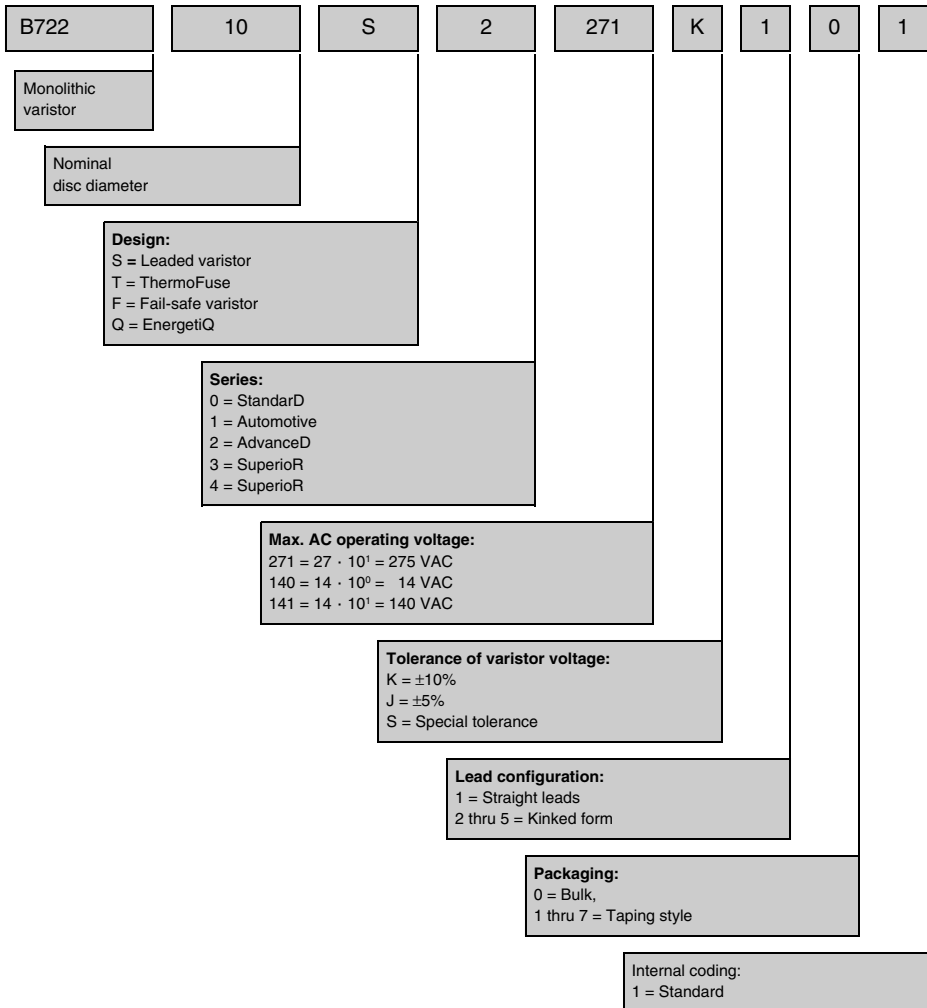



Leaded varistors

B722*

Automotive series for 42 V

2 Taping and packaging of leaded varistors

Tape packaging for lead spacing \boxed{e} = 5 fully conforms to IEC 60286-2, while for lead spacings \boxed{e} = 7.5 and 10 the taping mode is based on this standard.

2.1 Taping in accordance with IEC 60286-2 for lead spacing 5.0 mm

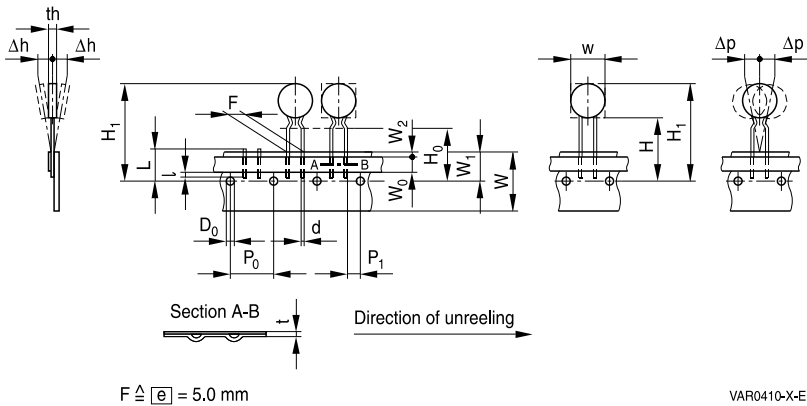

2.2 Taping based on IEC 60286-2 for lead spacing 7.5 and 10 mm

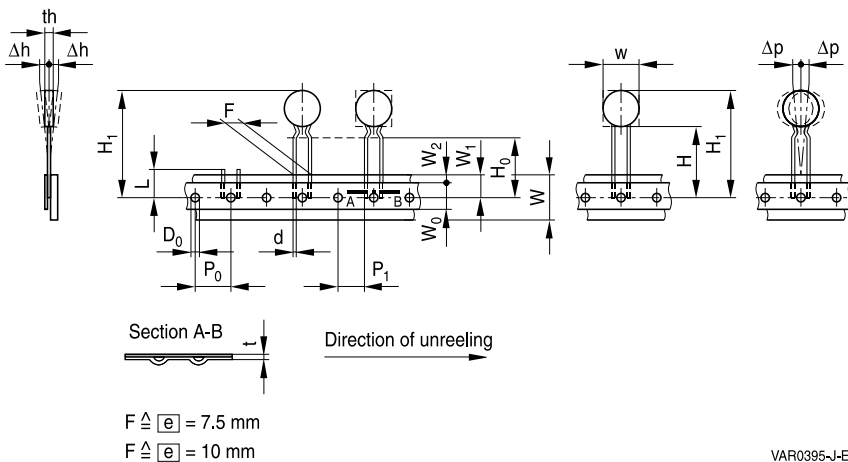



2.3 Tape dimensions (in mm)

Symbol	$e = 5.0$	Tolerance	$e = 7.5$	Tolerance	$e = 10.0$	Tolerance	Remarks
w		max.		max.		max.	see tables in each series under "Dimensions"
th		max.		max.		max.	
d	0.6	± 0.05	0.8	± 0.05	1.0	± 0.05	
P ₀	12.7	± 0.3	12.7 ¹⁾	± 0.3	12.7	± 0.3	± 1 mm/20 sprocket holes
P ₁	3.85	± 0.7	8.95	± 0.8	7.7	± 0.8	
F	5.0	$+0.6/-0.1$	7.5	± 0.8	10.0	± 0.8	measured at top of component body
Δh	0	± 2.0	depends on s		depends on s		
Δp	0	± 1.3	0	± 2.0	0	± 2.0	
W	18.0	± 0.5	18.0	± 0.5	18.0	± 0.5	Peel-off force ≥ 5 N
W ₀	5.5	min.	11.0	min.	11.0	min.	
W ₁	9.0	± 0.5	9.0	$+0.75/-0.5$	9.0	$+0.75/-0.5$	
W ₂	3.0	max.	3.0	max.	3.0	max.	
H	18.0	$+2.0/-0$	18.0	$+2.0/-0$	18.0	$+2.0/-0$	2) 3)
H ₀	16.0 (18.0)	± 0.5	16.0 (18.0)	± 0.5	16.0	± 0.5	
H ₁	32.2	max.	45.0	max.	45.0	max.	
D ₀	4.0	± 0.2	4.0	± 0.2	4.0	± 0.2	without lead
t	0.9	max.	0.9	max.	0.9	max.	
L	11.0	max.	11.0	max.	11.0	max.	
l	4.0	max.					

1) Taping with P₀ = 15.0 mm upon request

2) Applies only to uncrimped types

3) Applies only to crimped types (H₀ = 18 upon request)



2.4 Taping mode

Example: B72210S0271K1 5 1
|
Digit 14

Digit 14	Taping mode	Reel type	Seating plane height H ₀ for crimped types mm	Seating plane height H for uncrimped types mm	Pitch distance P ₀ mm
0	–	Bulk	–	–	–
1	G	I	16	18	12.7
2	G2	I	18	–	12.7
3	G3	II	16	18	12.7
4	G4	II	18	–	12.7
5	G5	III	16	18	12.7
6	GA	Ammo pack	16	18	12.7
7	G2A	Ammo pack	18	–	12.7
Internal coding for special taping					
	G6	III	18	–	12.7
	G10	II	16	18	15.0
	G11	II	18	–	15.0
	G10A	Ammo pack	16	18	15.0
	G11A	Ammo pack	18	–	15.0



2.5 Reel dimension

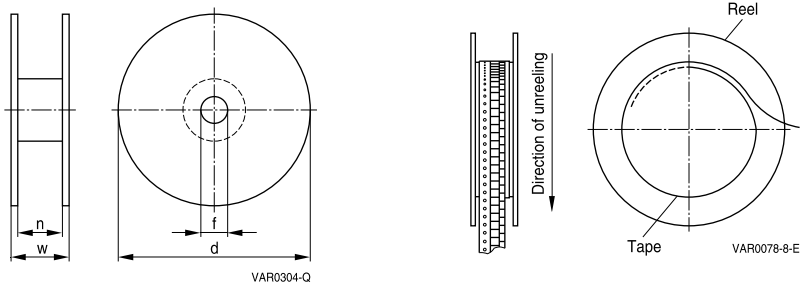

Dimensions (in mm)

Reel type	d	f	n	w
I	360 max.	31 ±1	approx. 45	54 max.
II	360 max.	31 ±1	approx. 55	64 max.
III	500 max.	23 ±1	approx. 59	72 max.

If reel type III is not compatible with insertion equipment because of its large diameter, nominal disk diameter 10 mm and 14 mm can be supplied on reel II upon request (taping mode G3).

2.6 Ammo pack dimensions

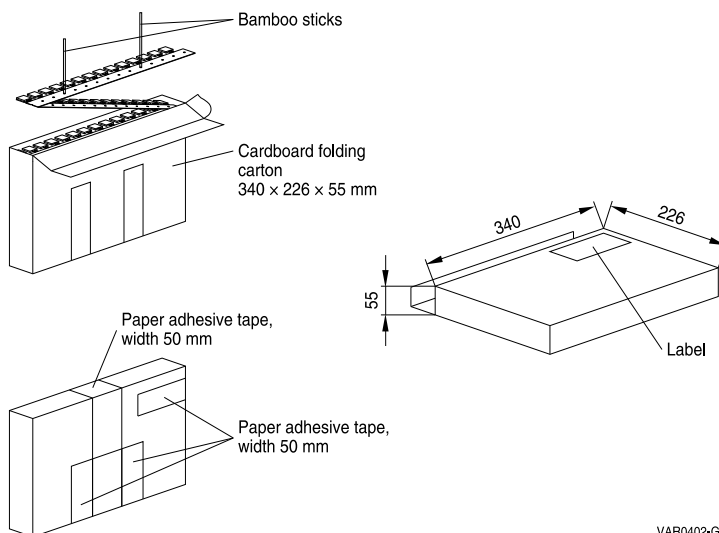

VAR0402-G



3 Lead configuration

Straight leads are standard for disk varistors. Other lead configurations as crimp style or customer-specific lead wire length according to 3.1, 3.2, 3.3 and 3.4 are optional. Crimped leads (non-standard) are differently crimped for technical reasons; the individual crimp styles are denoted by consecutive numbers (S, S2 through S5) as shown in the dimensional drawings below.

The crimp styles of the individual types can be seen from the type designation in the ordering tables.

3.1 Crimp style mode

Example: B72210S0271K **5** 01

Digit 13

Digit 13 of ordering code	Crimp style	Figure
1	Standard, straight leads	1
2	S2	2
3	S3	3
4	S4	4
5	S5	5
Available upon request		
Internal coding	—	6

3.2 Standard leads and non-standard crimp styles

Standard, straight leads

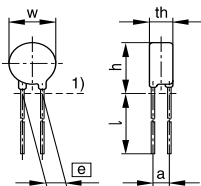

1) Seating plane to IEC 717
VAR0586-W-E

Figure 1

Non-standard, crimp style S2

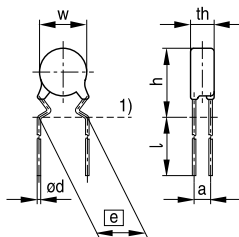

1) Seating plane to IEC 60717
VAR0411-F-E

Figure 2

Non-standard, crimp style S3

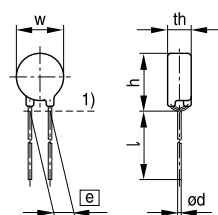

1) Seating plane to IEC 60717
VAR0396-R-E

Figure 3

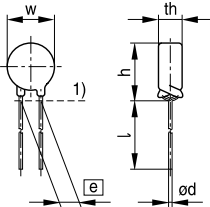
Non-standard, crimp style S4

1) Seating plane to IEC 60717
VAR0404-W-E

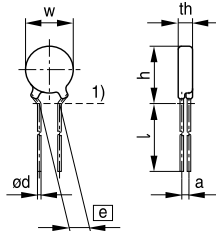
Non-standard, crimp style S5

1) Seating plane to IEC 60717
VAR0412-N-E

Figure 4
Figure 5

3.3 Component height (h_{max}) for crimped versions (non-standard)

Due to technical reasons the component height (h_{max}) increases if a crimp is added. The maximum height of the crimped component can be found in the table below.

Nominal diameter mm	V_{RMS} V	Crimp style	e mm	h_{max} mm
5	11 ... 175	S2	5.0	10.0
5	210 ... 460	S3	5.0	10.0
7	11 ... 175	S2	5.0	12.0
7	210 ... 460	S3	5.0	12.0
10	11 ... 300	S5	7.5	15.5
10	320 ... 460	S3/S5	7.5	16.5
10	510	S3/S5	7.5	17.5
10	Automotive	S5	7.5	17.0
10	Automotive (D1 types)	S5	7.5	16.0
10	11 ... 175	S4	5.0	16.5
10	210 ... 460	S3	5.0	16.5
14	11 ... 300	S5	7.5	20.0
14	320 ... 460	S3/S5	7.5	20.0
14	510	S3/S5	7.5	21.5
14	Automotive	S5	7.5	21.0
14	Automotive (D1 types)	S5	7.5	20.0
20	11 ... 320	S5	10.0	27.0
20	385 ... 510	S5	10.0	27.5



3.4 Trimmed leads (non-standard)

Varistors with cut leads available upon request.

Lead length tolerances:

Straight leads ± 1.0 mm

Crimped leads ± 0.8 mm

Minimum lead length 3.5 mm

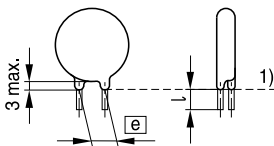

1) Seating plane to IEC 60717

VAR0642-U-E

Figure 6



Mounting

1. Potting, sealing or adhesive compounds can produce chemical reactions in the SIOV ceramic that will degrade the component's electrical characteristics.
2. Overloading SIOVs may result in ruptured packages and expulsion of hot materials. For this reason SIOVs should be physically shielded from adjacent components.

Operation

1. Use SIOVs only within the specified temperature operating range.
2. Use SIOVs only within the specified voltage and current ranges.
3. Environmental conditions must not harm SIOVs. Use SIOVs only in normal atmospheric conditions. Avoid use in deoxidizing gases (chlorine gas, hydrogen sulfide gas, ammonia gas, sulfuric acid gas etc), corrosive agents, humid or salty conditions. Contact with any liquids and solvents should be prevented.

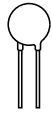
Symbols and terms

Symbol	Term
C	Capacitance
C_{typ}	Typical capacitance
i	Current
i_c	Current at which $V_{c, max}$ is measured
I_{leak}	Leakage current
i_{max}	Maximum surge current (also termed peak current)
I_{max}	Maximum discharge current to IEC 61643-1
I_{nom}	Nominal discharge current to IEC 61643-1
LCT	Lower category temperature
L_{typ}	Typical inductance
P_{max}	Maximum average power dissipation
R_{ins}	Insulation resistance
R_{min}	Minimum resistance
T_A	Ambient temperature
t_r	Duration of equivalent rectangular wave
UCT	Upper category temperature
v	Voltage
V_{clamp}	Clamping voltage
$V_{c, max}$	Maximum clamping voltage at specified current i_c
V_{DC}	DC operating voltage
V_{jump}	Maximum jump start voltage
V_{max}	Maximum voltage
V_{op}	Operating voltage
V_{RMS}	AC operating voltage, root-mean-square value
$V_{RMS, op, max}$	Root-mean-square value of max. DC operating voltage incl. ripple current
V_{surge}	Super imposed surge voltage
V_V	Varistor voltage
ΔV_V	Tolerance of varistor voltage
W_{LD}	Maximum load dump
W_{max}	Maximum energy absorption
e	Lead spacing

All dimensions are given in mm.

The commas used in numerical values denote decimal points.

Important notes

The following applies to all products named in this publication:

1. Some parts of this publication contain **statements about the suitability of our products for certain areas of application**. These statements are based on our knowledge of typical requirements that are often placed on our products in the areas of application concerned. We nevertheless expressly point out **that such statements cannot be regarded as binding statements about the suitability of our products for a particular customer application**. As a rule, EPCOS is either unfamiliar with individual customer applications or less familiar with them than the customers themselves. For these reasons, it is always ultimately incumbent on the customer to check and decide whether an EPCOS product with the properties described in the product specification is suitable for use in a particular customer application.
2. We also point out that **in individual cases, a malfunction of electronic components or failure before the end of their usual service life cannot be completely ruled out in the current state of the art, even if they are operated as specified**. In customer applications requiring a very high level of operational safety and especially in customer applications in which the malfunction or failure of an electronic component could endanger human life or health (e.g. in accident prevention or lifesaving systems), it must therefore be ensured by means of suitable design of the customer application or other action taken by the customer (e.g. installation of protective circuitry or redundancy) that no injury or damage is sustained by third parties in the event of malfunction or failure of an electronic component.
3. **The warnings, cautions and product-specific notes must be observed.**
4. In order to satisfy certain technical requirements, **some of the products described in this publication may contain substances subject to restrictions in certain jurisdictions (e.g. because they are classed as hazardous)**. Useful information on this will be found in our Material Data Sheets on the Internet (www.epcos.com/material). Should you have any more detailed questions, please contact our sales offices.
5. We constantly strive to improve our products. Consequently, **the products described in this publication may change from time to time**. The same is true of the corresponding product specifications. Please check therefore to what extent product descriptions and specifications contained in this publication are still applicable before or when you place an order. We also **reserve the right to discontinue production and delivery of products**. Consequently, we cannot guarantee that all products named in this publication will always be available. The aforementioned does not apply in the case of individual agreements deviating from the foregoing for customer-specific products.
6. Unless otherwise agreed in individual contracts, **all orders are subject to the current version of the "General Terms of Delivery for Products and Services in the Electrical Industry" published by the German Electrical and Electronics Industry Association (ZVEI)**.
7. The trade names EPCOS, BAOKE, Alu-X, CeraDiode, CSMP, CSSP, CTVS, DeltaCap, DigiSiMic, DSSP, FormFit, MiniBlue, MiniCell, MKD, MKK, MLSC, MotorCap, PCC, PhaseCap, PhaseCube, PhaseMod, PhiCap, SIFERRIT, SIFI, SIKOREL, SilverCap, SIMDAD, SiMic, SIMID, SineFormer, SIOV, SIP5D, SIP5K, ThermoFuse, WindCap are **trademarks registered or pending** in Europe and in other countries. Further information will be found on the Internet at www.epcos.com/trademarks.