



## **SMD NTC thermistors**

SMD NTC thermistor, standard series

**Series/Type:**  
**Ordering code:**        **B57423V2473H062**  
Date:                        2012-07-19  
Version:                    3

## Applications

Temperature measurement and compensation for

- charging control of battery packs in portable devices
- LCDs and power amplifiers in mobile phones, car radio equipment, etc.
- HDD in computers, digital cameras, DVD recorders
- air-conditioning and heating control systems
- LED lighting

## Features

- EIA case size 0805
- Multilayer SMD NTC thermistor with nickel barrier termination (AgNiSn)
- Excellent long-term aging stability in high temperature and high humidity environment

## Dimensional drawing

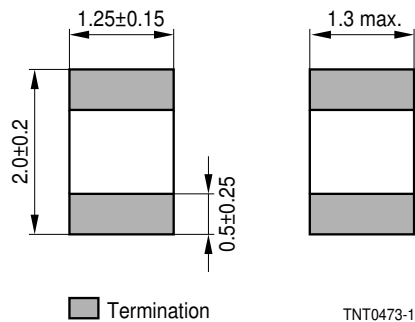

Dimensions in mm

## Electrical specifications

Ordering code	Zero-power resistance (at 25 °C)	B <sub>25/100</sub>	B <sub>25/85</sub>	B <sub>25/50</sub>
B57423V2473H062	47 kΩ ±3%	4000 K ±1.5%	(3980 K)	(3940 K)

Operating temperature range	T <sub>op</sub>	-55 ... 125	°C
Maximum power (at 25 °C, on PCB)	P <sub>25</sub> <sup>1)</sup>	210	mW
Resistance tolerance	ΔR <sub>R</sub> /R <sub>R</sub>	±3	%
Rated temperature	T <sub>R</sub>	25	°C
Dissipation factor (on PCB)	δ <sub>th</sub> <sup>1)</sup>	approx. 3.5	mW/K
Thermal cooling time constant (on PCB)	τ <sub>c</sub> <sup>1)</sup>	approx. 10	s
Heat capacity	C <sub>th</sub> <sup>1)</sup>	approx. 35	mJ/K
Weight of component		approx. 13	mg

<sup>1)</sup> Depends on mounting situation

## Resistance/ temperature characteristic

NTC resistance temperature curve

R/T-curve 8502  
 R at 25 °C 47000 [Ω]  
 B (25/100) 4000 [K] ±1.5 [%]  
 R<sub>N</sub> at 25 °C 47000 [Ω] ±3 [%]

Temp. [°C]	R Nom [Ω]	R Min [Ω]	R Max [Ω]	ΔR [±%]	ΔT [±°C]	α [%/K]
-55.0	4519400	4048100	4990800	10.4	1.4	7.4
-50.0	3143900	2835400	3452400	9.8	1.4	7.1
-45.0	2215000	2010600	2419300	9.2	1.3	6.9
-40.0	1579500	1442700	1716300	8.7	1.3	6.6
-35.0	1139400	1046900	1231900	8.1	1.3	6.4
-30.0	831020	767850	894200	7.6	1.2	6.2
-25.0	612510	568990	656020	7.1	1.2	6
-20.0	455990	425770	486210	6.6	1.1	5.8
-15.0	342740	321600	363880	6.2	1.1	5.6
-10.0	259980	245090	274860	5.7	1.1	5.4
-5.0	198930	188380	209470	5.3	1	5.3
0.0	153490	145980	161000	4.9	1	5.1
5.0	119380	114010	124750	4.5	0.9	4.9
10.0	93561	89710	97412	4.1	0.9	4.8
15.0	73864	71095	76633	3.7	0.8	4.7
20.0	58723	56731	60716	3.4	0.8	4.5
<b>25.0</b>	<b>47000</b>	<b>45590</b>	<b>48410</b>	<b>3</b>	<b>0.7</b>	<b>4.4</b>
30.0	37860	36579	39140	3.4	0.8	4.3
35.0	30685	29549	31821	3.7	0.9	4.1
40.0	25018	24013	26022	4	1	4
45.0	20513	19628	21398	4.3	1.1	3.9
50.0	16911	16132	17690	4.6	1.2	3.8
55.0	14015	13330	14700	4.9	1.3	3.7
60.0	11673	11071	12276	5.2	1.4	3.6
65.0	9770.1	9239.5	10301	5.4	1.5	3.5
70.0	8215.2	7747.9	8682.6	5.7	1.7	3.4
75.0	6938.8	6526.6	7350.9	5.9	1.8	3.3
80.0	5886	5522	6249.9	6.2	1.9	3.2
85.0	5013.6	4691.7	5335.6	6.4	2	3.2
90.0	4287.7	4002.5	4572.9	6.7	2.2	3.1
95.0	3681	3427.9	3934.1	6.9	2.3	3
100.0	3171.9	2946.9	3397	7.1	2.4	2.9
105.0	2743.1	2542.6	2943.5	7.3	2.5	2.9
110.0	2380.4	2201.5	2559.3	7.5	2.7	2.8
115.0	2072.6	1912.7	2232.5	7.7	2.8	2.7
120.0	1810.4	1667.2	1953.7	7.9	3	2.7
125.0	1586.3	1457.8	1714.9	8.1	3.1	2.6

## Reliability data

SMD NTC thermistors are tested in accordance with IEC 60068. The parts are mounted on a standardized PCB in accordance with IEC 60539-1.

Test	Standard	Test conditions	$\Delta R_{25} / R_{25}$ (typical)	Remarks
Storage in dry heat	IEC 60068-2-2 JIS C 0021	Storage at upper category temperature T: (125 ±2) °C t: 1000 h	<2%	
Storage in damp heat, steady state	IEC 60068-2-78 JIS C 0022	Temperature of air: (40 ±2) °C Relative humidity of air: (93 +2/-3)% under zero bias condition Duration: 56 days	<2%	
Rapid temperature cycling	IEC 60068-2-14 JIS C 0025	Lower test temperature: -55 °C Upper test temperature: 125 °C Number of cycles: 100	<2%	
Endurance	-	P <sub>max</sub> : 210 mW T: (65 ±2) °C t: 1000 h	<2%	
Solderability	IEC 60068-2-58 JIS C 0054	Solderability: (215 ±3) °C, (3 ±0.3) s (245 ±5) °C, (2 ±0.2) s  Resistance to soldering heat: (260 ±5) °C, (10 ±1) s		95% of termination wetted
Resistance drift after soldering	-	Reflow soldering profile Wave soldering profile	<1%	

## Mounting instructions

### 1. Termination

nickel barrier termination (AgNiSn)

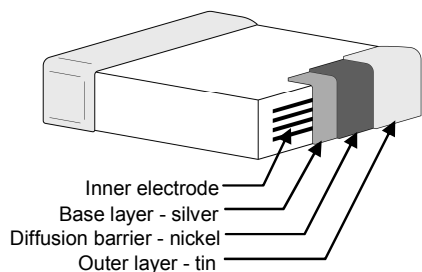

### 2. Recommended geometry of solder pads

Case size inch/mm	A [mm]	B [mm]	C [mm]
0805/2012	1.3	1.2	3.4

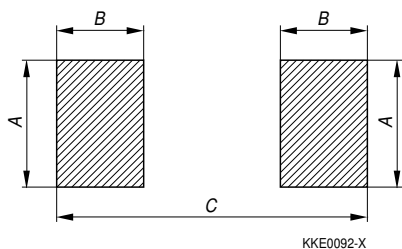

### 3. Requirements for Solderability

- Solderability (test to IEC 60068-2-58):

Preconditioning: Immersion into flux F-SW 32.

Evaluation criterion: Wetting of soldering areas  $\geq 95\%$ .

Solder	Bath temperature (°C)	Dwell time (s)
SnPb 60/40	215 $\pm 3$	3 $\pm 0.3$
SnAg (3.0 ... 4.0), Cu (0.5 ... 0.9)	245 $\pm 5$	3 $\pm 0.3$

- Resistance to soldering heat (test to IEC 60068-2-58):

Preconditioning: Immersion into flux F-SW 32.

Evaluation criterion: Leaching of side edges  $\leq 1/3$ .

Solder	Bath temperature (°C)	Dwell time (s)
SnPb 60/40	260 $\pm 5$	10 $\pm 1$
SnAg (3.0 ... 4.0), Cu (0.5 ... 0.9)	260 $\pm 5$	10 $\pm 1$

## 4. Recommended soldering profiles

### 4.1 Reflow soldering

Recommended temperature characteristic for reflow soldering following JEDEC J-STD-020D

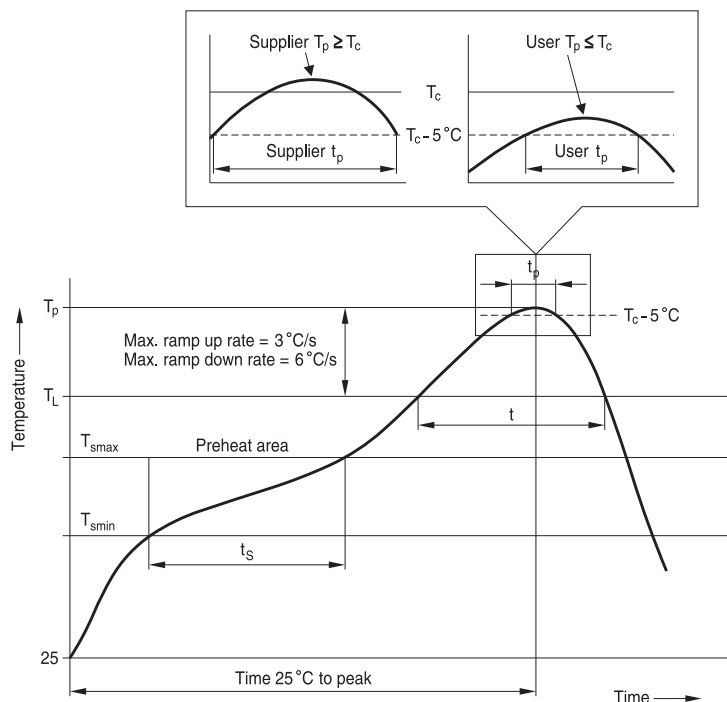

Profile feature		Sn-Pb eutectic assembly	Pb-free assembly
Preheat and soak			
- Temperature min	$T_{smin}$	100 °C	150 °C
- Temperature max	$T_{smax}$	150 °C	200 °C
- Time	$t_{smin}$ to $t_{smax}$	60 ... 120 s	60 ... 180 s
Average ramp-up rate	$T_{smax}$ to $T_p$	3 °C/s max.	3 °C/s max.
Liquidous temperature	$T_L$	183 °C	217 °C
Time at liquidous	$t_L$	60 ... 150 s	60 ... 150 s
Peak package body temperature	$T_p$ <sup>1)</sup>	220 °C ... 235 °C <sup>2)</sup>	245 °C ... 260 °C <sup>2)</sup>
Time ( $t_p$ ) <sup>3)</sup> within 5 °C of specified classification temperature ( $T_c$ )		20 s <sup>3)</sup>	30 s <sup>3)</sup>
Average ramp-down rate	$T_p$ to $T_{smax}$	6 °C/s max.	6 °C/s max.
Time 25 °C to peak temperature		maximum 6 min	maximum 8 min

1) Tolerance for peak profile temperature ( $T_p$ ) is defined as a supplier minimum and a user maximum.

2) Depending on package thickness. For details please refer to JEDEC J-STD-020D.

3) Tolerance for time at peak profile temperature ( $t_p$ ) is defined as a supplier minimum and a user maximum.

**Note:** All temperatures refer to topside of the package, measured on the package body surface.

## 4.2 Wave soldering profile

Temperature characteristic at component terminals with dual wave soldering

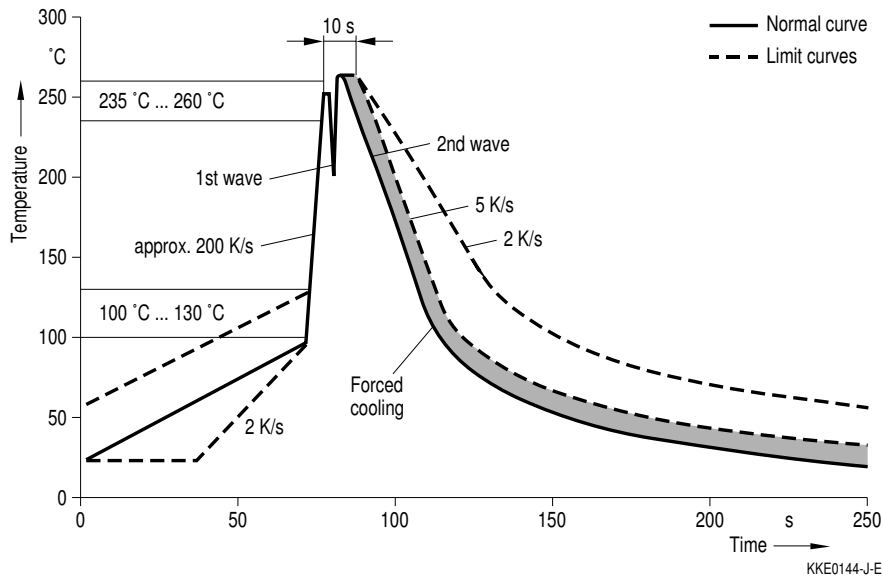

## 4.3 Recommended solder

Flux less Pb-free Sn (95.1 ... 96.0), Ag (3.0 ... 4.0), Cu (0.5 ... 0.9) solder is recommended.

## 5. Storage conditions

Solderability is guaranteed for 12 months from date of delivery for types with nickel barrier termination, provided that the components are stored in the original packages.

Storage temperature: -25 ... +45 °C

Relative humidity: <75% annual average, <95% on max. 30 days in a year, dew precipitation and wetness are inadmissible.

## Taping and packing

### 1. Taping

#### 1.1. Blister tape (taping to IEC 60286-3)

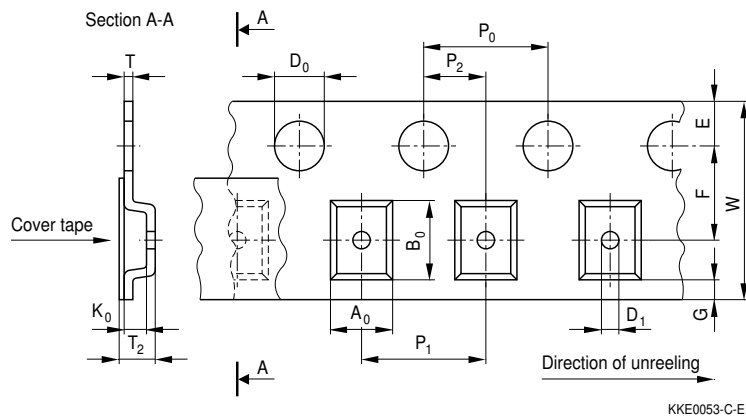

#### Dimensions (mm)

	Case size 0805 (8-mm tape)	Tolerance
$A_0 \times B_0$	1.60 x 2.40	$\pm 0.2$
$K_0$	1.40	max.
$T_2$	2.5	max.
$D_0$	1.50	$+0.10/-0$
$D_1$	1.00	min.
$P_0$	4.00	$\pm 0.10^{1)}$
$P_2$	2.00	$\pm 0.05$
$P_1$	4.00	$\pm 0.10$
$W$	8.00	$\pm 0.30$
$E$	1.75	$\pm 0.10$
$F$	3.50	$\pm 0.05$
$G$	0.75	min.

<sup>1)</sup>  $\leq 0.2$  mm over 10 sprocket holes.

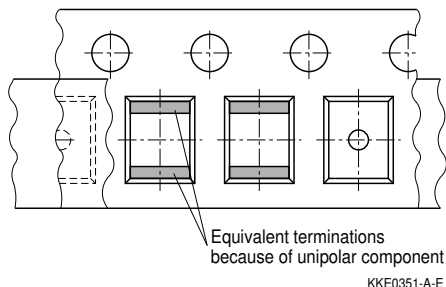

**Part orientation in tape pocket for blister tape**

**Additional taping information**

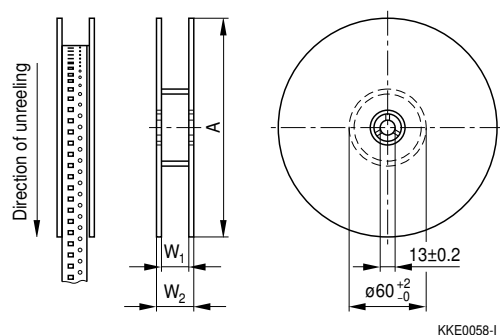
Reel material	Polystyrol (PS)
Tape material	Polystyrol (PS) or Polycarbonat (PC) or PVC
Tape break force	min. 10 N
Top cover tape strength	min. 10 N
Top cover tape peel force	0.2 to 0.6 N for 8-mm tape and 0.2 to 0.8 N for 12-mm tape ate a peel speed of 300 mm/min
Tape peel angle	Angle between top cover tape and the direction of feed during peel off: 165 to 180 °
Cavity play	Each part rests in the cavity so that the angle between the part and cavity centre line is no more than 20 °

**2. Reel packing**

Definition	Symbol	Dim. (mm)	Tol. (mm)
Reel diameter	A	180	-3/+0
Reel width (inside)	W <sub>1</sub>	8.4	+1.5/-0
Reel width (outside)	W <sub>2</sub>	14.4	max.

**Weight of loaded reel:** maximum 1.500 g

**Packing unit:** 4.000 pcs.

## Cautions and warnings

### Storage

- Store thermistors only in original packaging. Do not open the package before storage.
- Storage conditions in original packaging: storage temperature  $-25\text{ °C} \dots +45\text{ °C}$ , relative humidity  $\leq 75\%$  annual mean, maximum 95%, dew precipitation is inadmissible.
- Do not store SMDs where they are exposed to heat or direct sunlight. Otherwise, the packing material may be deformed or SMDs may stick together, causing problems during mounting.
- Avoid contamination of thermistors surface during storage, handling and processing.
- Avoid storage of thermistor in harmful environments like corrosive gases ( $\text{SO}_x$ , Cl etc.)
- After opening the factory seals, such as polyvinyl-sealed packages, use the SMDs as soon as possible.
- Solder thermistors after shipment from EPCOS within the time specified:  
SMD NTC thermistors with nickel-barrier termination: 12 months

### Handling

- NTC thermistors must not be dropped. Chip-offs must not be caused during handling of NTCs.
- Components must not be touched with bare hands. Gloves are recommended.
- Avoid contamination of thermistor surface during handling.
- Washing processes may damage the product due to the possible static or cyclic mechanical loads (e.g. ultrasonic cleaning). They may cause cracks to develop on the product and its parts, which might lead to reduced reliability or lifetime.

### Soldering

- Use resin-type flux or non-activated flux.
- Insufficient preheating may cause ceramic cracks.
- Rapid cooling by dipping in solvent is not recommended.
- Complete removal of flux is recommended.

## Mounting

- When NTC thermistors are encapsulated with sealing material or over molded with plastic material, there must be no mechanical stress caused by thermal expansion during the production process (curing / over molding process) and during later operation. The upper category temperature of the thermistor must not be exceeded. Ensure that the materials used (sealing compound and plastic material) are chemically neutral.
- Electrode must not be scratched before/during/after the mounting process.
- Contacts and housing used for assembly with thermistor have to be clean before mounting.
- Ensure that adjacent materials are designed for operation at temperatures comparable to the surface temperature of the thermistor. Be sure that surrounding parts and materials can withstand the temperature.
- Avoid contamination of thermistor surface during processing.

## Operation

- Use thermistors only within the specified operating temperature range.
- Environmental conditions must not harm the thermistors. Use thermistors only in normal atmospheric conditions.
- Contact of NTC thermistors with any liquids and solvents should be prevented. It must be ensured that no water enters the NTC thermistors (e.g. through plug terminals). For measurement purposes (checking the specified resistance vs. temperature), the component must not be immersed in water but in suitable liquids (e.g. Galden).
- Avoid dewing and condensation.
- Be sure to provide an appropriate fail-safe function to prevent secondary product damage caused by malfunction (e.g. use VDR for limitation of overvoltage condition).

## Important notes

The following applies to all products named in this publication:

1. Some parts of this publication contain **statements about the suitability of our products for certain areas of application**. These statements are based on our knowledge of typical requirements that are often placed on our products in the areas of application concerned. We nevertheless expressly point out **that such statements cannot be regarded as binding statements about the suitability of our products for a particular customer application**. As a rule, EPCOS is either unfamiliar with individual customer applications or less familiar with them than the customers themselves. For these reasons, it is always ultimately incumbent on the customer to check and decide whether an EPCOS product with the properties described in the product specification is suitable for use in a particular customer application.
2. We also point out that **in individual cases, a malfunction of electronic components or failure before the end of their usual service life cannot be completely ruled out in the current state of the art, even if they are operated as specified**. In customer applications requiring a very high level of operational safety and especially in customer applications in which the malfunction or failure of an electronic component could endanger human life or health (e.g. in accident prevention or lifesaving systems), it must therefore be ensured by means of suitable design of the customer application or other action taken by the customer (e.g. installation of protective circuitry or redundancy) that no injury or damage is sustained by third parties in the event of malfunction or failure of an electronic component.
3. **The warnings, cautions and product-specific notes must be observed.**
4. In order to satisfy certain technical requirements, **some of the products described in this publication may contain substances subject to restrictions in certain jurisdictions (e.g. because they are classed as hazardous)**. Useful information on this will be found in our Material Data Sheets on the Internet ([www.epcos.com/material](http://www.epcos.com/material)). Should you have any more detailed questions, please contact our sales offices.
5. We constantly strive to improve our products. Consequently, **the products described in this publication may change from time to time**. The same is true of the corresponding product specifications. Please check therefore to what extent product descriptions and specifications contained in this publication are still applicable before or when you place an order. We also **reserve the right to discontinue production and delivery of products**. Consequently, we cannot guarantee that all products named in this publication will always be available. The aforementioned does not apply in the case of individual agreements deviating from the foregoing for customer-specific products.
6. Unless otherwise agreed in individual contracts, **all orders are subject to the current version of the “General Terms of Delivery for Products and Services in the Electrical Industry” published by the German Electrical and Electronics Industry Association (ZVEI)**.
7. The trade names EPCOS, BAOKE, Alu-X, CeraDiode, CeraLink, CSMP, CSSP, CTVS, DeltaCap, DigiSiMic, DSSP, FilterCap, FormFit, MiniBlue, MiniCell, MKD, MKK, MLSC, MotorCap, PCC, PhaseCap, PhaseCube, PhaseMod, PhiCap, SIFERRIT, SIFI, SIKOREL, SilverCap, SIMDAD, SiMic, SIMID, SineFormer, SIOV, SIP5D, SIP5K, ThermoFuse, WindCap are **trademarks registered or pending** in Europe and in other countries. Further information will be found on the Internet at [www.epcos.com/trademarks](http://www.epcos.com/trademarks).