

G1G146-BA07-52

EC centrifugal fan

forward curved, single inlet
with housing (flange)



ebm-papst Mulfingen GmbH & Co. KG

Bachmühle 2 · D-74673 Mulfingen

Phone +49 7938 81-0

Fax +49 7938 81-110

info1@de.ebmpapst.com

www.ebmpapst.com

Limited partnership · Headquarters Mulfingen
County court Stuttgart · HRA 590344

General partner Elektrobau Mulfingen GmbH · Headquarters Mulfingen
County court Stuttgart · HRB 590142

Nominal data

Type	G1G146-BA07-52	
Motor	M1G074-BF	
Nominal voltage	VDC	24
Nominal voltage range	VDC	16 .. 28
Type of data definition		fa
Speed	min ⁻¹	2200
Power input	W	100
Current draw	A	5.0
Min. ambient temperature	°C	- 25
Max. ambient temperature	°C	+60

ml = Max. load · me = Max. efficiency · fa = Running at free air · cs = Customer specs · cu = Customer unit
Subject to alterations



G1G146-BA07-52

EC centrifugal fan

forward curved, single inlet

with housing (flange)

Technical features

Mass	2.8 kg
Size	146 mm
Material of impeller	Sheet steel, galvanised
Housing material	Die-cast aluminium
Direction of rotation	Clockwise, seen on rotor
Type of protection	IP 42
Insulation class	"B"
Humidity class	F0
Max. permissible ambient motor temp. (transp./ storage)	+80 °C
Min. permissible ambient motor temp. (transp./storage)	-40 °C
Mounting position	Any
Condensate discharge holes	None
Operation mode	S1
Motor bearing	Ball bearing
Technical features	- Tach output - Motor current limit - Soft start - Control input 0-10 VDC / PWM
EMC interference immunity	Acc. to EN 61000-6-2 (industrial environment)
EMC interference emission	Acc. to EN 55022 (Class B)
Motor protection	Reverse polarity and locked-rotor protection
Cable exit	Axial
Product conforming to standard	EN 60950-1
Approval	UL 1004-1; GOST; CSA C22.2 Nr.77



EC centrifugal fan

forward curved, single inlet
with housing (flange)

Product drawing

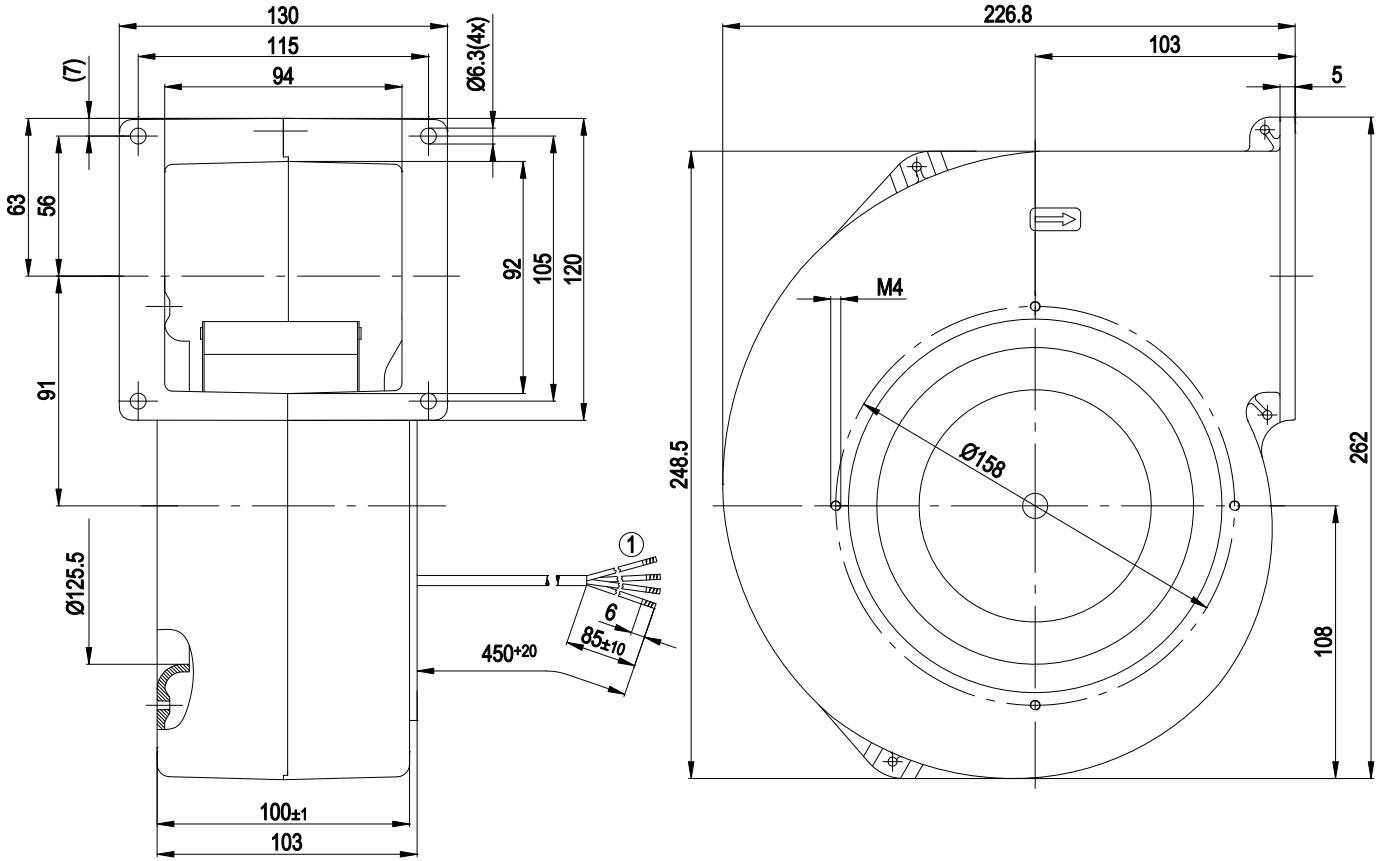

1 Connection line AWG20; 4 x brass lead tips crimped



EC centrifugal fan

forward curved, single inlet
with housing (flange)

Connection screen

Customer circuit

Full speed

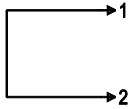

Adjustable speed

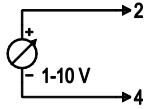

10 V → n = max
1 V → n = min
<1 V → n = 0
Safe start at
Unom -30%
from 4 V Ucontr.

Speed adjustable via potentiometer

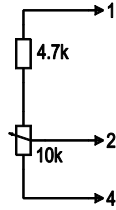

Speed adjustable via PWM 1-10 kHz

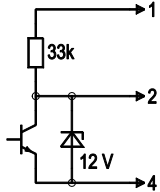

100% PWM → n = max
10% PWM → n = min
<10% PWM → n = 0
Safe start at
Unom -30%
from 40% PWM

Preset target value via temperature controller

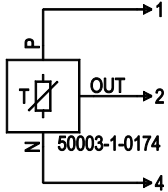

T < 10 °C → n = 0
T > 45 °C → n = max

Connection

Fan/Motor

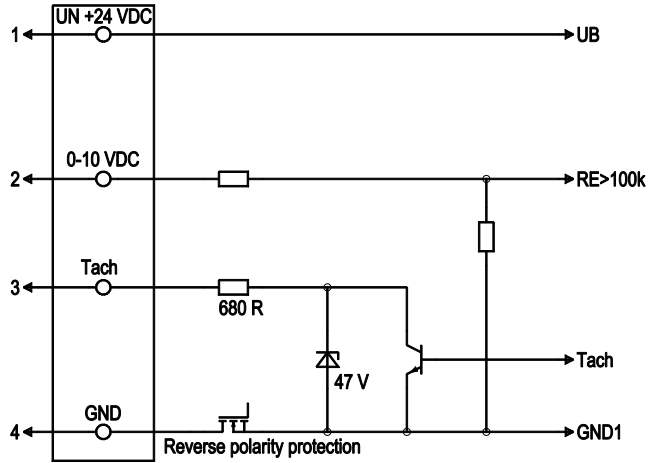

Line	No.	Signal	Colour	Function / assignment
1	1	Un +24 VDC	red	Power supply 24 VDC, residual ripple 3.5 %
1	2	0-10 VDC	yellow	Control input Re > 100 K
1	3	Tach	white	Speed monitoring output, 3 pulses per revolution, Isink max = 10 mA
1	4	GND	blue	Reference mass



Charts: Air flow

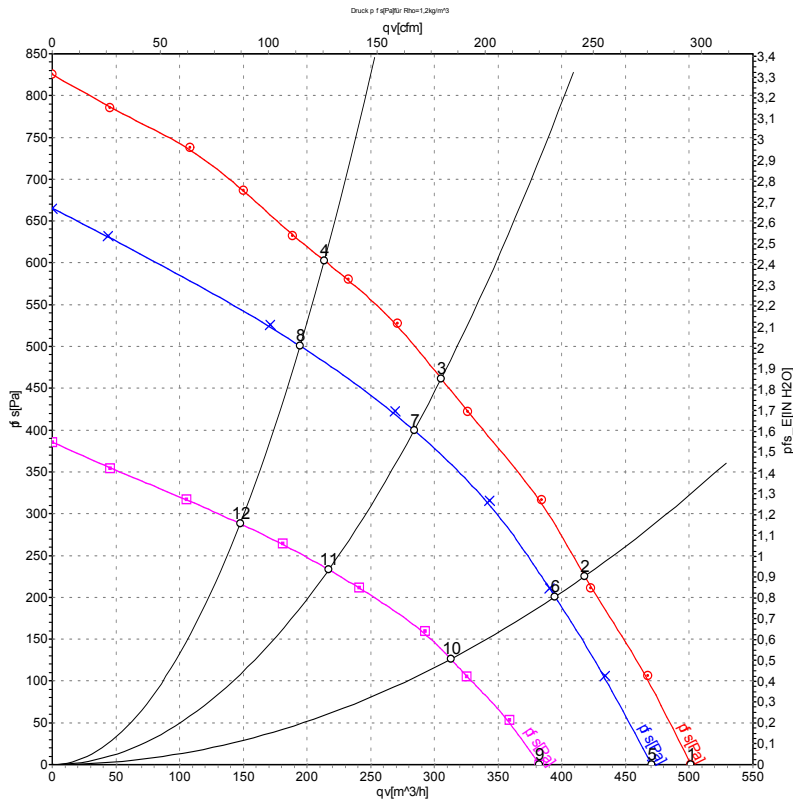

Measurement: LU-49675
 Measurement: LU-49674
 Measurement: LU-49676

Air performance measured as per ISO 5801 Installation category A. For detailed information on the measuring set-up, please contact ebm-papst. Suction-side noise levels: L_{WA} measured as per ISO 13347 / L_{pA} measured with 1m distance to fan axis. The values given are valid under the measuring conditions mentioned above and may vary according to the actual installation situation. With any deviation from the standard set-up, the specific values have to be checked and reviewed with the unit installed.

Measured values

	U	n	P _{ed}	I	qv	p _{fs}
	V	min ⁻¹	W	A	m ³ /h	Pa
1	28	2350	124	5.54	500	0
2	28	2585	118	5.03	420	224
3	28	2955	110	4.48	305	461
4	28	3275	101	4.00	215	603
5	24	2200	100	5.00	470	0
6	24	2425	98	4.67	395	200
7	24	2745	88	4.09	285	400
8	24	3000	76	3.49	195	500
9	16	1810	56	3.90	380	0
10	16	1950	50	3.45	315	126
11	16	2140	42	2.90	215	233
12	16	2295	36	2.55	150	288

U = Supply voltage · n = Speed · P_{ed} = Power input · I = Current draw · qv = Air flow · p_{fs} = Pressure increase

