

G1G120-AB67-02

EC centrifugal fan

forward curved, single inlet
with housing (flange)



ebm-papst Mulfingen GmbH & Co. KG

Bachmühle 2 · D-74673 Mulfingen

Phone +49 7938 81-0

Fax +49 7938 81-110

info1@de.ebmpapst.com

www.ebmpapst.com

Limited partnership · Headquarters Mulfingen
County court Stuttgart · HRA 590344

General partner Elektrobau Mulfingen GmbH · Headquarters Mulfingen
County court Stuttgart · HRB 590142

Nominal data

Type	G1G120-AB67-02	
Motor	M1G055-BD	
Nominal voltage	VDC	24
Nominal voltage range	VDC	16 .. 28
Type of data definition		fa
Speed	min ⁻¹	2200
Power input	W	40
Current draw	A	1.9
Min. ambient temperature	°C	-25
Max. ambient temperature	°C	60

ml = Max. load · me = Max. efficiency · fa = Running at free air · cs = Customer specs · cu = Customer unit
Subject to alterations



EC centrifugal fan

forward curved, single inlet

with housing (flange)

Technical features

Mass	1.57 kg
Size	120 mm
Surface of rotor	Thick layer passivated
Material of impeller	Sheet steel, hot-galvanised
Housing material	Die-cast aluminium
Direction of rotation	Clockwise, seen on rotor
Type of protection	IP 22
Insulation class	"B"
Humidity class	F0
Max. permissible ambient motor temp. (transp./ storage)	+ 80 °C
Min. permissible ambient motor temp. (transp./storage)	- 40 °C
Mounting position	Any
Condensate discharge holes	None
Operation mode	S1
Motor bearing	Ball bearing
Technical features	<ul style="list-style-type: none"> - Control input 0-10 VDC / PWM - Tach output - Motor current limit - Soft start
EMC interference immunity	Acc. to EN 61000-6-2 (industrial environment)
EMC interference emission	Acc. to EN 61000-6-3 (household environment)
Motor protection	Reverse polarity and locked-rotor protection
Cable exit	Axial
Product conforming to standard	EN 60950-1
Approval	CSA C22.2 Nr.77; EAC; UL 1004-1



G1G120-AB67-02

EC centrifugal fan

forward curved, single inlet
with housing (flange)

Product drawing

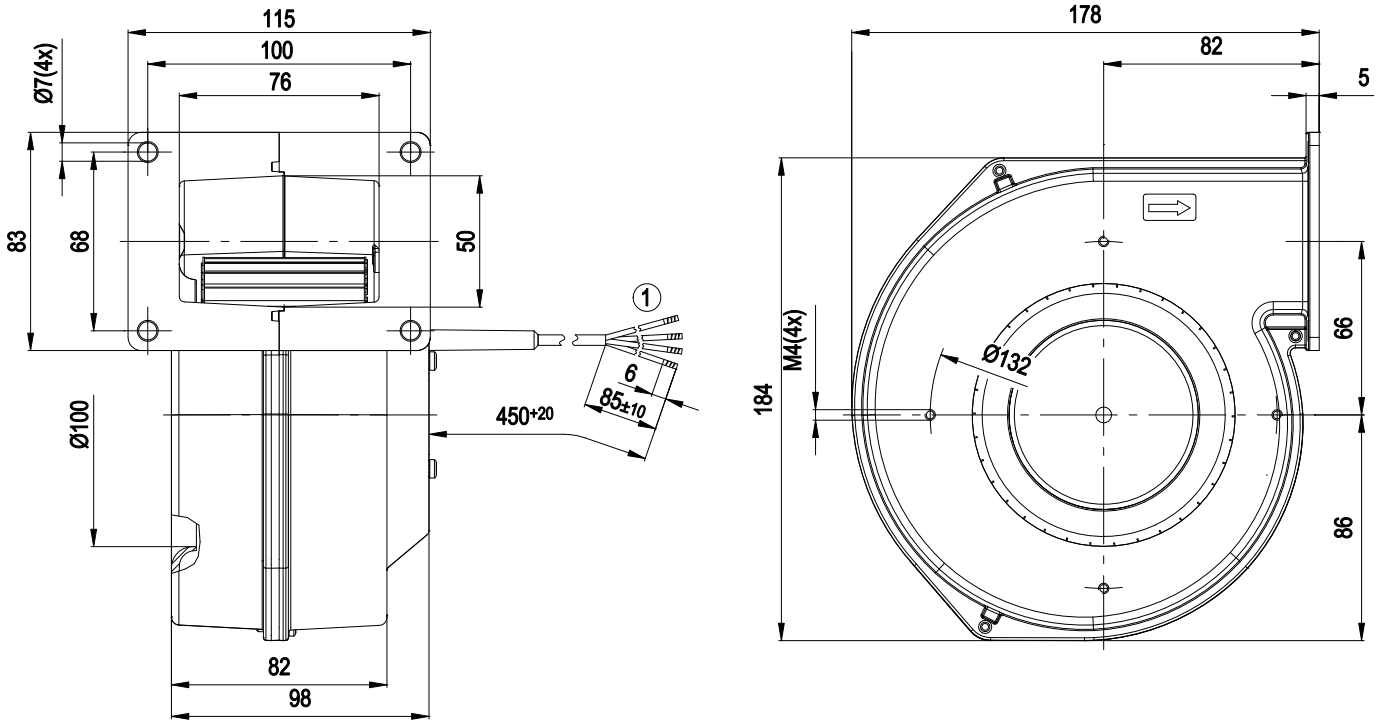

1 Connection line AWG20, 4x brass lead tips crimped



EC centrifugal fan

forward curved, single inlet
with housing (flange)

Connection screen

Customer circuit

Full speed

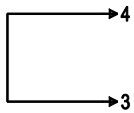

Speed setting

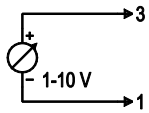

10 V → n = max
1 V → n = min
<1 V → n = 0
Safe start-up at Unom -30 %
from 4 V Ucontr.

Speed setting with fixed resistance

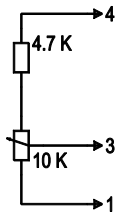

Speed setting via PWM 1-10 kHz

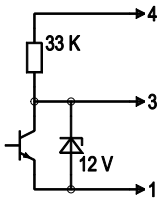

100 % PWM → n = max
10 % PWM → n = min
<10 % PWM → n = 0
Safe start-up at Unom -30 %
from 40 % PWM

Setting of values via temperature controller

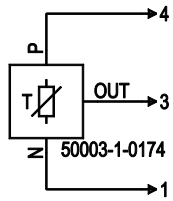

Connection

Fan / motor

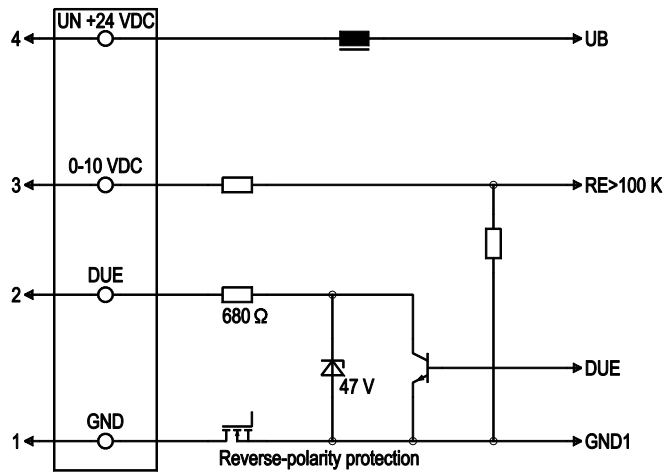

No.	Conn.	Designation	Colour	Function / assignment
1	1	GND	blue	Reference mass
1	2	Tach	white	Speed monitoring output, 2 pulses per rotation, Isink max = 10 mA
1	3	0-10 VDC	yellow	Control input Re > 100 K
1	4	Un +24 VDC	red	Power supply 24 VDC, residual ripple 3.5 %



EC centrifugal fan

forward curved, single inlet

with housing (flange)

Charts: Air flow

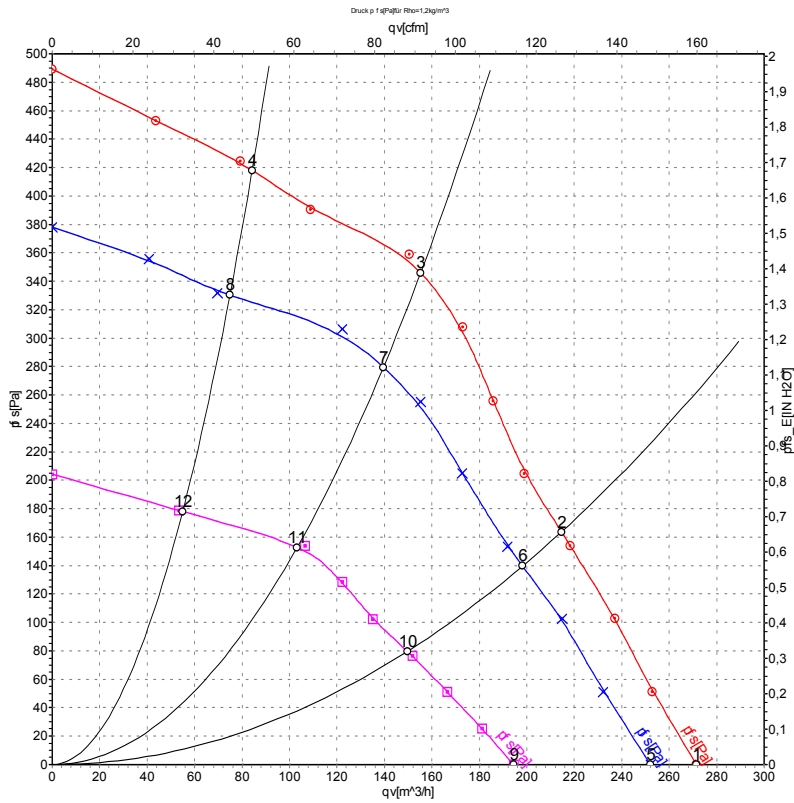

Measurement: LU-48521
 Measurement: LU-48520
 Measurement: LU-48522

Air performance measured as per ISO 5801 Installation category A. For detailed information on the measuring set-up, please contact ebmpapst. Suction-side noise levels: L_{wA} measured as per ISO 13347 / L_{pA} measured with 1m distance to fan axis. The values given are valid under the measuring conditions mentioned above and may vary according to the actual installation situation. With any deviation from the standard set-up, the specific values have to be checked and reviewed with the unit installed.

Measured values

	U	n	P _{ed}	I	qv	p _{fs}
	V	min ⁻¹	W	A	m ³ /h	Pa
1	28	2380	49	2.09	270	0
2	28	2675	45	1.82	215	164
3	28	3025	39	1.54	155	348
4	28	3315	31	1.23	85	418
5	24	2200	40	1.90	250	0
6	24	2480	36	1.64	200	140
7	24	2730	29	1.34	140	280
8	24	2940	24	1.10	75	330
9	16	1750	19	1.32	195	0
10	16	1895	16	1.11	150	80
11	16	2050	13	0.92	105	155
12	16	2215	9.9	0.78	55	178

U = Supply voltage · n = Speed · P_{ed} = Power input · I = Current draw · qv = Air flow · p_{fs} = Pressure increase

