

Product Data Sheet 4114 N/17HH-218

ebmpapst

The engineer's choice



4114 N/17HH-218

INDEX

1	General	3
2	Mechanics	3
2.1	General	3
2.2	Connections	3
3	Operating Data	4
3.1	Electrical Operating Data	4
3.2	Electrical Interface - Output - Alarm.....	5
3.3	Electrical Features	6
3.4	Aerodynamics	7
3.5	Sound Data	8
4	Environment.....	8
4.1	General	8
4.2	Climatic Requirements.....	8
5	Safety.....	9
5.1	Electrical Safety	9
5.2	Approval Tests	9
6	Reliability.....	9
6.1	General	9

1 General

Fan type	Fan	
Rotating direction looking at rotor	Clockwise	
Airflow direction	Air intake over struts	
Bearing system	Ball bearing	
Mounting position - shaft	Any	

2 Mechanics

2.1 General

Width	119,0 mm	
Height	119,0 mm	
Depth	38,0 mm	
Mass	0,390 kg	
Housing material	Metal	
Impeller material	Plastic	
Max. torque when mounted across both mounting flanges	Wire outlet corner: 420 Ncm Remaining corners: 600 Ncm	
Screw size	ISO 4762 - M4 degreased, without an additional brace and without washer	

2.2 Connections

Electrical connection	Wires	
Lead wire length	L = 995 mm	
Tolerance	+ - 10,0 mm	
Wire size (AWG)	22	
Insulation diameter	1,70 mm	

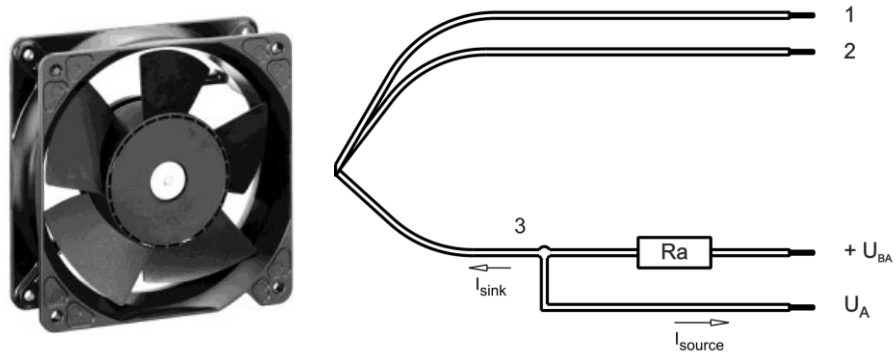

Wire	Color	Operation
1	red	+ UB
2	blue	- GND
3	white	Alarm

The auxiliaries shown on the schematic diagram (which are required for the intended use) are not part of our delivery.

3 Operating Data

3.1 Electrical Operating Data

Measurement conditions: Normal air density = 1,2 kg/m³; Temperature 23°C +/- 3°C; Motor axis horizontal; warm-up time before measuring 5 minutes (unless otherwise specified). In the intake and outlet area should not be any solid obstruction within 0,5 m.

$\Delta p = 0$: corresp. to free air flow (see section 3.5)
I: corresp. to arithm. mean current value

Features	Condition	Symbol	Values		
Voltage range		U	18 V		28 V
Nominal voltage		U_N		24 V	
Power consumption	$\Delta p = 0$	P	8 W	12 W	12,9 W
Tolerance	0010		+/- 17,5 %	+/- 12,5 %	+/- 15 %
Current consumption	$\Delta p = 0$	I	445 mA	510 mA	460 mA
Tolerance	0010		+/- 17,5 %	+/- 12,5 %	+/- 15 %
Speed	$\Delta p = 0$	n	4.250 1/min	5.000 1/min	5.030 1/min
Tolerance	0010		+/- 12,5 %	+/- 7,5 %	+/- 10 %
Starting current consumption				800 mA	

3.2 Electrical Interface - Output - Alarm

Alarm type	/17 (high = ok, open collector)
------------	---------------------------------

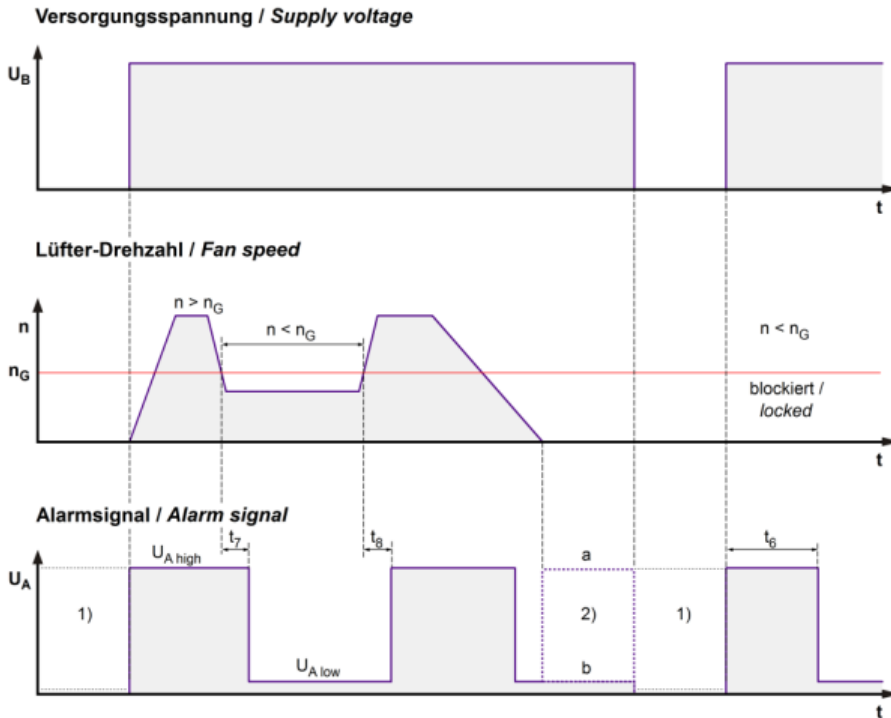

$$R_a = \frac{U_{BA} - U_{A\text{low}}}{I_{\text{sink}}}$$

Lüfter / Fan Kunde / Customer

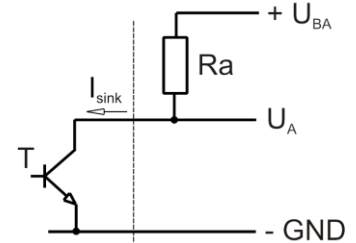

- 1) Wenn der Lüfter abgeschaltet ist, hängt der Zustand des Ausgangssignals U_A von der Kundenapplikation ab.
 When the fan is powered off, the output signal U_A depends on the customer's application.
- 2) Für den gültigen Zustand (a oder b) siehe Alarmunterdrückung in der Tabelle.
 For the valid condition (a or b) see alarm suppression in the table.

Features	Note	Values
Alarm operating voltage	U_{BA}	Min.: 4,5 V Max.: 40 V
Alarm signal Low	$U_{A\text{low}}$	I_{sink} : 20 mA < 1 V
Alarm signal High	$U_{A\text{high}}$	I_{source} : 15 V
Leakage current		50 μ A
External resistor	External resistor R_a from U_{BA} to U_A required. All voltage measured to GND.	
Alarm start-up delay time	t_6	≤ 10 s +/- 0,5 s
Tolerance		
Alarm trip speed limit	n_G	1.550 1/min +/- 100 1/min
Tolerance		
Alarm at sense failure	No	
Alarm latch	No	
Alarm isolated from motor	No	

Alarm start-up delay time t_2 when switch-on the fan.
 During operation is $t_2 = 0$ s.

3.3 Electrical Features

Electronic function	Speed-Controlled	
Reversed polarity protection	Rectifying diode	
Max. residual current at U_N	$I_F \leq 10 \text{ mA}$	
Locked rotor protection	Auto restart	
Locked rotor current at U_N	I_{block} approx. 1.000 mA	
Clock signal at locked rotor	t_3 / t_4 typical: 0,5 s / 5 s	

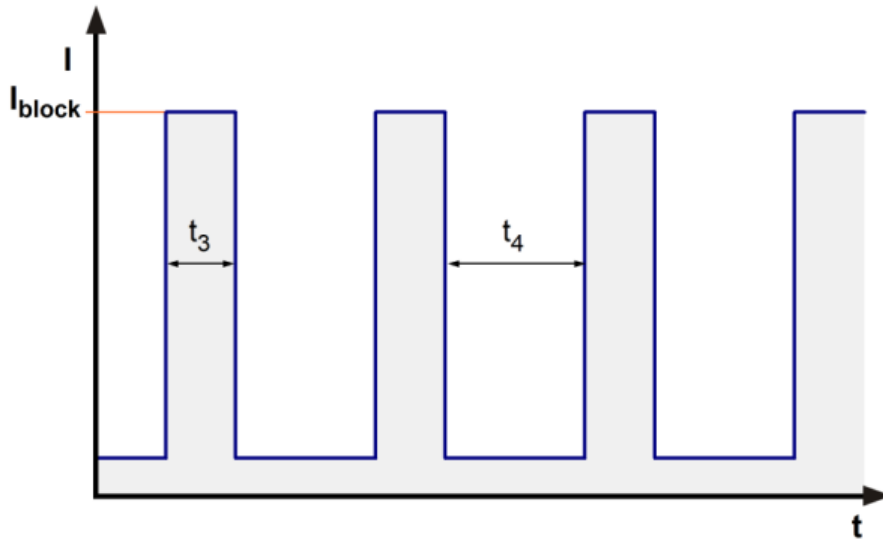

3.4 Aerodynamics

Measurement conditions: Measured with a double chamber intake rig acc. to DIN EN ISO 5801.
 Normal air density = 1,2 kg/m³; Temperature 23°C +/- 3°C;
 In the intake and outlet area should not be any solid obstruction within 0,5 m.
 The information is only valid under the specified test conditions and may be changed by the installation conditions. If there are deviations from the standard test conditions, the characteristic values must be checked under the installed conditions.

a.) Operation condition:

5.000 1/min at free air flow

Max. free-air flow ($\Delta p = 0 / \dot{V} = \text{max.}$)	260,0 m ³ /h	
Max. static pressure ($\Delta p = \text{max.} / \dot{V} = 0$)	250 Pa	

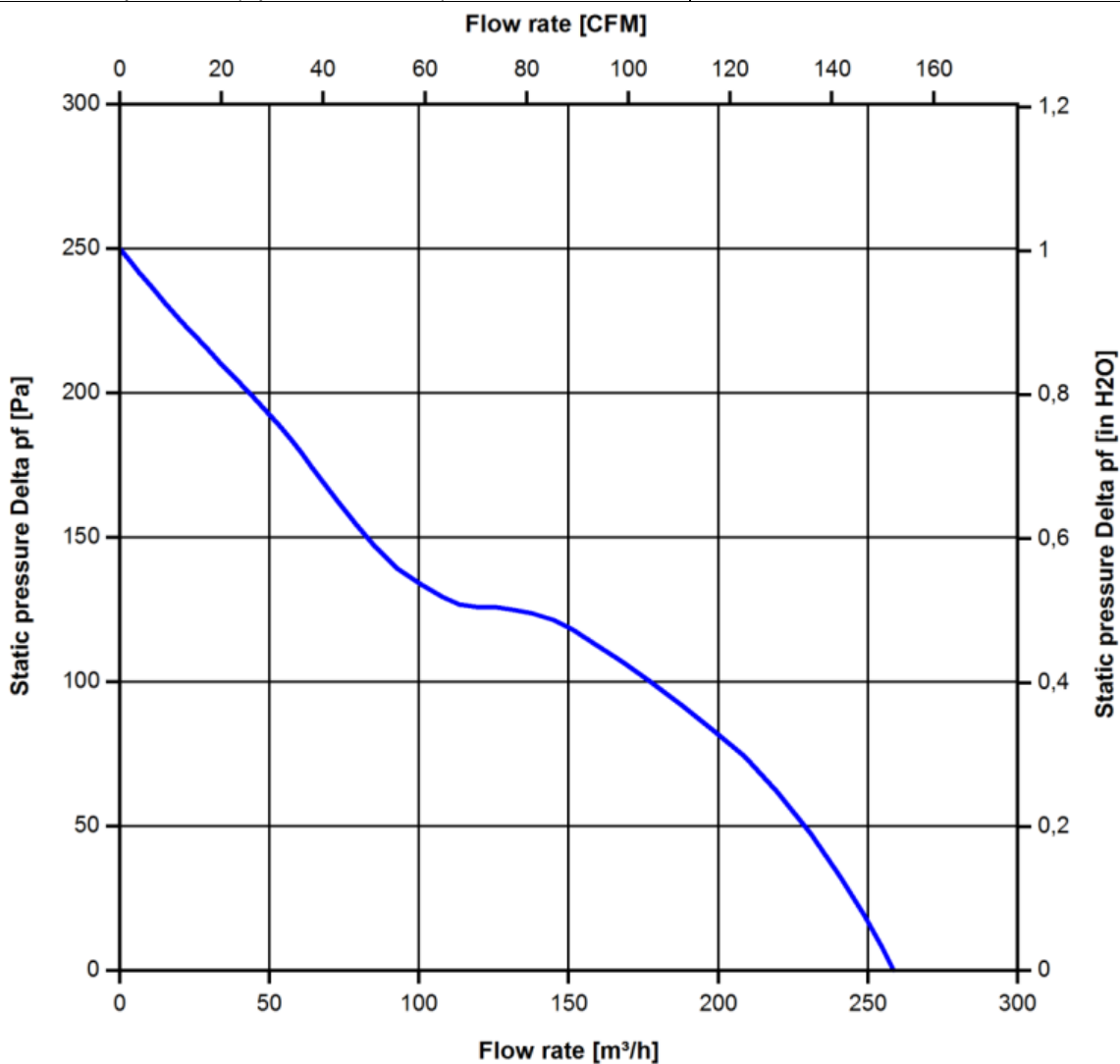

3.5 Sound Data

Measurement conditions: Sound pressure level: 1 meter distance between microphone and the air intake.
 Sound power level: Acc. to DIN 45635 part 38 (ISO 10302)
 Measured in a semianchoic chamber with a background noise level of $L_p(A) < 5 \text{ dB(A)}$
 For further measurement conditions see section 3.5

a.) Operation condition:

5.000 1/min at free air flow

Optimal operating point	160,0 m ³ /h @ 100 Pa	
Sound power level at the optimal operating point	6,7 bel(A)	
Sound pressure level at free air flow, measured in rubber bands	60,0 dB(A)	

4 Environment

4.1 General

Min. permitted ambient temperature TU min.	-20 °C	
Max. permitted ambient temperature TU max.	55 °C	
Min. permitted storage temperature TL min.	-40 °C	
Max. permitted storage temperature TL max.	80 °C	

4.2 Climatic Requirements

Humidity requirements	humid heat, constant; according to DIN EN 60068-2-78, 14 days	
Water exposure	None	
Dust requirements	None	
Salt fog requirements	None	

Permitted application area:

The product is intended for use in sheltered rooms with controlled temperature and controlled humidity. Directly exposure to water must be avoided.

Pollution degree 1 (according DIN EN 60664-1)

There is either no pollution or it occurs only dry, non-conductive pollution. The pollution has no negative impact. Please require severity levels and specification parameters from the responsible development departments.

5 Safety

5.1 Electrical Safety

Dielectric strength DIN EN 60950 (VDE 0805) and DIN EN 60335 (VDE 0700) A.) Type test Measuring conditions: After 48h of storage at 95% R.H. and 25°C. No arcing or breakdown is allowed! All connections together to ground.	500 VAC / 1 Min.	
B.) Routine test Measuring conditions: At indoor climate. No arcing or breakdown is allowed! All connections together to ground.	500 VAC / 1 Sec.	
Isolation resistance Measuring conditions: After 48h of storage at 95% R.H. and 25°C measured with U=500 VDC for 1 min.	RI > 10 MOhm	
Clearance / creepage distance	1,0 mm / 1,2 mm	
Protection class	III	

5.2 Approval Tests

CE	EC Declaration of Conformity	Yes
EAC	Eurasian Conformity	Yes
UL	Underwriters Laboratories	Yes / UL507, Electric Fans
VDE	Association for Electrical, Electronic and Information Technologies	Yes / Approval acc. to EN 60950 (VDE 0805) - Information technology equipment
CSA	Canadian Standards Association	Yes / C22.2 No. 113 Fans and Ventilators
CCC	China Compulsory Certification	Not applicable

6 Reliability

6.1 General

Life expectancy L10 at TU = 40 °C	70.000 h	
Life expectancy L10 at TU max.	50.000 h	
Life expectancy L10 acc. to IPC 9591 at TU = 40 °C	117.500 h	

Copying of this document, and giving it to others and the use or communication of the contents thereof, are forbidden without express authority. Offenders are liable to the payment of damages. All rights are reserved in the event of the grant of a patent or the registration of a utility model or design.

Schutzvermerk nach DIN ISO 16016 beachten/
Refer to protection notice DIN ISO 16016!

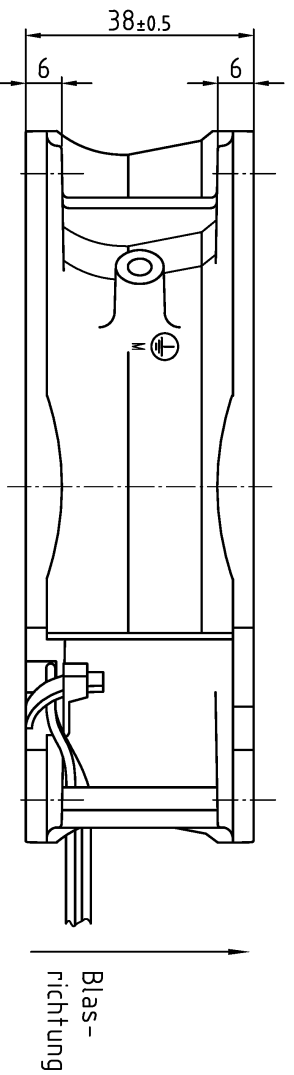
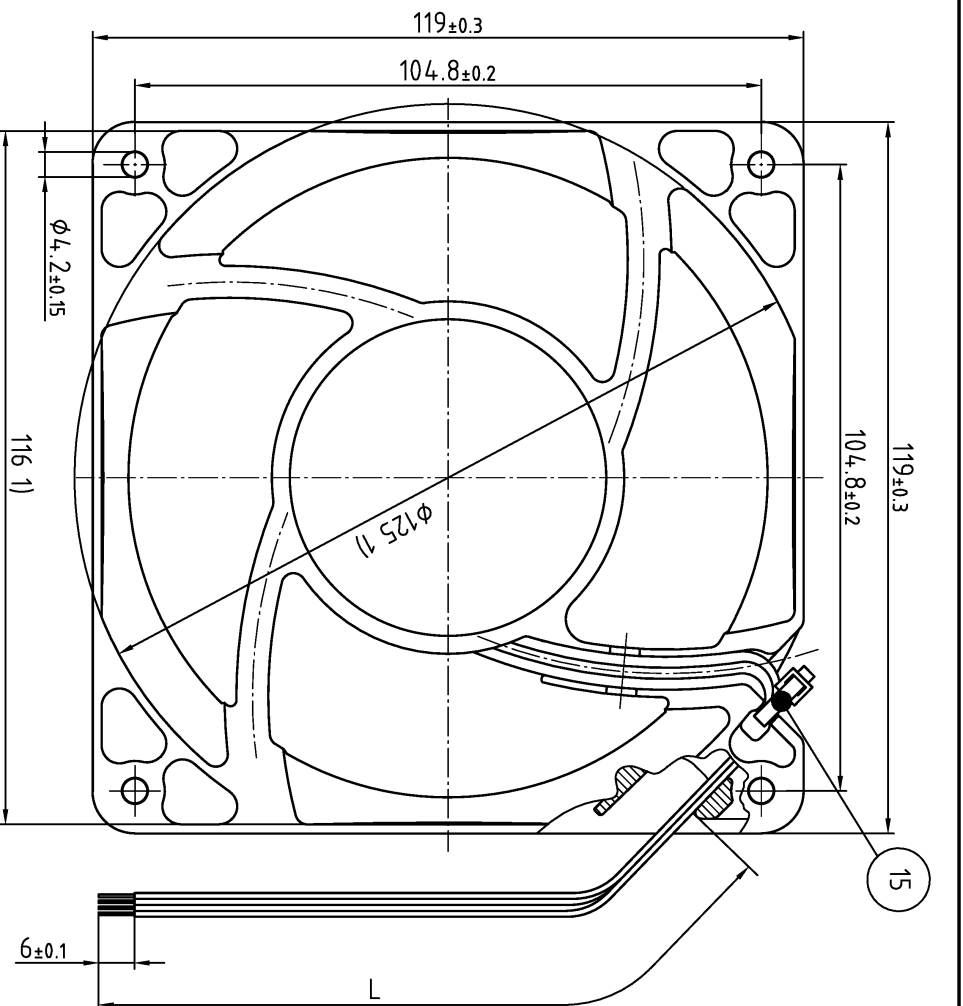

Axialspiel bei
- Kugellagerung (K): 0 mit Federausgleich
1) Maße für Montagewand

Sitz-Status/State		Aend.-Nr./Change-Nr.		eblmpapst		Werkstoff/Material:		Volumen/Volume (mm ³)	
AutCAD-System-Version		Datei/Date		CAD-Umgebung/ CAD-Environment		Name/Name		Gewicht/Mass (g):	
Bearb./ Drawn		gepr./ Checked		Freig./ Released		Artikel-/Title			
Tolerierung/Tolerances:		Allgemeintoleranzen/Gen. tolerances		Zdng.-Nr./ Drawing-No.:		Ers./Zdng./Replaces:			
				eblmpapst					
		eblmpapst St. Georgen GmbH & Co. KG		Dokumenttyp/Type of Document		Teildokument Blatt/Page		Index/Index	
				Formal/Size		Massstab/Scale			