



The engineer's choice

ebmpapst

INDEX

1	General	3
2	Mechanics	3
2.1	General	3
2.2	Connections	3
3	Operating Data	5
3.1	Operating Data - Electrical Interface - Input	5
3.2	Electrical Operating Data	7
3.3	Operating Data - Electrical Interface -Output	8
3.4	Electrical Features	9
3.5	Aerodynamic	10
3.6	Sound Data	11
4	Environment	11
4.1	General	11
4.2	Climatic requirements*)	11
4.3	Mechanical requirements.....	12
5	Safety	13
5.1	Electrical Safety	13
5.2	Approval Tests	13
6	Reliability	13
6.1	General	13

1 General

Fan type	Fan	
Rotational direction looking at rotor	clockwise	
Airflow direction	Air outlet over struts	
Bearing system	Ball bearing	
Mounting position	any	

2 Mechanics

2.1 General

Width	92,0 mm	
Height	92,0 mm	
Depth	38,0 mm	
Weight	0,25 kg	
Housing material	Plastic	
Impeller material	Plastic	
Max. torque when mounted across both mounting flanges	wire outlet corner: 50 Ncm remaining corners: 110 Ncm	
Screw size	ISO 4762 - M4 degreased, without an additional brace and without washer	

2.2 Connections

Electrical connection	Wires	
Length of lead wire	L = 310 mm	
Tolerance	+ - 10,0 mm	
Wire gauge (AWG)	22	
Insulation diameter	1,7 mm	
Contact	see drawing	

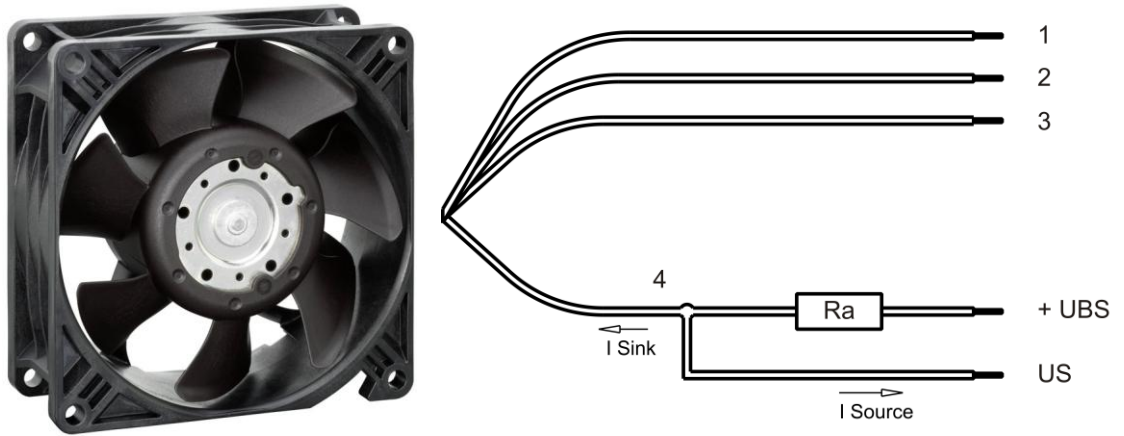

	Colour	Operation
Wire 1	red	+ UB
Wire 2	blue	- GND
Wire 3	violet	PWM
Wire 4	white	Tacho

The auxiliaries shown on the schematic diagram (which are required for the intended use) are not part of our delivery.

3 Operating Data

3.1 Operating Data - Electrical Interface - Input

Control input	PWM
---------------	-----

Features

Inpute type	Open collector	
PWM - Frequency		1 kHz - 30 kHz Typical: 25 kHz
Max. voltage for logic "Low"		0,2 V
Maximum source current	short circuit current	≤ 1 mA
Typical time until warm restart	After shutdown by PWM	~ 9 s

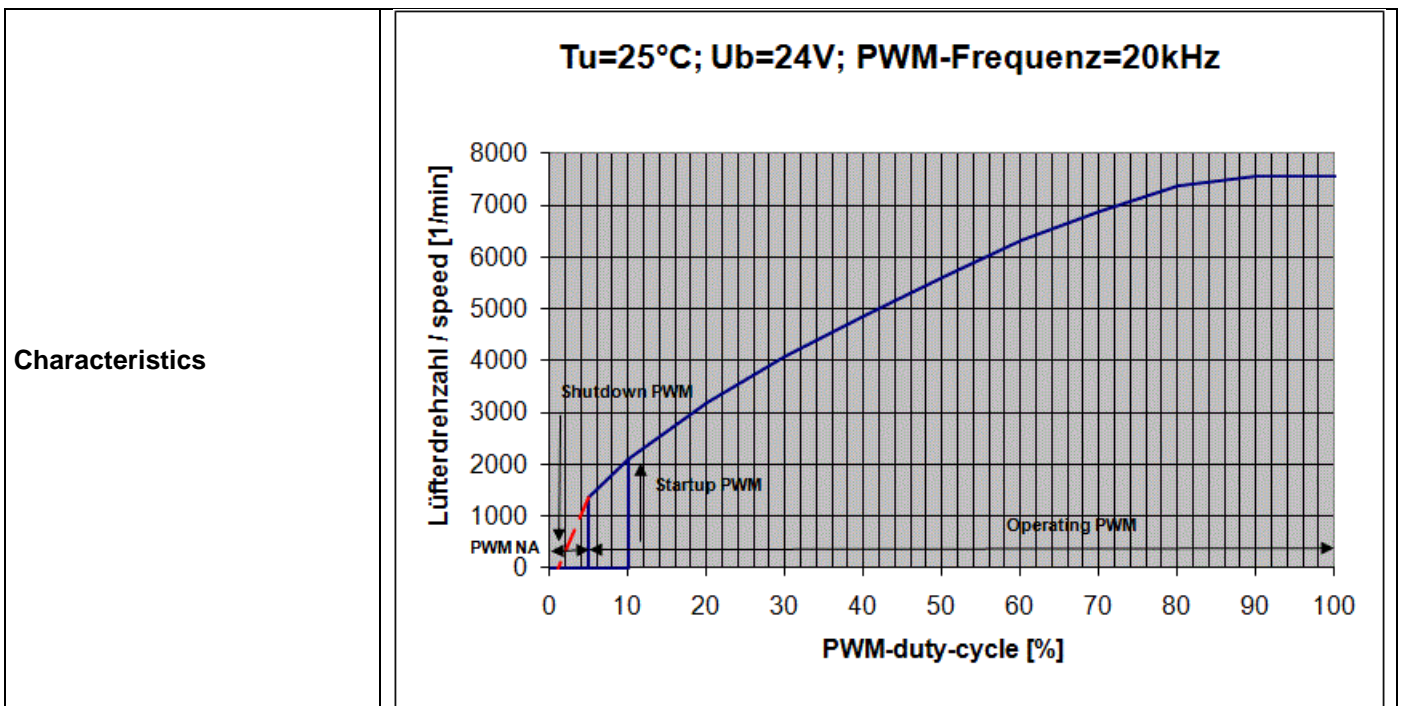

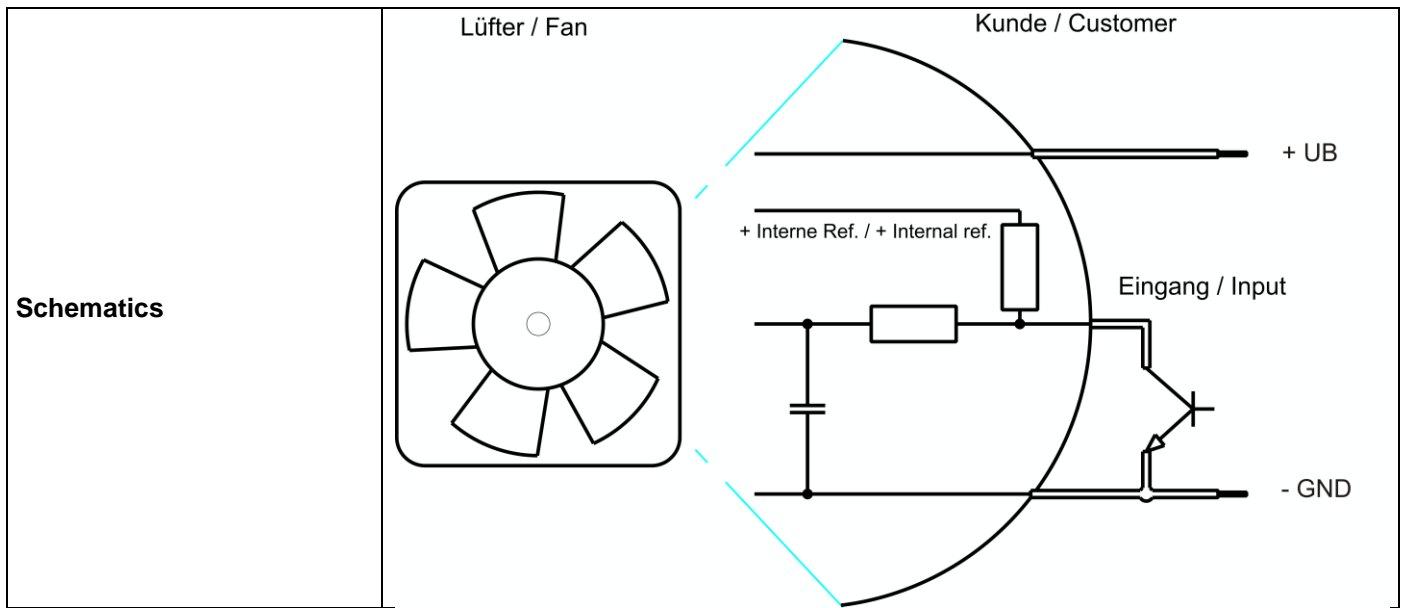

3.2 Electrical Operating Data

Measurement conditions: Normal air density = 1,2 kg/m³; Temperature 23°C +/- 3°C; Motor axis horizontal; warm-up time before measuring 5 minutes (unless otherwise specified). In the intake and outlet area should not be any solid obstruction within 0,5 m.

$\Delta p = 0$: corresp. to free air flow (see section 3.5)
 I: corresp. to arithm. mean current value

Name	Condition		
PWM 0001	PWM: 100 %; f: 25 kHz	f: 1 kHz	f: 30 kHz

Features	Condition	Symbol	Values		
Voltage range	$\Delta p = 0$	U	14,0 V		26,4 V
Nominal voltage	$\Delta p = 0$	U_N		24,0 V	
Power consumption	$\Delta p = 0$	P	12,6 W	35,0 W	41,0 W
Tolerance	PWM 0001		+/- 20 %	+/- 15 %	+/- 15 %
Current consumption	$\Delta p = 0$	I	900 mA	1.450 mA	1.550 mA
Tolerance	PWM 0001		+/- 20 %	+/- 15 %	+/- 20 %
Speed	$\Delta p = 0$	n	5.100 1/min	7.450 1/min	7.900 1/min
Tolerance	PWM 0001		+/- 15 %	+/- 10 %	+/- 15 %
Starting current consumption				<= 3.100 mA	

Name	Condition		
PWM 0002	PWM: 50 %; f: 25 kHz	f: 1 kHz	f: 30 kHz

Features	Condition	Symbol	Values		
Voltage range	$\Delta p = 0$	U	14,0 V		26,4 V
Nominal voltage	$\Delta p = 0$	U_N		24,0 V	
Power consumption	$\Delta p = 0$	P	5,5 W	17,0 W	20,0 W
Tolerance	PWM 0002		+/- 25 %	+/- 20 %	+/- 20 %
Current consumption	$\Delta p = 0$	I	390 mA	690 mA	770 mA
Tolerance	PWM 0002		+/- 25 %	+/- 20 %	+/- 25 %
Speed	$\Delta p = 0$	n	3.500 1/min	5.500 1/min	6.000 1/min
Tolerance	PWM 0002		+/- 20 %	+/- 15 %	+/- 20 %

3.3 Operating Data - Electrical Interface -Output

Tacho type	/2 (Open collector)
------------	---------------------

Signal-Ausgangsspannung / Signal output voltage

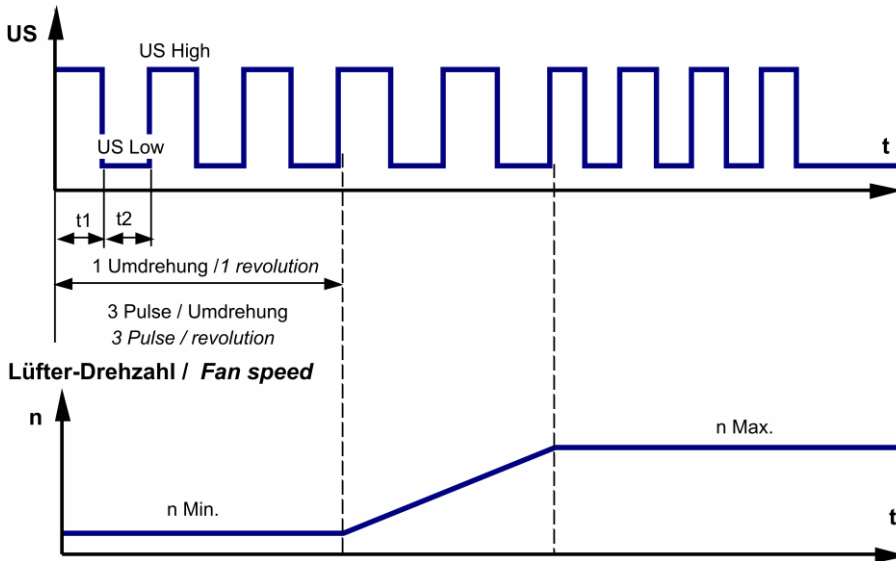

$$R_a = \frac{U_{BS} - U_{S\ Low}}{I_{Sink}}$$

Features	Note	Values
Tacho operating voltage (UBS)		$\leq 60 \text{ V}$
Tacho signal Low	I sink: 2 mA	$\leq 0,4 \text{ V}$
Tacho signal High	I source: 0 mA	60 V
Maximum sink current		$\leq 4 \text{ mA}$
External resistor	External resistor R_a from UBS to US required. All voltages measured to GND.	
Tacho frequency	$(3 \times n) / 60$	
Tacho isolated from motor	No	
Slew rate		$\Rightarrow 0,5 \text{ V/us}$

Alarm type	None
------------	------

3.4 Electrical Features

Electronic function	Speed-Controlled	
Reversed polarity protection	Rectifying diode	
Max. residual current at U_n	$I_F \leq 200 \text{ uA}$	
Locked rotor protection	Auto restart	
Locked rotor current at U_n	approx. 3.600 mA	
Clock signal t_3/t_4 at locked rotor	Typical: 1 s / 9 s t_3 : 0,7 s... 1,3 s t_4 : 6,5 s... 11,5 s	

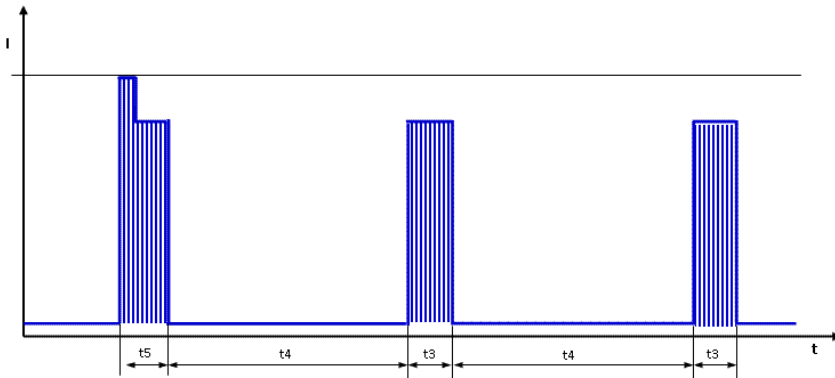

First pulse t_5 typical 1,6s (1,3 .. 1,9s) followed by t_4 . Afterwards cyclical t_3/t_4 .

3.5 Aerodynamic

Measurement conditions: Measured with a double chamber intake rig acc. to DIN EN ISO 5801.
 Normal air density = 1,2 kg/m³; Temperature 23°C +/- 3°C;
 In the intake and outlet area should not be any solid obstruction within 0,5 m.
 The information is only valid under the specified test conditions and may be changed by the installation conditions. If there are deviations from the standard test conditions, the characteristic values must be checked under the installed conditions.

a.) Operation condition:

7.450 1/min at free air flow	PWM 100 %; f: 25 kHz	f: 1 kHz	f: 30 kHz
------------------------------	----------------------	----------	-----------

Max. free-air flow ($\Delta p = 0 / \dot{V} = \text{max.}$)	270 m ³ /h	
Max. static pressure ($\Delta p = \text{max.} / \dot{V} = 0$)	370 Pa	

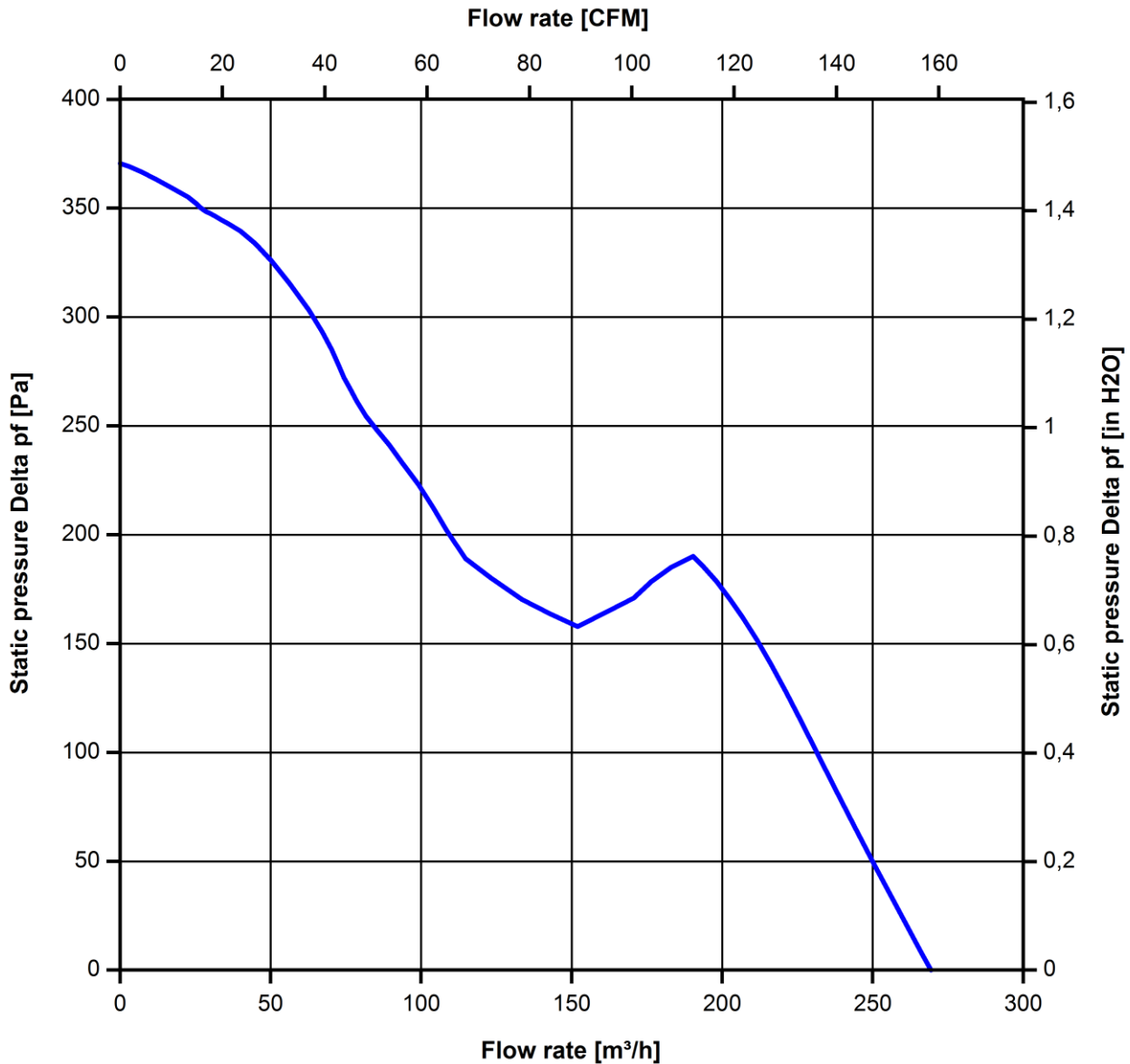

3.6 Sound Data

Measurement conditions: Sound pressure level: 1 Meter distance between microphone and the air intake.
 Sound power level: Acc. to DIN 45635 part 38 (ISO 10302)
 Measured in a semianchoic chamber with a background noise level of $L_p(A) < 5 \text{ dB(A)}$
 For further measurement conditions see section 3.5

a.) Operation condition:

7.450 1/min at free air flow	PWM 100 %; f: 25 kHz	PWM min.: ; f: 1 kHz	PWM max.:; f: 30 kHz
------------------------------	----------------------	----------------------	----------------------

Optimal operating point	191 m ³ /h @ 176 Pa	
Sound power level at the optimal operating point	7,6 bel(A)	
Sound pressure level at free air flow, measured in rubber bands	64,0 dB(A)	

4 Environment

4.1 General

Min. permitted ambient temperature TU min.	-20 °C	
Max. permitted ambient temperature TU max.	70 °C	
Min. permitted storage temperature TL min.	-40 °C	
Max. permitted storage temperature TL max.	85 °C	

4.2 Climatic requirements*)

Humidity requirements	humid heat, constant; according to DIN EN 60068-2-78, 14 days	
Water exposure	None	
Dust requirements	None	
Salt fog requirements	None	

*) Permitted application area:

The product is intended for use in sheltered rooms with controlled temperature and controlled humidity. Directly exposure to water must be avoided.

Pollution degree 1 (according DIN EN 60664-1)

There is either no pollution or it occurs only dry, non-conductive pollution. The pollution has no negative impact.

4.3 Mechanical requirements

severity level	stationary use		
1	storage / transportation	Random vibration not in use IEC 60068-2-64 Frequency range / ASD G_{RMS} Axes of vibration Test duration	Random vibration 5 - 20 Hz : $1,0 \text{ m}^2 / \text{s}^3$ 20 - 500 Hz : - 3 dB / Oct 0,91 G 3 3 x 30 min
	storage / transportation	Bump not in use IEC 60068-2-29 Shock spectrum Acceleration Duration Number of bumps (+X, -X, -Y, +Y, -Z, +Z) Total bumps	Bump half sine 18 G 6 ms 100 in each direction 600
	stationary use	Random vibration in use IEC 60068-2-64 Frequency range / ASD G_{RMS} Axes of vibration Test duration	Random vibration 5 - 10 Hz : +6 dB / Oct 10 - 50 Hz : $1,0 \text{ m}^2 / \text{s}^3$ 50 - 200 Hz : - 6 dB / Oct 0,65 G 3 3 x 30 min
	stationary use	Bump in use IEC 60068-2-29 Shock spectrum Acceleration Duration Number of bumps (+X, -X, -Y, +Y, -Z, +Z) Total bumps	Bump half sine 5 G 11 ms 100 in each direction 600

5 Safety

5.1 Electrical Safety

Dielectric strength DIN EN 60950 (VDE 0805) and DIN EN 60335 (VDE 0700) A.) Type test Measuring conditions: After 48h of storage at 95% R.H. and 25°C. No arcing or breakdown is allowed! All connections together to ground.	500 VAC / 1 Min.	
B.) Routine test Measuring conditions: At indoor climate. No arcing or breakdown is allowed! All connections together to ground.	500 VAC / 1 Sec.	
Isolation resistance Measuring conditions: After 48h of storage at 95% R.H. and 25°C measured with U=500 VDC for 1 min.	RI > 10 MOhm	
clearance / creepage distance	1,0 mm / 1,2 mm	
Protection class	III	

5.2 Approval Tests

CE	Yes
UL	Yes / UL507, Electric Fans
VDE	Yes / Approval acc. to EN 60950 (VDE 0805) - Information technology equipment
CSA	Yes / C22.2 No. 113 Fans and Ventilators
CCC	No

6 Reliability

6.1 General

Life expectancy L10 at TU = 40 °C	85.000 h	
Life expectancy L10 at TU max.	42.500 h	

Copying of this document, and printing, and storing, is either not the use or reproduction of the contents thereof, or a
 violation of the copyright law, or a violation of the patent law, or a violation of the trademark law, or a violation of the
 law in the event of the patent, or a violation of the trademark law, or a violation of the copyright law.



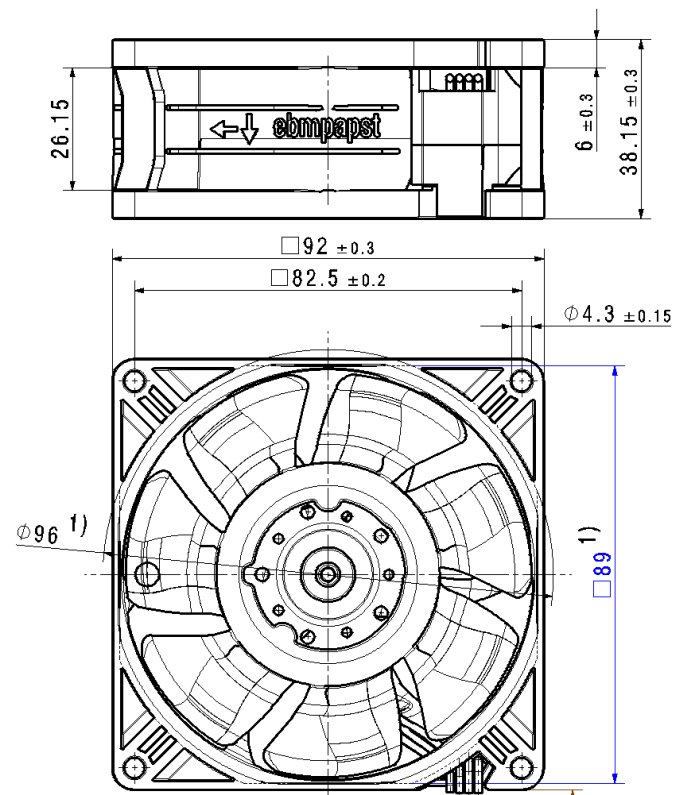





Schutzrecht nach DIN 130 1810 Rechte /
 Mark to protection under DIN 130 1810

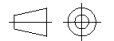

1) Maße für Montagewand
 1) dimension for worktop mounting

-Anzahl und Länge der Litzen siehe Produktspezifikation
 number and length of the wires, look at the product specification

-Kein Axialspiel bei Kugellager durch Federausgleich
 no axial clearance of ball bearings conditional on a pre-load spring

SAP-Status/State		Änd.-Nr./ Change-No.		CATIA-System-Version/ CATIA-System-Version		CAD-Umgebung/ CAD-Environment		Werkstoff / Material:		Volumen / Volume (cm³):	
											
Tolerierung / Tolerances:		Datum		Name		3D-Referenzmodell / 3D-Referenzmodell		Artikel / Title:		Gewicht / Mass (g):	
Allgemeintoleranzen / Gen. Tolerances:		Bearb./ Drawn		Zug.-Nr. / Drawing No:		Erst-/Zug. / Replace:		Zug.-Nr. / Drawing No:		Erst-/Zug. / Replace:	
		Dopp./ Checked		Dokumenttyp / Type of Document		Teildokument / (Start/End)		Index / Index		Format / Size:	
		Freig./ Released		ebmpapst		ebmpapst		ebmpapst		ebmpapst	
