

3-MODES/ 3W WLED DRIVER WITH 1 OR 2 CELL BATTERY

Description

The PAM2805 is a step-up DC-DC WLED driver with 3 modes cycling function (100% brightness, 25% brightness and 8.5Hz blinking).

The unique 3 modes cycling function can eliminate the needs of extra functional MCU or IC.

The PAM2805 can deliver up to 750mA output current by setting an external resistor.

The PAM2805 switches at a 1.0MHz constant frequency, allowing for the use of small value external inductor and ceramic capacitors.

A low 95mV feedback voltage reduces the power loss in the R_S for better efficiency. With its internal 2A, 100mΩ device can provide high efficiency even at heavy load.

The PAM2805 is available in TSOT26 package.

Pin Assignments

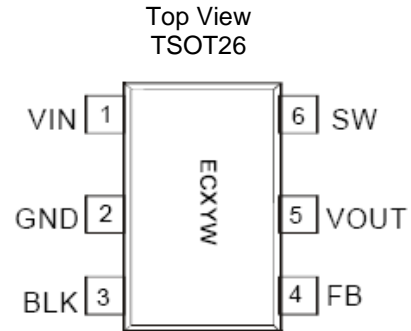

Applications

- White LED Torch (Flashlight)

Features

- 3 Modes Cycling Function:

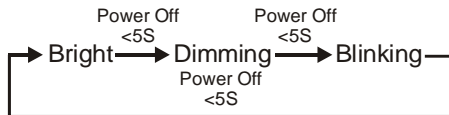

- Reset to Bright Mode if Power Off time More Than 5S
- Adjustable Output Current: Up to 750mA
- 8.5Hz Blinking Mode
- Low Start-Up Voltage: 0.9V(typ)
- Low SW on Resistance: 100mΩ
- Over Temperature Protection
- Over Voltage Protection
- TSOT26 Package
- Pb-Free Package

Typical Applications Circuit

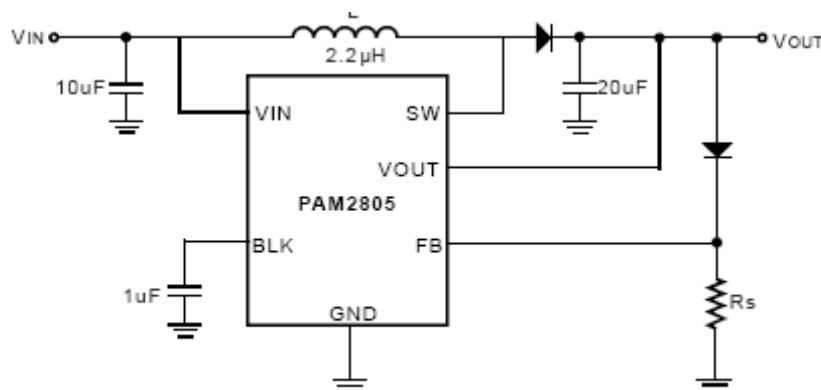

$I_{LED} + 95mV/R_S$

Pin Description

Pin Number	Pin Name	Function
1	VIN	Input Voltage
2	GND	Power Ground
3	BLK	Connect A 1 μ F CAP for blinking
4	FB	Feedback
5	VOUT	Output Voltage
6	SW	Connected to an internal NMOS switch

Block Diagram

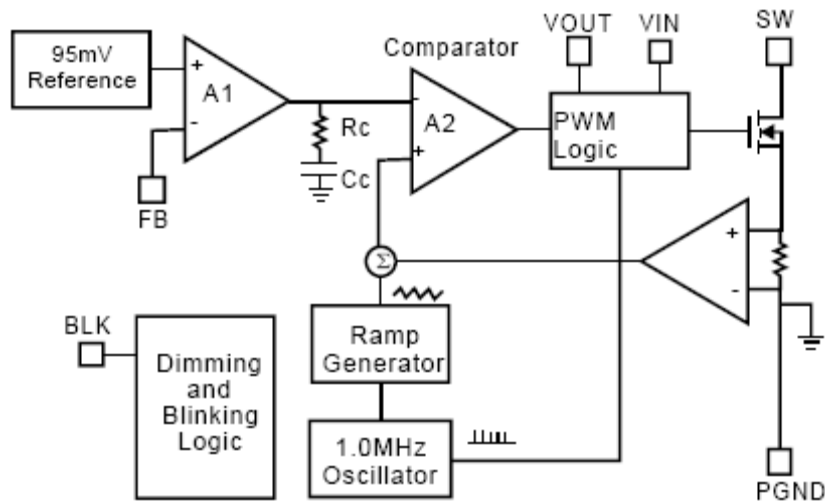

Absolute Maximum Ratings (@T_A = +25°C, unless otherwise specified.)

These are stress ratings only and functional operation is not implied. Exposure to absolute maximum ratings for prolonged time periods may affect device reliability. All voltages are with respect to ground.

Parameter	Rating	Unit
Supply Voltage	6	V
Output Voltage	6	
Storage Temperature Range	-65 to +150	°C
Lead Temperature (Soldering, 5 sec)	300	

Recommended Operating Conditions (@T_A = +25°C, unless otherwise specified.)

Parameter	Rating	Unit
Operation Temperature Range	-40 to +85	°C
Junction Temperature Range	-40 to +125	

Thermal Information

Parameter	Symbol	Package	Max	Unit
Thermal Resistance (Junction to Case)	θ_{JC}	TSOT26	130	°C/W
Thermal Resistance (Junction to Ambient)	θ_{JA}	TSOT26	250	
Internal Power Dissipation @ $T_A = 25^\circ\text{C}$	P_D	TSOT26	400	mW

Electrical Characteristics

(@ $T_A = +25^\circ\text{C}$, $L = 2.2\mu\text{H}$, $C_{IN} = 10\mu\text{F}$, $C_{OUT} = 10\mu\text{F}$, $C_{BLK} = 1\mu\text{F}$, $V_F = 3.4\text{V}$ unless otherwise specified.)

Parameter	Symbol	Test Conditions	Min	Typ	Max	Units
Input Voltage Range	V_{IN}		0.9		$V_F - 0.2$ (Note 1)	V
Feedback Voltage	V_{FB}		90	95	100	mV
Start-Up Voltage	V_{START}	$V_{IN}: 0\text{V} \rightarrow 3\text{V}$, $I_{LED} = 200\text{mA}$		0.9		V
Hold Voltage	V_{HOLD}	$V_{IN}: 3\text{V} \rightarrow 0\text{V}$, $I_{LED}: 750\text{mA} \rightarrow 100\text{mA}$		0.7		V
Oscillator Frequency	f_{OSC}		0.85	1.0	1.15	MHz
Over Temperature Shutdown	OTS			150		°C
Over Temperature Hysteresis	OTH			30		°C
Maximum Output Current Range	$I_{O(MAX)}$	$V_{IN} = 2.4\text{V}$	750			mA
Quiescent Current	I_Q	$I_{LED} = 0\text{mA}$, $V_O = 3.4\text{V}$, Device Switching at 1MHz		1	3	mA
Switch On Resistance	$R_{DS(ON)}$	$V_O = 3.4\text{V}$		0.1		Ω
Current Limit	I_{LIM}	$V_O = 3.4\text{V}$	2			A
Over Voltage Protection (VOUT)	V_{OVP}			4.5		V
Blinking Frequency	F_{BLK}	$C_{BLK} = 1\mu\text{F}$		8.5	10	Hz

Note: 1. V_F ---LED forward voltage

Typical Performance Characteristics

(@T_A = +25°C, L = 2.2μF, C_{IN} = 10μF, C_{OUT} = 10μF, C_{BLK} = 1μF, unless otherwise specified.)

1. LED Power Efficiency vs Input Voltage

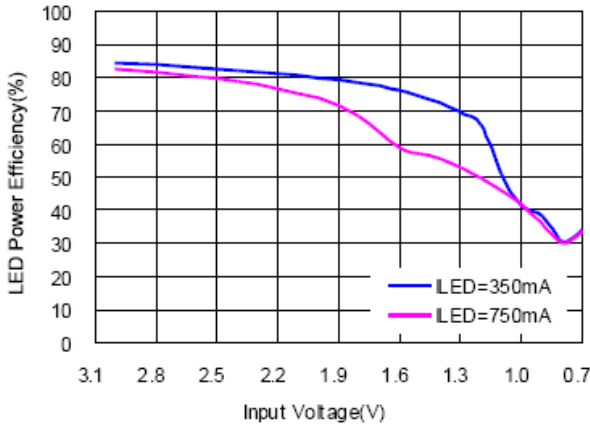

2. LED Current vs Input Voltage

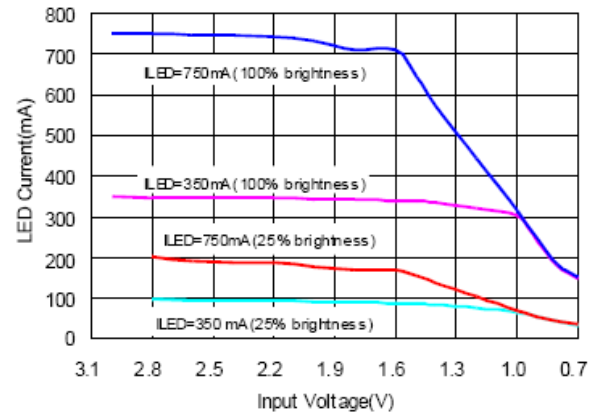

3. DC Input Current vs Input Voltage

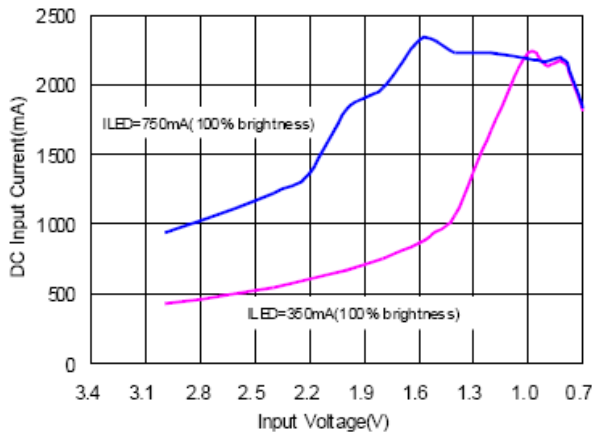

4. Feedback Voltage vs Input Voltage

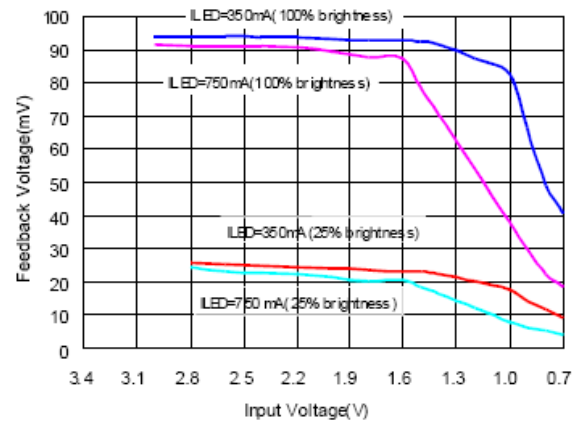

Typical Performance Characteristics (cont.)

(@T_A = +25°C, L = 2.2µF, C_{IN} = 10µF, C_{OUT} = 10µF, C_{BLK} = 1µF, unless otherwise specified.)

5. 3 Modes Change

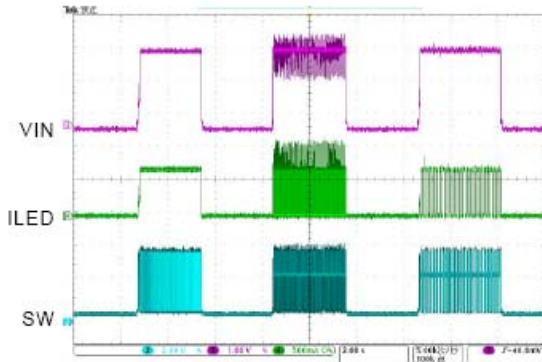

6. Start-Up Waveform

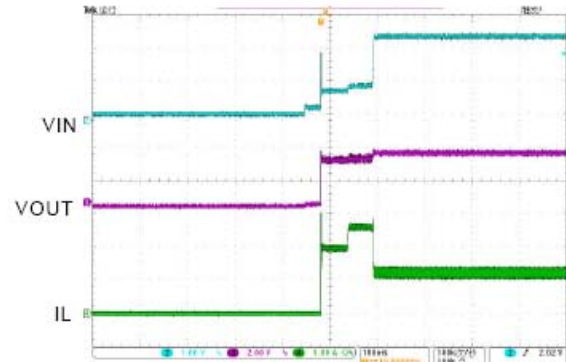

7. Overvoltage Protection

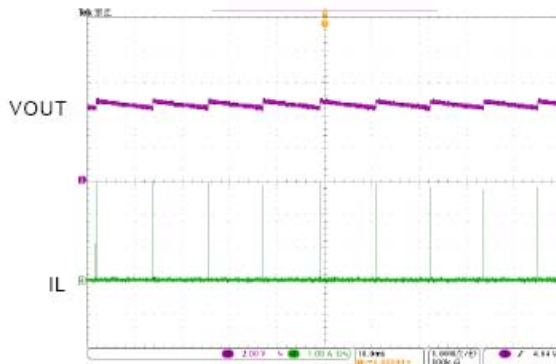

8. Switching Waveform

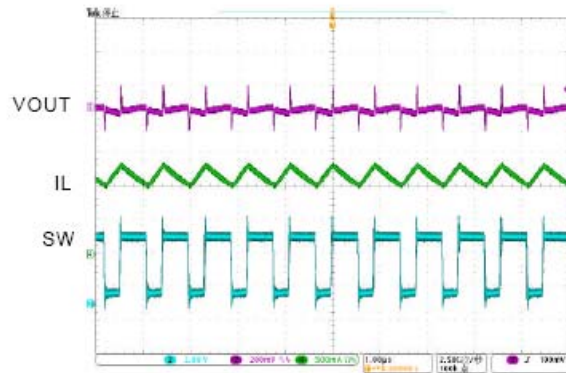

Application Information

Inductor Selection

The PAM2805 can use small value inductors due to its switching frequency of 1 MHz. The value of inductor will focus in the range of 2.2 μ H to 4.7 μ H for most PAM2805 applications. In typical high current white LED applications, it is recommended to use a 4.7 μ H inductor. The inductor should have low DCR (DC resistance) to minimize the I^2R power loss, and it requires a current rating of 2A to handle the peak inductor current without saturating.

Capacitor Selection

An input capacitor is required to reduce the input ripple and noise for proper operation of the PAM2805. For good input decoupling, Low ESR (equivalent series resistance) capacitors should be used at the input. At least 2.2 μ F input capacitor is recommended for most applications.

A minimum output capacitor value of 6.8 μ F is recommended under normal operating conditions, while a 10 μ F-22 μ F capacitor may be required for higher power LED current. A reasonable value of the output capacitor depends on the LED current. The ESR of the output capacitor is the important parameter to determine the output voltage ripple of the converter, so low ESR capacitors should be used at the output to reduce the output voltage ripple. The small size of ceramic capacitors is an excellent choice for PAM2805 applications. The X5R and X7R types are preferred because they maintain capacitance over wide voltage and temperature ranges.

Diode Selection

It's indispensable to use a Schottky diode rated at 2A with the PAM2805. Using a Schottky diode with a lower forward voltage drop is better to improve the power LED efficiency, and its voltage rating should be greater than the output voltage. SS22 is recommended Schottky diode for rectifier.

LED Current Setting

The LED current is set by the single external R_S resistor connected to the FB pin as shown in the typical application circuit on Page 1. The typical FB reference is internally regulated to 95mV. The LED current is $95\text{mV}/R_1$. It's recommended to use a 1% or better precision resistor for the better LED current accuracy. The formula for R_S selection is shown as follows:

$$R_S (\Omega) = 95\text{mV} / I_{\text{LED}} (\text{mA}) \text{ at } V_{\text{IN}} = 3\text{V}$$

Typically, for 1W(330mA) and 3W(750mA) LED light applications, the R_S are 0.288 Ω and 0.127 Ω respectively.

3 Modes Cycling

The PAM2805 has three modes: 100% brightness, 25% brightness and blinking (typical 8.5Hz).

The mode change is triggered by power on/off actions and cycles in the following sequence: bright, dimming, blinking and back to bright mode.

The PAM2805 will reset to the bright mode after being power off for more than 5 seconds.

Low Voltage Start-Up and Soft-Start

The PAM2805 has a build-in low voltage startup circuit for the best battery life solution. It can start up at 0.9V V_{IN} typically when the preset LED current is 200mA.

The soft-start function is made by clamping the output voltage of error amplifier with another voltage source which increases slowly from zero to near V_{IN} during the soft-start period. Therefore, the duty cycle of the PWM will be increased from zero to maximum in this period. The charging time of the inductor will be limited by the smaller duty so that the inrush current can be reduced to an acceptable value.

Over Voltage Protection

The output voltage of PAM2805 is monitored by Over Voltage Protection circuit. Once V_{OUT} goes over V_{OVP} , typically 4.5V, the power NMOS is turned off and SW pin stops switching. Then, the V_{OUT} is clamped to around V_{OVP} .

Over Current Protection

The inductor current during charging period is detected by a current sensing circuit. When the value is larger than current limiting I_{LIM} , the power NMOS is turned off so that the inductor will be forced to leave charging stage and enter discharging stage. Therefore, the inductor peak current will not exceed I_{LIM} , whose minimum value is 2A.

Application Information

PCB Layout Guidelines

As for all switching power supplies, the layout and components placement of the PAM2805 is an important step in the design; especially at high peak currents and high switching frequencies.

The input capacitor and output capacitor should be placed respectively as close as possible to the input pin and output pin of the IC; the inductor and schottky diode should be placed as close as possible to the switch pin by using wide and short traces for the main current path; the current sense resistor should be placed as close as possible between the ground pin and feedback pin.

Ordering Information

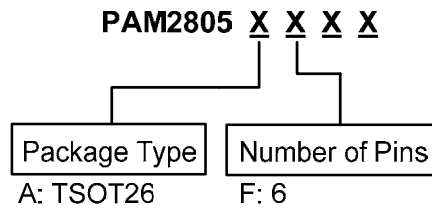

Part Number	Marking	Package Type	Standard Package
PAM2805AF	ECXYW	TSOT26	3000 Units/Tape&Reel

Marking Information

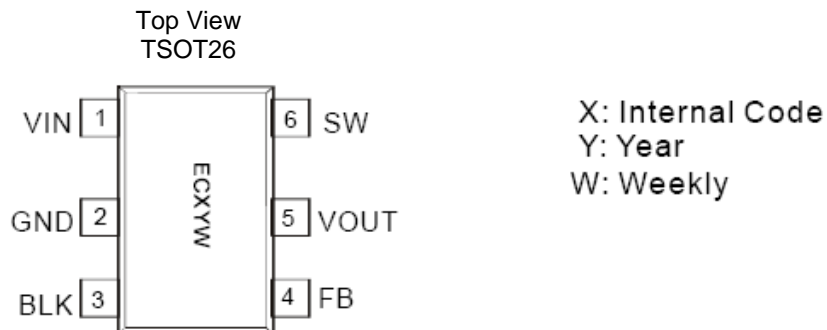

Package Outline Dimensions (All dimensions in mm.)

TSOT26

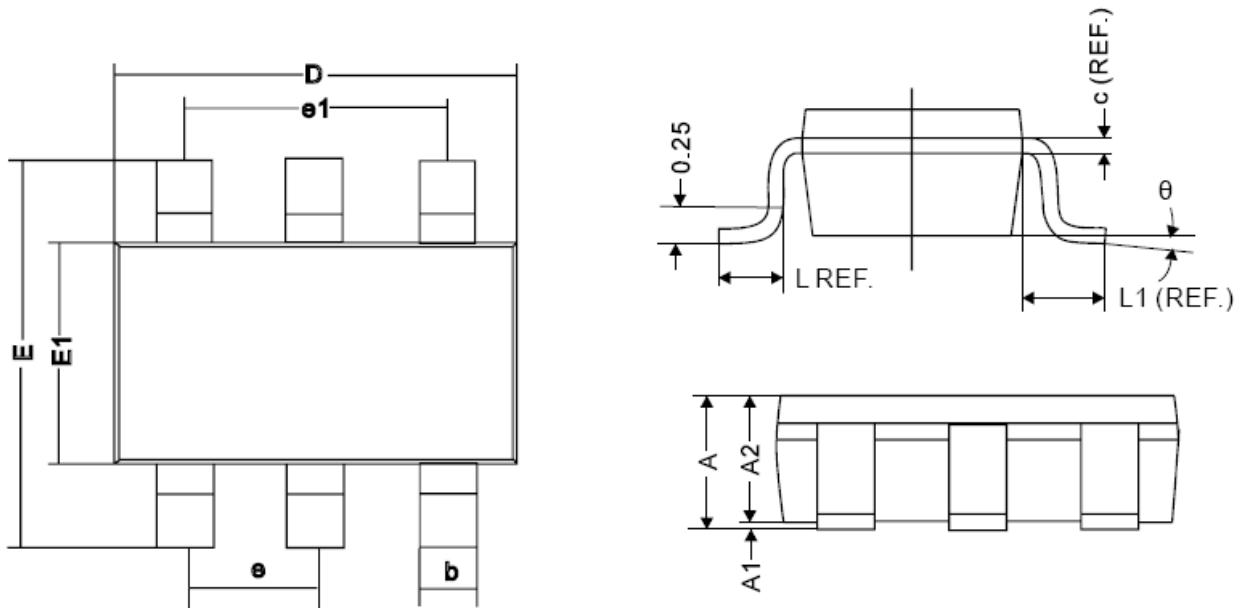

REF.	Millimeter	
	Min	Max
A	-	1.35
A1	0.04	0.15
A2	0.70	1.2
c	0.12REF.	
D	2.70	3.10
E	2.60	3.00
E1	1.40	1.80
L	0.45REF.	
L1	0.60REF.	
θ	0°	10°
b	0.30	0.50
e	0.95REF.	
e1	1.90REF.	

IMPORTANT NOTICE

DIODES INCORPORATED MAKES NO WARRANTY OF ANY KIND, EXPRESS OR IMPLIED, WITH REGARDS TO THIS DOCUMENT, INCLUDING, BUT NOT LIMITED TO, THE IMPLIED WARRANTIES OF MERCHANTABILITY AND FITNESS FOR A PARTICULAR PURPOSE (AND THEIR EQUIVALENTS UNDER THE LAWS OF ANY JURISDICTION).

Diodes Incorporated and its subsidiaries reserve the right to make modifications, enhancements, improvements, corrections or other changes without further notice to this document and any product described herein. Diodes Incorporated does not assume any liability arising out of the application or use of this document or any product described herein; neither does Diodes Incorporated convey any license under its patent or trademark rights, nor the rights of others. Any Customer or user of this document or products described herein in such applications shall assume all risks of such use and will agree to hold Diodes Incorporated and all the companies whose products are represented on Diodes Incorporated website, harmless against all damages.

Diodes Incorporated does not warrant or accept any liability whatsoever in respect of any products purchased through unauthorized sales channel.

Should Customers purchase or use Diodes Incorporated products for any unintended or unauthorized application, Customers shall indemnify and hold Diodes Incorporated and its representatives harmless against all claims, damages, expenses, and attorney fees arising out of, directly or indirectly, any claim of personal injury or death associated with such unintended or unauthorized application.

Products described herein may be covered by one or more United States, international or foreign patents pending. Product names and markings noted herein may also be covered by one or more United States, international or foreign trademarks.

This document is written in English but may be translated into multiple languages for reference. Only the English version of this document is the final and determinative format released by Diodes Incorporated.

LIFE SUPPORT

Diodes Incorporated products are specifically not authorized for use as critical components in life support devices or systems without the express written approval of the Chief Executive Officer of Diodes Incorporated. As used herein:

A. Life support devices or systems are devices or systems which:

1. are intended to implant into the body, or
2. support or sustain life and whose failure to perform when properly used in accordance with instructions for use provided in the labeling can be reasonably expected to result in significant injury to the user.

B. A critical component is any component in a life support device or system whose failure to perform can be reasonably expected to cause the failure of the life support device or to affect its safety or effectiveness.

Customers represent that they have all necessary expertise in the safety and regulatory ramifications of their life support devices or systems, and acknowledge and agree that they are solely responsible for all legal, regulatory and safety-related requirements concerning their products and any use of Diodes Incorporated products in such safety-critical, life support devices or systems, notwithstanding any devices- or systems-related information or support that may be provided by Diodes Incorporated. Further, Customers must fully indemnify Diodes Incorporated and its representatives against any damages arising out of the use of Diodes Incorporated products in such safety-critical, life support devices or systems.

Copyright © 2013, Diodes Incorporated

www.diodes.com