

### Features

- Epitaxial Planar Die Construction
- Complementary NPN Type Available (MMST3904)
- Ultra-Small Surface Mount Package
- Also Available in Lead Free Version

### Mechanical Data

- Case: SOT-323, Molded Plastic
- Case Material - UL Flammability Rating 94V-0
- Moisture sensitivity: Level 1 per J-STD-020A
- Terminals: Solderable per MIL-STD-202, Method 208
- Also Available in Lead Free Plating (Matte Tin Finish). Please see Ordering Information, Note 4, on Page 2
- Terminal Connections: See Diagram
- Marking (See Page 2): K5N
- Weight: 0.006 grams (approx.)
- Ordering & Date Code Information: See Page 2

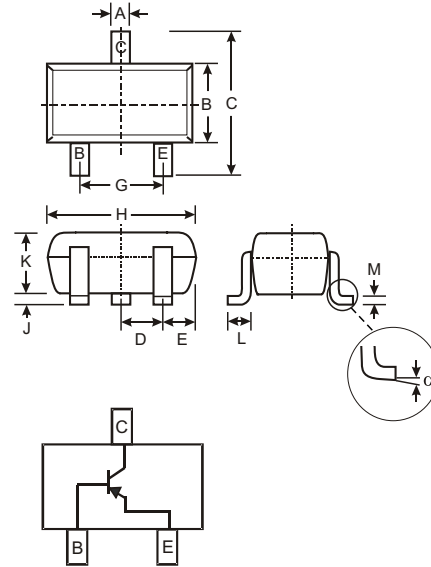

SOT-323		
Dim	Min	Max
A	0.25	0.40
B	1.15	1.35
C	2.00	2.20
D	0.65 Nominal	
E	0.30	0.40
G	1.20	1.40
H	1.80	2.20
J	0.0	0.10
K	0.90	1.00
L	0.25	0.40
M	0.10	0.18
$\alpha$	0°	8°
All Dimensions in mm		

### Maximum Ratings @ $T_A = 25^\circ\text{C}$ unless otherwise specified

Characteristic	Symbol	MMST3906	Unit
Collector-Base Voltage	$V_{CBO}$	-40	V
Collector-Emitter Voltage	$V_{CEO}$	-40	V
Emitter-Base Voltage	$V_{EBO}$	-5.0	V
Collector Current - Continuous (Note 1)	$I_C$	-200	mA
Power Dissipation (Note 1)	$P_d$	200	mW
Thermal Resistance, Junction to Ambient (Note 1)	$R_{\theta JA}$	625	K/W
Operating and Storage and Temperature Range	$T_j, T_{STG}$	-55 to +150	$^\circ\text{C}$

Note: 1. Device mounted on FR-4 PCB, 1 inch x 0.85 inch x 0.062 inch; pad layout as shown on Diodes Inc. suggested pad layout document AP02001, which can be found on our website at <http://www.diodes.com/datasheets/ap02001.pdf>.

**Electrical Characteristics** @  $T_A = 25^\circ\text{C}$  unless otherwise specified

Characteristic	Symbol	Min	Max	Unit	Test Condition
<b>OFF CHARACTERISTICS (Note 2)</b>					
Collector-Base Breakdown Voltage	$V_{(BR)CBO}$	-40	—	V	$I_C = -10\mu\text{A}, I_E = 0$
Collector-Emitter Breakdown Voltage	$V_{(BR)CEO}$	-40	—	V	$I_C = -1.0\text{mA}, I_B = 0$
Emitter-Base Breakdown Voltage	$V_{(BR)EBO}$	-5.0	—	V	$I_E = -10\mu\text{A}, I_C = 0$
Collector Cutoff Current	$I_{CEX}$	—	-50	nA	$V_{CE} = -30\text{V}, V_{EB(OFF)} = -3.0\text{V}$
Base Cutoff Current	$I_{BL}$	—	-50	nA	$V_{CE} = -30\text{V}, V_{EB(OFF)} = -3.0\text{V}$
<b>ON CHARACTERISTICS (Note 2)</b>					
DC Current Gain	$h_{FE}$	60 80 100 60 30	— — 300 — —	—	$I_C = -100\mu\text{A}, V_{CE} = -1.0\text{V}$ $I_C = -1.0\text{mA}, V_{CE} = -1.0\text{V}$ $I_C = -10\text{mA}, V_{CE} = -1.0\text{V}$ $I_C = -50\text{mA}, V_{CE} = -1.0\text{V}$ $I_C = -100\text{mA}, V_{CE} = -1.0\text{V}$
Collector-Emitter Saturation Voltage	$V_{CE(SAT)}$	—	-0.20 -0.30	V	$I_C = -10\text{mA}, I_B = -1.0\text{mA}$ $I_C = -50\text{mA}, I_B = -5.0\text{mA}$
Base-Emitter Saturation Voltage	$V_{BE(SAT)}$	-0.65 —	-0.85 -0.95	V	$I_C = -10\text{mA}, I_B = -1.0\text{mA}$ $I_C = -50\text{mA}, I_B = -5.0\text{mA}$
<b>SMALL SIGNAL CHARACTERISTICS</b>					
Output Capacitance	$C_{obo}$	—	4.5	pF	$V_{CB} = -5.0\text{V}, f = 1.0\text{MHz}, I_E = 0$
Input Capacitance	$C_{ibo}$	—	10	pF	$V_{EB} = -0.5\text{V}, f = 1.0\text{MHz}, I_C = 0$
Input Impedance	$h_{ie}$	2.0	12	k $\Omega$	$V_{CE} = 1.0\text{V}, I_C = 10\text{mA}, f = 1.0\text{kHz}$
Voltage Feedback Ratio	$h_{re}$	0.1	10	$\times 10^{-4}$	
Small Signal Current Gain	$h_{fe}$	100	400	—	
Output Admittance	$h_{oe}$	3.0	60	$\mu\text{S}$	
Current Gain-Bandwidth Product	$f_T$	300	—	MHz	$V_{CE} = -20\text{V}, I_C = -10\text{mA}, f = 100\text{MHz}$
Noise Figure	NF	—	4.0	dB	$V_{CE} = -5.0\text{V}, I_C = -100\mu\text{A}, R_S = 1.0\text{k}\Omega, f = 1.0\text{kHz}$
<b>SWITCHING CHARACTERISTICS</b>					
Delay Time	$t_d$	—	35	ns	$V_{CC} = -3.0\text{V}, I_C = -10\text{mA}, V_{BE(off)} = 0.5\text{V}, I_{B1} = -1.0\text{mA}$
Rise Time	$t_r$	—	35	ns	
Storage Time	$t_s$	—	225	ns	$V_{CC} = -3.0\text{V}, I_C = -10\text{mA}, I_{B1} = I_{B2} = -1.0\text{mA}$
Fall Time	$t_f$	—	75	ns	

**Ordering Information** (Note 3)

Device	Packaging	Shipping
MMST3906-7	SOT-323	3000/Tape & Reel

- Notes:
- Short duration test pulse used to minimize self-heating effect.
  - For Packaging Details, go to our website at <http://www.diodes.com/datasheets/ap02007.pdf>.
  - For Lead Free version (with Lead Free terminal finish) part number, please add "-F" suffix to part number above.  
Example: MMST3906-7-F.

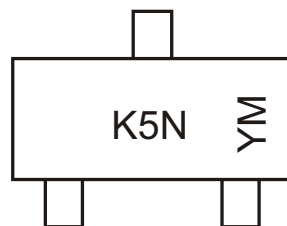
**Marking Information**

K5N = Product Type Marking Code  
 YM = Date Code Marking  
 Y = Year ex: N = 2002  
 M = Month ex: 9 = September

## Date Code Key

Year	1998	1999	2000	2001	2002	2003	2004	2005	2006	2007	2008	2009
Code	J	K	L	M	N	P	R	S	T	U	V	W

Month	Jan	Feb	March	Apr	May	Jun	Jul	Aug	Sep	Oct	Nov	Dec
Code	1	2	3	4	5	6	7	8	9	O	N	D

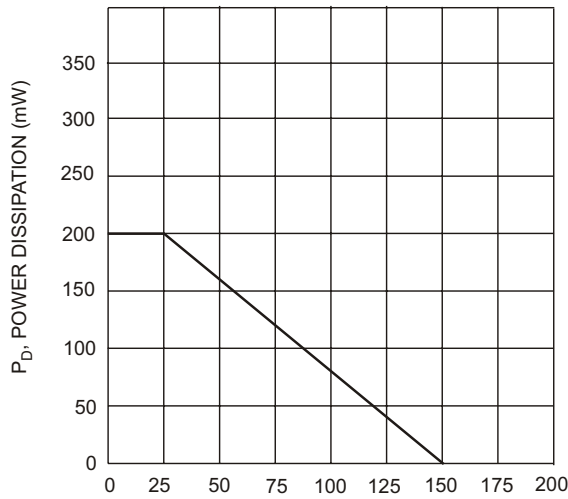

$T_A$ , AMBIENT TEMPERATURE ( $^{\circ}$ C)  
Fig. 1, Max Power Dissipation vs Ambient Temperature

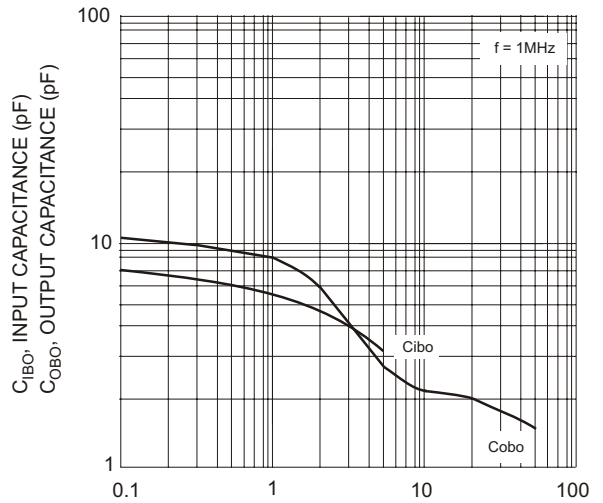

$V_{CB}$ , COLLECTOR-BASE VOLTAGE (V)  
Fig. 2, Input and Output Capacitance vs. Collector-Base Voltage

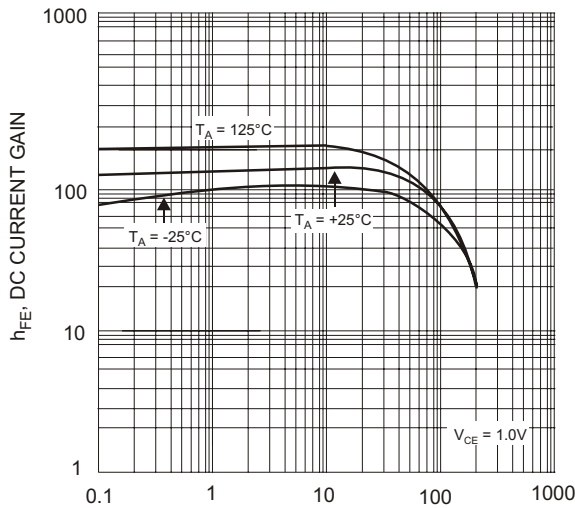

$I_C$ , COLLECTOR CURRENT (mA)  
Fig. 3, Typical DC Current Gain vs Collector Current

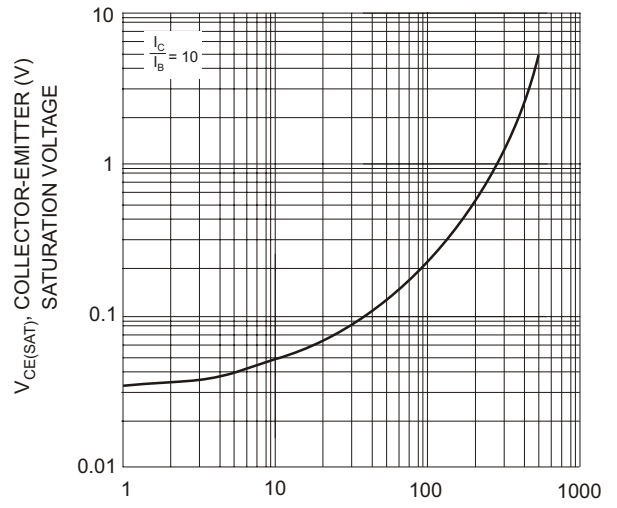

$I_C$ , COLLECTOR CURRENT (mA)  
Fig. 4, Typical Collector-Emitter Saturation Voltage vs. Collector Current

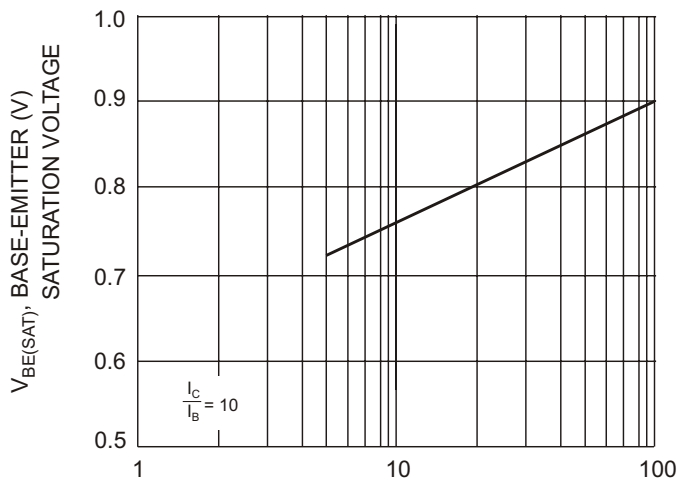

$I_C$ , COLLECTOR CURRENT (mA)  
Fig. 5, Typical Base-Emitter Saturation Voltage vs. Collector Current