

Product Summary

V _{RRM} (V)	I _O (A)	V _F TYP (V) @ +25°C	t _{RR} max (ns) @ +25°C	I _{RM} TYP (A) @ +25°C
600	8	1.95	20	3.9

Description and Application

The DSR8F600 Hyperfast Rectifier has been designed specifically for use as a boost diode in Power Factor Correction (PFC) applications. Its soft very fast switching characteristics make it ideal for use in hard switching and Continuous Conduction Mode (CCM) PFC circuits. It can be used in

- High Output SMPS
- Servers and Telecom Equipment
- Flat-panel TVs

Features and Benefits

- Low V_F Minimizes Boost Diode Conduction Losses
- Very Fast t_{RR} Reduces MOSFET PFC Switching Losses
- Soft Switching Ensures Ringing and EMI are Reduced
- Low Q_{RR} and I_{RM} Minimize Boost Diode Recovery Losses
- **Lead-Free Finish; RoHS Compliant (Notes 1 & 2)**
- **Halogen and Antimony Free. "Green" Device (Note 3)**

Mechanical Data

- Case: TO220AC
- Case Material: Molded Plastic, UL Flammability Classification Rating 94V-0
- Terminals: Matte Tin Finish Annealed over Copper Leadframe. Solderable per MIL-STD-202, Method 208 Ⓔ
- Moisture Sensitivity: Level 1 per J-STD-020
- Terminal Connections: See Diagram Below
- Weight: 1.75 grams (Approximate)

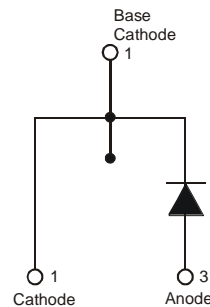

Package Pin Out Configuration

Ordering Information (Note 4)

Part Number	Case	Packaging
DSR8F600	TO220AC	50 pieces/tube

- Notes:
1. EU Directive 2002/95/EC (RoHS) & 2011/65/EU (RoHS 2) compliant. All applicable RoHS exemptions applied.
 2. See http://www.diodes.com/quality/lead_free.html for more information about Diodes Incorporated's definitions of Halogen- and Antimony-free, "Green" and Lead-free.
 3. Halogen- and Antimony-free "Green" products are defined as those which contain <900ppm bromine, <900ppm chlorine (<1500ppm total Br + Cl) and <1000ppm antimony compounds.
 4. For packaging details, go to our website at <http://www.diodes.com/products/packages.html>.

Marking Information

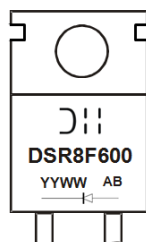

DSR8F600 = Product Type Marking Code
 AB = Foundry and Assembly Code
 YYWW = Date Code Marking
 YY = Last Two Digits of Year (ex: 15 = 2015)
 WW = Week (01 to 53)

Maximum Ratings (@T_A = +25°C, unless otherwise specified.)

Single phase, half wave, 60Hz, resistive or inductive load.

Characteristic	Symbol	Value	Unit
Peak Repetitive Reverse Voltage	V _{RRM}	600	V
Working Peak Reverse Voltage	V _{RWM}		
DC Blocking Voltage	V _{RM}		
Average Rectified Output Current	I _O	8	A
Non-Repetitive Peak Forward Surge Current 8.3ms Single Half Sine-Wave Superimposed on Rated Load	I _{FSM}	75	A

Thermal Characteristics

Characteristic	Symbol	Value	Unit
Typical Thermal Resistance, Junction to Case (Note 5)	R _{θJC}	3.4	°C/W
Typical Thermal Resistance, Junction to Ambient (Note 5)	R _{θJA}	46	°C/W
Typical Thermal Resistance, Junction to Case (Note 6)	R _{θJC}	1.6	°C/W
Typical Thermal Resistance, Junction to Ambient (Note 6)	R _{θJA}	7	°C/W
Storage Temperature Range	T _{STG}	-55 to +150	°C
Maximum Operating Junction Temperature	T _J	+150	°C

Electrical Characteristics (@T_A = +25°C, unless otherwise specified.)

Characteristic	Symbol	Min	Typ	Max	Unit	Test Condition
Forward Voltage Drop	V _F	—	1.8	—	V	I _F = 5A, T _J = +25°C
		—	1.95	2.7		I _F = 8A, T _J = +25°C
		—	1.6	—		I _F = 8A, T _J = +125°C
Leakage Current (Note 7)	I _R	—	9	80	μA	V _R = 600V, T _J = +25°C
		—	500	1500		V _R = 500V, T _J = +100°C
Reverse Recovery Time	t _{RR}	—	14.6	20	ns	I _F = 0.5A, I _R = 1.0A, I _{RR} = 0.25A
Reverse Recovery Time	t _{RR}	—	35	45	ns	I _F = 8A, dI/dt = 300A/μs,
Reverse Recovery Charges	Q _{RR}	—	85	—	nC	V _R = 400V, T _J = +25°C
Reverse Recovery Current	I _{RM}	—	5.9	—	A	I _F = 8A, dI/dt = 300A/μs, V _R = 400V, T _J = +125°C
Junction Capacitance	C _T	—	9.3	—	pF	40.0V, 1MHz

- Notes:
- 5. Device free standing no heat sink.
 - 6. Device with 50mm*50mm*23mm Al heat sink.
 - 7. Short duration pulse test used to minimize self-heating effect.

NEW PRODUCT

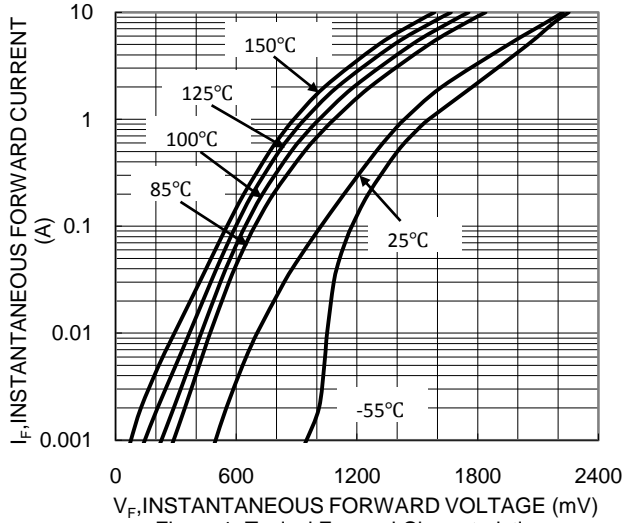

Figure 1. Typical Forward Characteristics

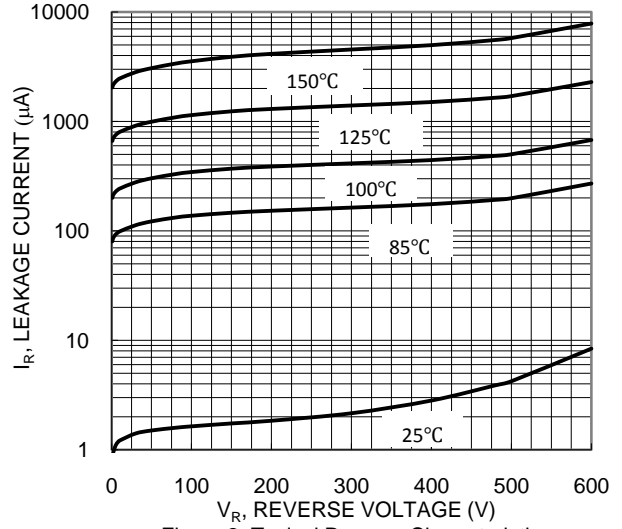

Figure 2. Typical Reverse Characteristics

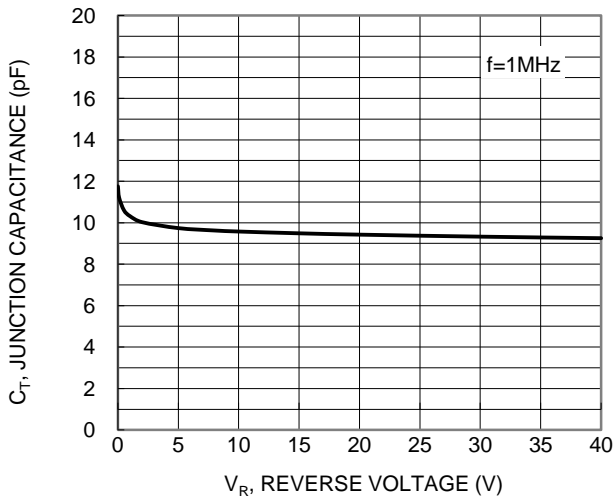

Figure 3. Typical Junction Capacitance

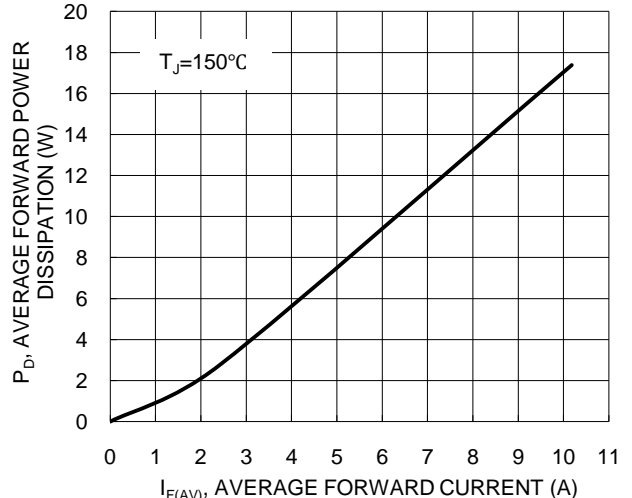

Figure 4. Forward Power Dissipation

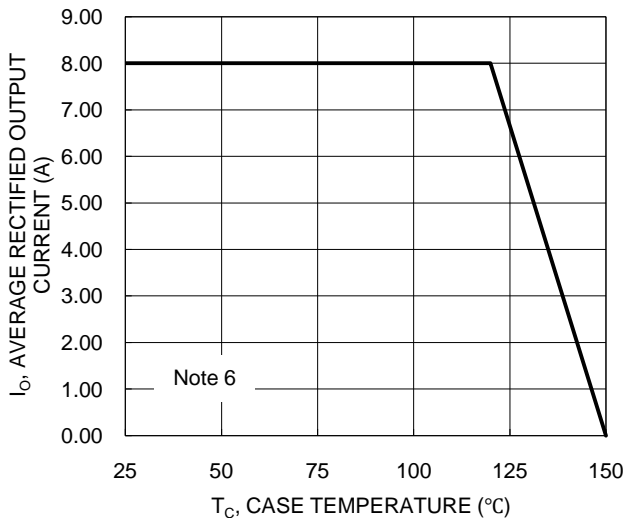

Figure 5. DC Forward Current Derating

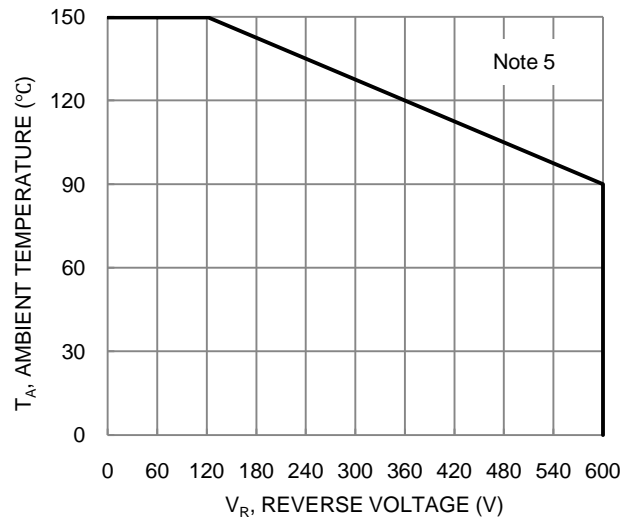

Figure 6. Operating Temperature Derating

NEW PRODUCT

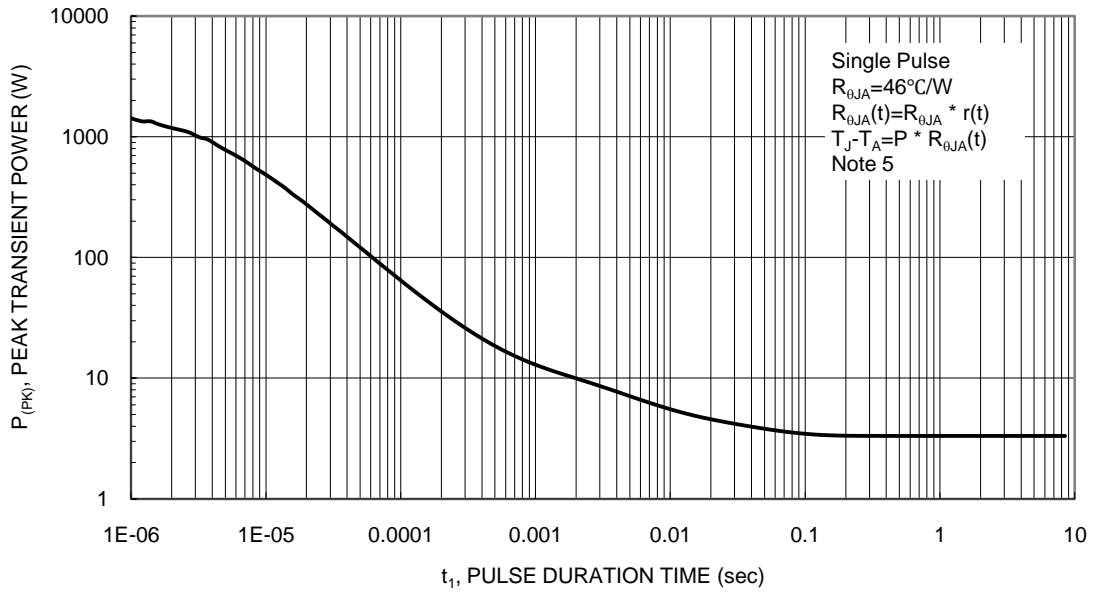

Figure 7. Single Pulse Maximum Power Dissipation

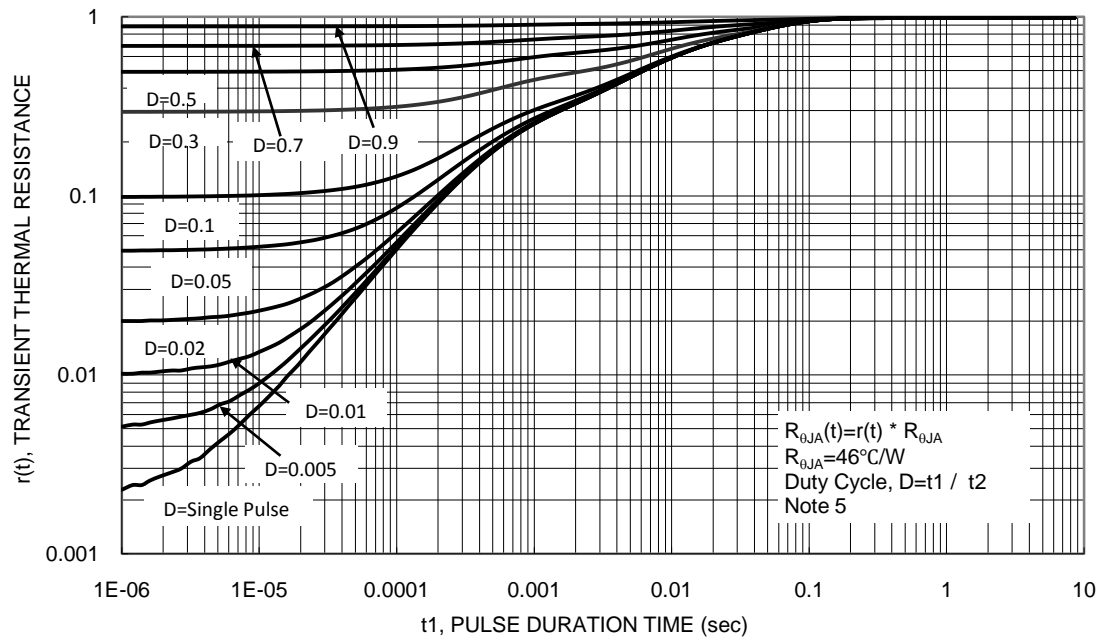
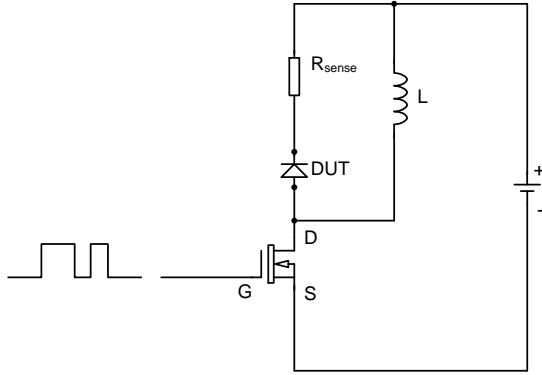
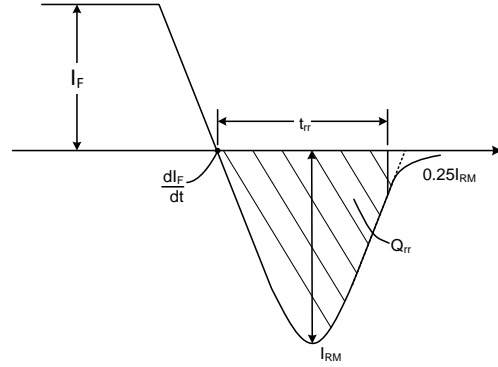

Figure 8. Transient Thermal Resistance

Test Circuit and Waveform definitions



t_{RR} Test Circuit



t_{RR} Waveform and definitions

NEW PRODUCT

Package Outline Dimensions

Please see AP02002 at <http://www.diodes.com/datasheets/ap02002.pdf> for the latest version.

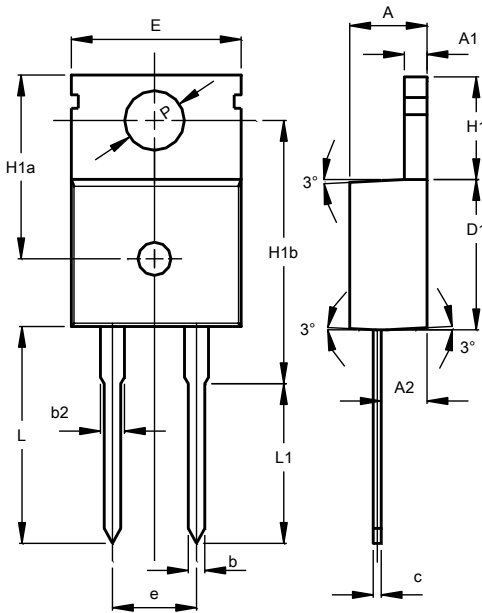

TO220AC (Type BR)			
Dim	Min	Max	Typ
A	4.30	4.70	4.50
A1	1.20	1.40	1.30
A2	2.20	2.60	2.40
b	0.70	0.90	0.80
b2	-	-	1.27
c	0.40	0.60	0.50
D1	9.00	9.40	9.20
E	9.80	10.20	10.00
e	4.88	5.28	5.08
H1	6.30	6.70	6.50
H1a	10.90	11.30	11.10
H1b	15.70	16.10	15.90
L	12.60	13.60	13.10
L1	9.60	10.60	10.10
P	3.56	3.64	3.60
All Dimensions in mm			

IMPORTANT NOTICE

DIODES INCORPORATED MAKES NO WARRANTY OF ANY KIND, EXPRESS OR IMPLIED, WITH REGARDS TO THIS DOCUMENT, INCLUDING, BUT NOT LIMITED TO, THE IMPLIED WARRANTIES OF MERCHANTABILITY AND FITNESS FOR A PARTICULAR PURPOSE (AND THEIR EQUIVALENTS UNDER THE LAWS OF ANY JURISDICTION).

Diodes Incorporated and its subsidiaries reserve the right to make modifications, enhancements, improvements, corrections or other changes without further notice to this document and any product described herein. Diodes Incorporated does not assume any liability arising out of the application or use of this document or any product described herein; neither does Diodes Incorporated convey any license under its patent or trademark rights, nor the rights of others. Any Customer or user of this document or products described herein in such applications shall assume all risks of such use and will agree to hold Diodes Incorporated and all the companies whose products are represented on Diodes Incorporated website, harmless against all damages.

Diodes Incorporated does not warrant or accept any liability whatsoever in respect of any products purchased through unauthorized sales channel. Should Customers purchase or use Diodes Incorporated products for any unintended or unauthorized application, Customers shall indemnify and hold Diodes Incorporated and its representatives harmless against all claims, damages, expenses, and attorney fees arising out of, directly or indirectly, any claim of personal injury or death associated with such unintended or unauthorized application.

Products described herein may be covered by one or more United States, international or foreign patents pending. Product names and markings noted herein may also be covered by one or more United States, international or foreign trademarks.

This document is written in English but may be translated into multiple languages for reference. Only the English version of this document is the final and determinative format released by Diodes Incorporated.

LIFE SUPPORT

Diodes Incorporated products are specifically not authorized for use as critical components in life support devices or systems without the express written approval of the Chief Executive Officer of Diodes Incorporated. As used herein:

A. Life support devices or systems are devices or systems which:

1. are intended to implant into the body, or
2. support or sustain life and whose failure to perform when properly used in accordance with instructions for use provided in the labeling can be reasonably expected to result in significant injury to the user.

B. A critical component is any component in a life support device or system whose failure to perform can be reasonably expected to cause the failure of the life support device or to affect its safety or effectiveness.

Customers represent that they have all necessary expertise in the safety and regulatory ramifications of their life support devices or systems, and acknowledge and agree that they are solely responsible for all legal, regulatory and safety-related requirements concerning their products and any use of Diodes Incorporated products in such safety-critical, life support devices or systems, notwithstanding any devices- or systems-related information or support that may be provided by Diodes Incorporated. Further, Customers must fully indemnify Diodes Incorporated and its representatives against any damages arising out of the use of Diodes Incorporated products in such safety-critical, life support devices or systems.

Copyright © 2015, Diodes Incorporated

www.diodes.com