

100mA REGULATED CHARGE PUMP**AP3602A/B****General Description**

The AP3602A/B are regulated step-up DC/DC converters based on charge pump technique. These ICs have the ability to supply 100mA constant output current or 250mA peak output current for 100ms from 3.0V to 5V input (2.7V to 4.5 V for AP3602B), so they can be used as white LEDs driver or flash LED driver.

The AP3602A/B have very low power dissipation and high efficiency in typical applications. Other features include over-temperature protection, low temperature coefficient and etc. to meet some special requirements of hand-held battery powered devices.

Only 3 external capacitors are required in applications, which helps to save space and lower cost. These chips also have a disable terminal to turn on or turn off the chip to ease the use.

The AP3602A/B are available in SOT-23-6 package.

Features

- Low Quiescent Current: 13 μ A Typical
- Regulated Output Voltage Precision: 4%
- High Output Current:
100mA when $V_{IN} \geq 3.0V$
50mA when $V_{IN} \geq 2.7V$
- High Frequency: up to 1.2 MHz
- Low Shutdown Supply Current: <1 μ A
- High Output Peak Current: 250mA for 100ms
- Over Temperature Protection
- Operating Temperature Range: -40°C to 85°C

Applications

- Mobile Phone Backlight Driver
- Camera Flash LED Driver
- MP3, MP4
- Handheld Device
- Portable Communication Device

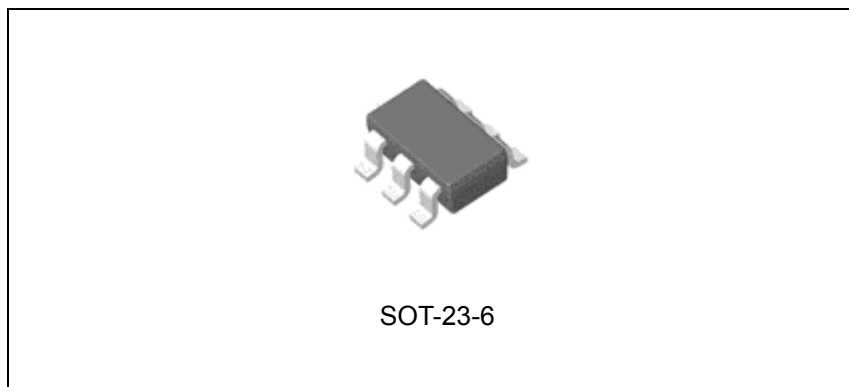

Figure 1. Package Type of AP3602A/B

100mA REGULATED CHARGE PUMP

AP3602A/B

Pin Configuration

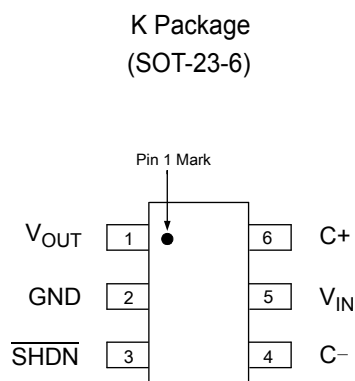

Figure 2. Pin Configuration of AP3602A/B (Top View)

Pin Description

Pin Number	Pin Name	Function
1	V _{OUT}	Regulated Output Voltage. V _{OUT} should be bypassed with a 1μF to 22μF low ESR ceramic capacitor which is placed as close to the pin as possible for best performance
2	GND	Ground. GND should be tied to a ground plane for best performance. The C _{OUT} and C _{IN} should be placed as close to this pin as possible
3	$\overline{\text{SHDN}}$	Active Low Shutdown Input. A low signal on $\overline{\text{SHDN}}$ disables the AP3602A/B, while a high signal enables the AP3602A/B. $\overline{\text{SHDN}}$ pin must not be allowed to float
4	C-	Flying Capacitor Negative Terminal. The flying capacitor should be placed as close to this pin as possible
5	V _{IN}	Input Supply Voltage. V _{IN} should be bypassed with a 1μF to 22μF low ESR ceramic capacitor which is placed as close to the pin as possible for best performance
6	C+	Flying Capacitor Positive Terminal. The flying capacitor should be placed as close to this pin as possible



100mA REGULATED CHARGE PUMP

AP3602A/B

Functional Block Diagram

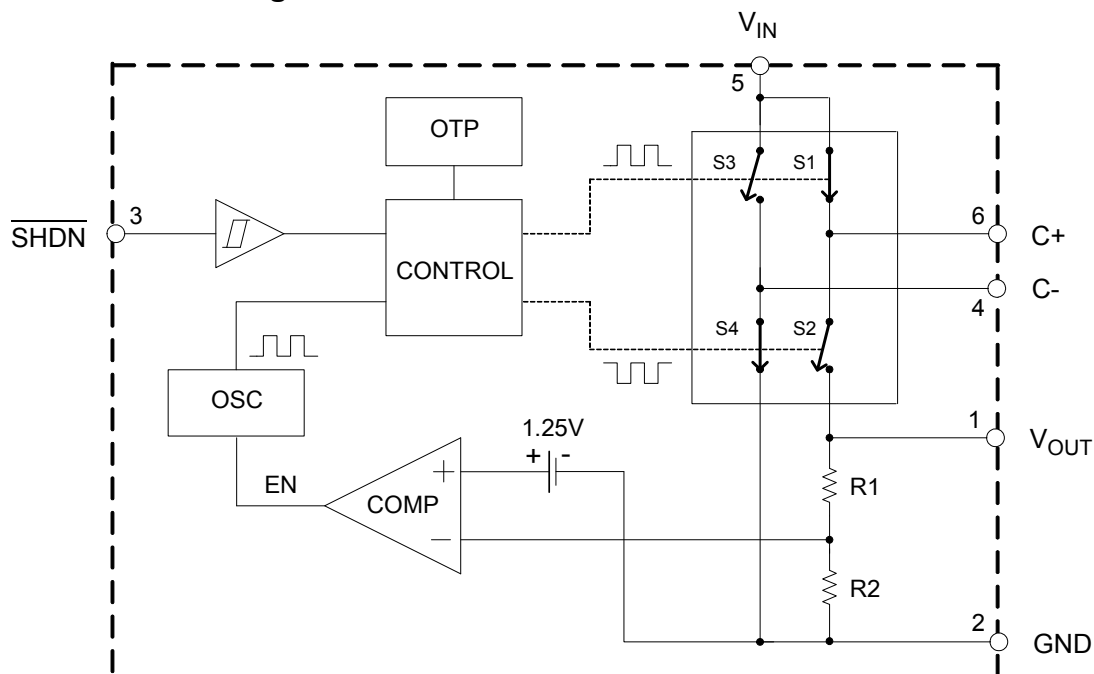
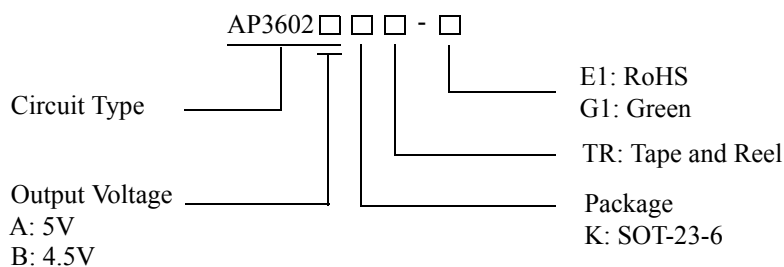

Figure 3. Functional Block Diagram of AP3602A/B

Ordering Information



Package	Temperature Range	Part Number		Marking ID		Packing Type
		RoHS	Green	RoHS	Green	
SOT-23-6	-40 to 85°C	AP3602AKTR-E1	AP3602AKTR-G1	E7T	G7T	Tape & Reel
		AP3602BKTR-E1	AP3602BKTR-G1	E8T	G8T	Tape & Reel

BCD Semiconductor's products as designated with "E1" suffix in the part number are RoHS compliant. Products with "G1" suffix are available in green packages.

**100mA REGULATED CHARGE PUMP****AP3602A/B****Absolute Maximum Ratings (Note 1)**

Parameter	Symbol	Value	Unit
Input Voltage	V_{IN}	7	V
Output Voltage	V_O	7	V
$\overline{\text{SHDN}}$ Pin Voltage	$V_{\overline{\text{SHDN}}}$	7	V
Thermal Resistance (Junction to Ambient, no Heat sink)	$R_{\theta JA}$	300	°C/W
Operating Junction Temperature	T_J	150	°C
Storage Temperature Range	T_{STG}	-65 to 150	°C
Lead Temperature (Soldering, 10sec)	T_{LEAD}	260	°C
ESD (Human Body Model)		2000	V

Note 1: Stresses greater than those listed under "Absolute Maximum Ratings" may cause permanent damage to the device. These are stress ratings only, and functional operation of the device at these or any other conditions beyond those indicated under "Recommended Operating Conditions" is not implied. Exposure to "Absolute Maximum Ratings" for extended periods may affect device reliability.

Recommended Operating Conditions

Parameter	Symbol	Min	Max	Unit	
Input Voltage	V_{IN}	AP3602A	2.7	5	V
		AP3602B	2.7	4.5	
Operating Temperature	T_A	-40	85	°C	



100mA REGULATED CHARGE PUMP

AP3602A/B

Electrical Characteristics

($C_{FLY}=1\mu F$, $C_{IN}=C_{OUT}=10\mu F$, $T_A=25^\circ C$, unless otherwise specified.)

For AP3602A

Parameter	Symbol	Conditions	Min	Typ	Max	Unit
Input Voltage	V_{IN}	$V_O=5V$	2.7		V_O	V
Quiescent Current	I_Q	$V_{IN}=2.7V$ to $5.0V$, $I_O=0mA$, $\overline{V_{SHDN}}=V_{IN}$, Not Switching		13	30	μA
Output Voltage	V_O	$2.7V < V_{IN} < 5V$, $I_O \leq 50mA$	4.8	5.0	5.2	V
		$3.0V < V_{IN} < 5V$, $I_O \leq 100mA$	4.8	5.0	5.2	
Shutdown Supply Current	$\overline{I_{SHDN}}$	$2.7V < V_{IN} < 3.6V$, $I_O=0$, $\overline{V_{SHDN}}=0V$		0.01	1	μA
		$3.6V < V_{IN} < 5.0V$, $I_O=0$, $\overline{V_{SHDN}}=0V$			2.5	
Ripple Voltage	V_{RIPPLE}	$V_{IN}=2.7V$, $I_O=50mA$		25		mV_{PP}
		$V_{IN}=3V$, $I_O=100mA$		30		
Efficiency	η	$V_{IN}=2.7V$, $I_O=50mA$		92		%
Frequency	f_{OSC}	Oscillator free running		1.2		MHz
SHDN Input Threshold High	V_{IH}		1.4			V
SHDN Input Threshold Low	V_{IL}				0.3	
SHDN Input Current High	I_{IH}	$\overline{V_{SHDN}}=V_{IN}$	-1		1	μA
SHDN Input Current Low	I_{IL}	$\overline{V_{SHDN}}=GND$	-1		1	
V_{OUT} Turn-on Time	t_{ON}	$V_{IN}=3V$, $I_O=0mA$		0.2		ms
Short-Circuit Current	I_{SC}	$V_{IN}=3V$, $V_O=GND$, $\overline{V_{SHDN}}=3V$		300		mA



100mA REGULATED CHARGE PUMP

AP3602A/B

Electrical Characteristics (Continued)

($C_{FLY}=1\mu F$, $C_{IN}=C_{OUT}=10\mu F$, $T_A=25^\circ C$, unless otherwise specified.)

For AP3602B

Parameter	Symbol	Conditions	Min	Typ	Max	Unit
Input Voltage	V_{IN}	$V_O=4.5V$	2.7		V_O	V
Quiescent Current	I_Q	$V_{IN}=2.7V$ to $4.5V$, $I_O=0mA$, $\overline{V_{SHDN}}=V_{IN}$, Not Switching		13	30	μA
Output Voltage	V_O	$2.7V < V_{IN} < 4.5V$, $I_O < 50mA$	4.32	4.5	4.68	V
		$3.0V < V_{IN} < 4.5V$, $I_O < 100mA$	4.32	4.5	4.68	
Shutdown Supply Current	$\overline{I_{SHDN}}$	$2.7V < V_{IN} < 3.6V$, $I_O=0$, $\overline{V_{SHDN}}=0V$		0.01	1	μA
		$3.6V < V_{IN} < 4.5V$, $I_O=0$, $\overline{V_{SHDN}}=0V$			2.5	
Ripple Voltage	V_{RIPPLE}	$V_{IN}=2.7V$, $I_O=50mA$		25		mV _{PP}
		$V_{IN}=3V$, $I_O=100mA$		30		
Efficiency	η	$V_{IN}=2.7V$, $I_O=50mA$		83		%
Frequency	f_{OSC}	Oscillator free running		1.2		MHz
SHDN Input Threshold High	V_{IH}		1.4			V
SHDN Input Threshold Low	V_{IL}				0.3	
SHDN Input Current High	I_{IH}	$\overline{V_{SHDN}}=V_{IN}$	-1		1	μA
SHDN Input Current Low	I_{IL}	$\overline{V_{SHDN}}=0V$	-1		1	
V_{OUT} Turn-on Time	t_{ON}	$V_{IN}=3V$, $I_O=0mA$		0.2		ms
Short-Circuit Current	I_{SC}	$V_{IN}=3V$, $V_O=GND$, $\overline{V_{SHDN}}=3V$		300		mA

**100mA REGULATED CHARGE PUMP****AP3602A/B****Application Information****Operating Principles**

The AP3602A/B use a switched capacitor charge pump to boost the input voltage to a regulated output voltage. Regulation is achieved by sensing the chip output voltage through an internal resistor divider network. Controlled by an internal comparator (refer to the functional block diagram), the charge pump circuit is enabled when the divided output voltage is below a preset trip point .

The charge pump operates at 1.2MHz with 50% duty cycle. Conversion consists of a two-phase operation. In the first phase, switches S2 and S3 are opened and S1 and S4 are closed. During this time, C_{FLY} charges to the voltage on V_{IN} and load current is supplied by C_{OUT} . During the second phase, S2 and S3 are closed, and S1 and S4 are opened. This action connects C_{FLY} low side to V_{IN} , C_{FLY} high side to V_{OUT} , then a voltage about $2*V_{IN}$ is used to charge C_{OUT} and supply the load current. For each cycle, charges is transported from V_{IN} to V_{OUT} to maintain the output voltage in its nominal value.

This process breaks when the V_{OUT} is high enough for the reason of higher input voltage or lower load, then the divided voltage at the control comparator exceeds the internal trip point high level, which compels the charge pump circuit enter to the idle mode in which the switching cycle stops (pulse skipping) and the output voltage is continually decreased because it is maintained by the discharging of C_{OUT} only. In idle mode, the feedback circuit continues sensing V_{OUT} . If the

divided voltage at the control comparator drops below the preset trip point, the comparator will start the switching cycle again.

In idle mode, the AP3602A/B's quiescent current is about $13\mu A$. In shutdown mode, all internal circuitry is turned off and the AP3602A/B draw only leakage current from V_{IN} , which is less than $1\mu A$. So, the shutdown power loss for AP3602A/B is very low, that is beneficial to the battery supplied systems.

Short Circuit and Thermal Protection

The AP3602A/B have a thermal protection and shutdown circuit that continuously monitors the IC junction temperature.

When output short circuit occurs, the short circuit current is about 300mA (Typical). Under this condition, the I_{IN} is about $2*I_{out}$, which causes about 1.8W instant power dissipation on AP3602A/B, that will cause a rise in the internal IC junction temperature. If the thermal protection circuit senses the junction temperature exceeding approximately $160^{\circ}C$, the thermal shutdown circuit will disable the charge pump switching circuit. The thermal hysteresis is about $10^{\circ}C$, which means that the charge pump circuit can be active when the short circuit is removed and the junction temperature drops below $150^{\circ}C$.

The thermal shutdown protection will cycle on and off if an output short circuit condition persists. This will allow the AP3602A/B to operate on a short circuit condition without latch up or damage to the device.



100mA REGULATED CHARGE PUMP

AP3602A/B

Typical Performance Characteristics

Typical Performance Characteristics for AP3602A

(Unless otherwise noted, $V_{IN}=3.0V$, $C_{IN}=C_{OUT}=10\mu F$, $C_{FLY}=1\mu F$ Ceramic Cap, $T_A=25^\circ C$)

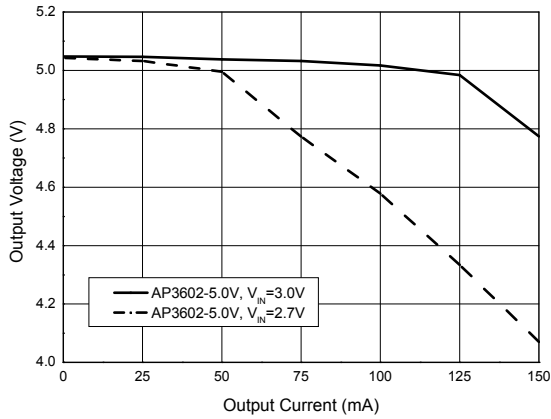

Figure 4. Output Voltage vs. Output Current

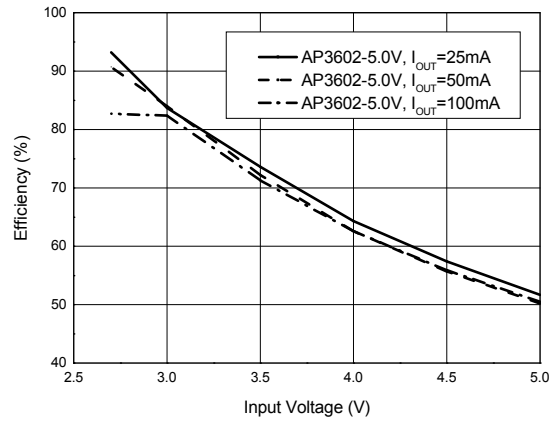

Figure 5. Efficiency vs. Input Voltage

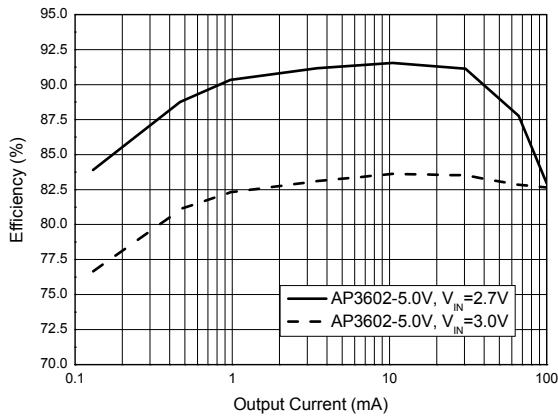

Figure 6. Efficiency vs. Output Current

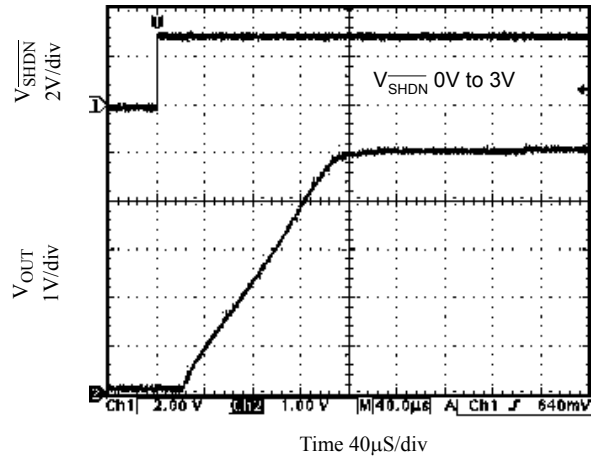

Figure 7. V_{OUT} Start UpTime, @ No Load

100mA REGULATED CHARGE PUMP

AP3602A/B

Typical Performance Characteristics (Continued)

Typical Performance Characteristics for AP3602A (Continued)

(Unless otherwise noted, $V_{IN}=3.0V$, $C_{IN}=C_{OUT}=10\mu F$, $C_{FLY}=1\mu F$ Ceramic Cap, $T_A=25^\circ C$)

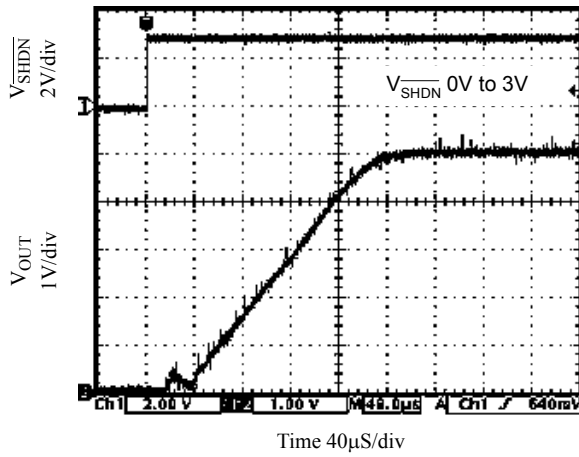

Figure 8. V_{OUT} Start Up Time, @ 50mA Load

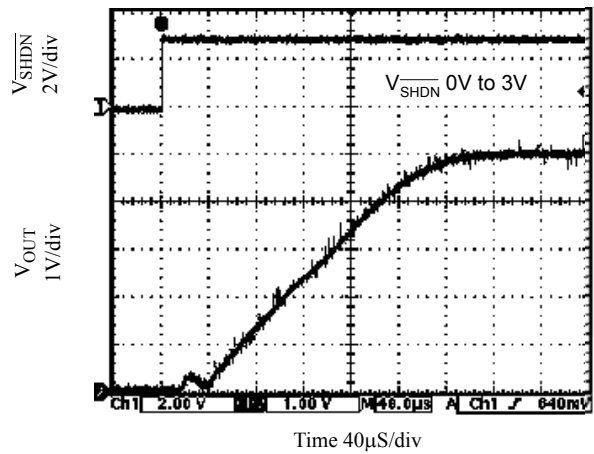

Figure 9. V_{OUT} Start Up Time, @ 100mA Load

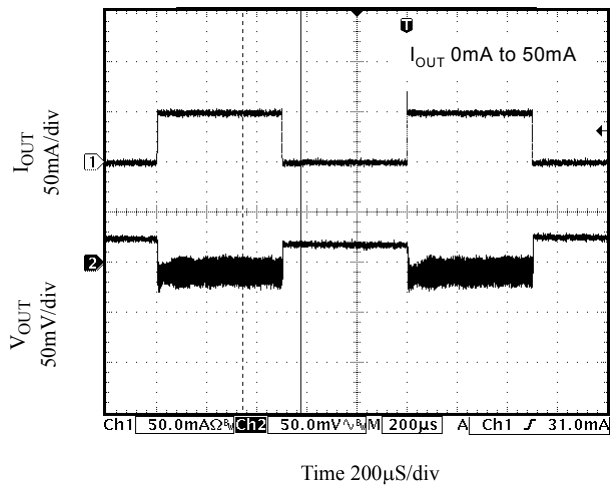

Figure 10. Load Transient Response

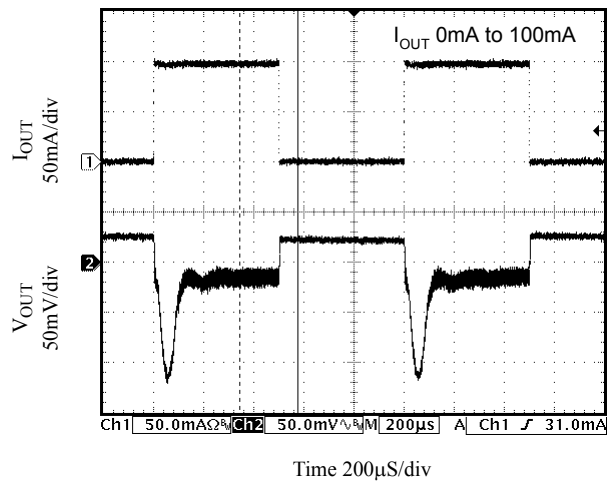

Figure 11. Load Transient Response

100mA REGULATED CHARGE PUMP

AP3602A/B

Typical Performance Characteristics (Continued)

Typical Performance Characteristics for AP3602A (Continued)

(Unless otherwise noted, $V_{IN}=3.0V$, $C_{IN}=C_{OUT}=10\mu F$, $C_{FLY}=1\mu F$ Ceramic Cap, $T_A=25^\circ C$)

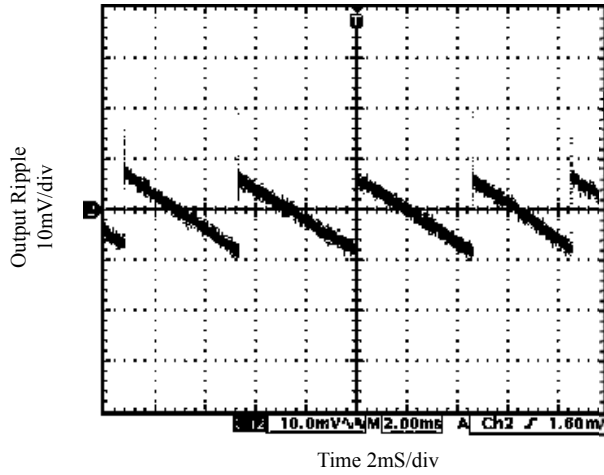

Figure 12. Output Ripple @ $V_{IN}=2.7V$, $I_{OUT}=0mA$

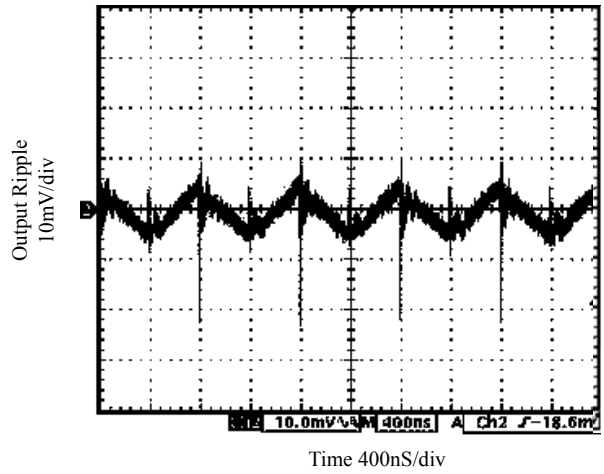

Figure 13. Output Ripple @ $V_{IN}=2.7V$, $I_{OUT}=50mA$

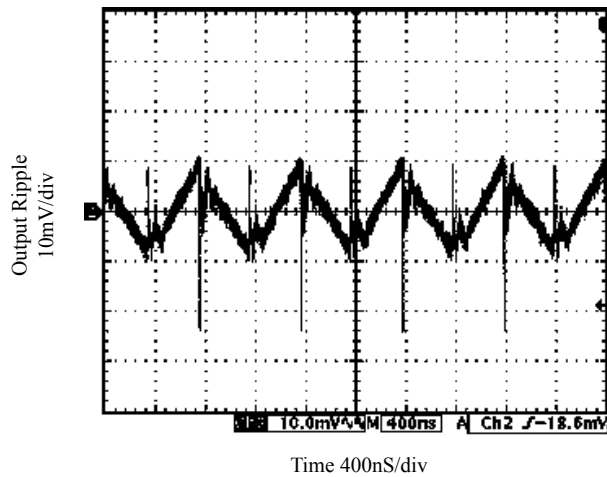

Figure 14. Output Ripple @ $V_{IN}=2.7V$, $I_{OUT}=100mA$

100mA REGULATED CHARGE PUMP

AP3602A/B

Typical Performance Characteristics (Continued)

Typical Performance Characteristics for AP3602B

(Unless otherwise noted, $V_{IN}=3.0V$, $C_{IN}=C_{OUT}=10\mu F$, $C_{FLY}=1\mu F$ Ceramic Cap, $T_A=25^\circ C$)

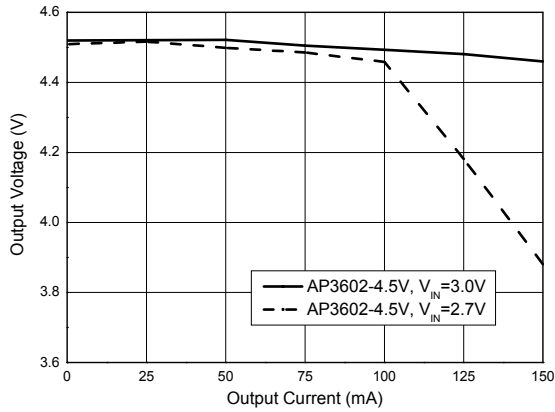

Figure 15. Output Voltage vs. Output Current

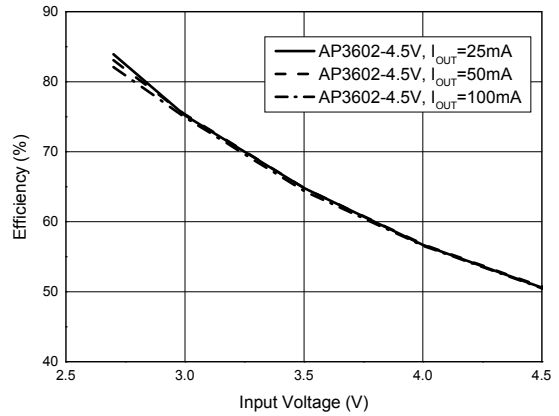

Figure 16. Efficiency vs. Input Voltage

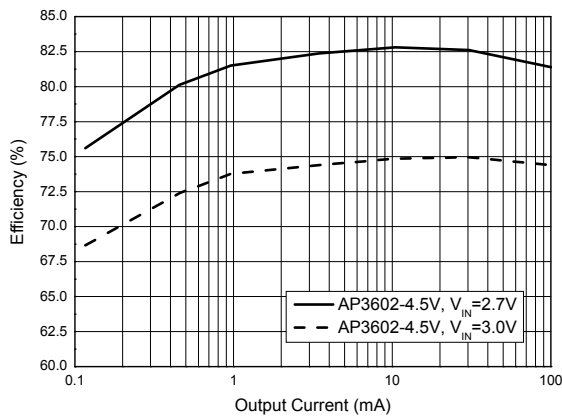

Figure 17. Efficiency vs. Output Current

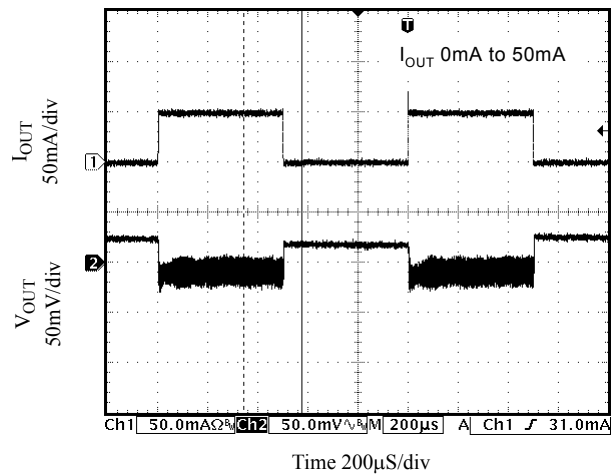

Figure 18. Load Transient Response



100mA REGULATED CHARGE PUMP

AP3602A/B

Typical Performance Characteristics (Continued)

Typical Performance Characteristics for AP3602B (Continued)

(Unless otherwise noted, $V_{IN}=3.0V$, $C_{IN}=C_{OUT}=10\mu F$, $C_{FLY}=1\mu F$ Ceramic Cap, $T_A=25^\circ C$)

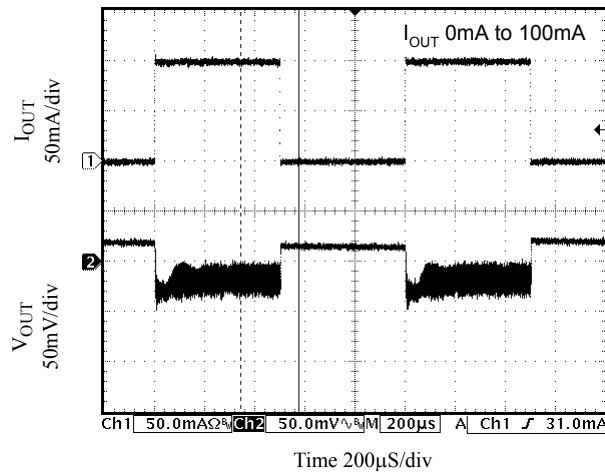

Figure 19. Load Transient Response

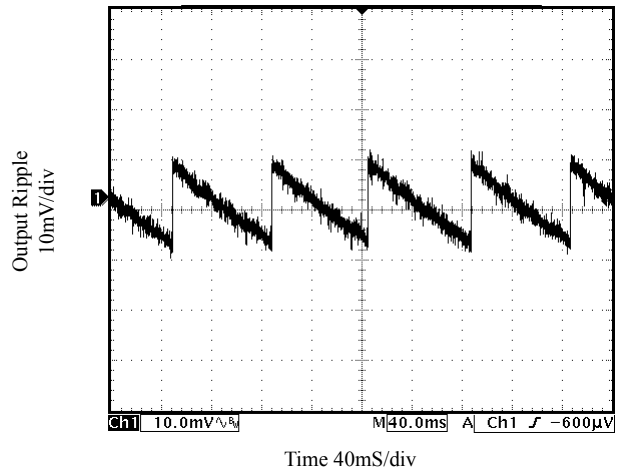

Figure 20. Output Ripple @ $V_{IN}=2.7V$, $I_{OUT}=0mA$

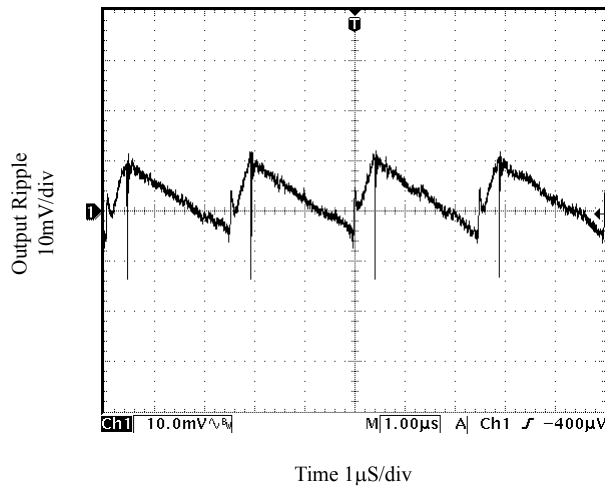

Figure 21. Output Ripple @ $V_{IN}=2.7V$, $I_{OUT}=50mA$

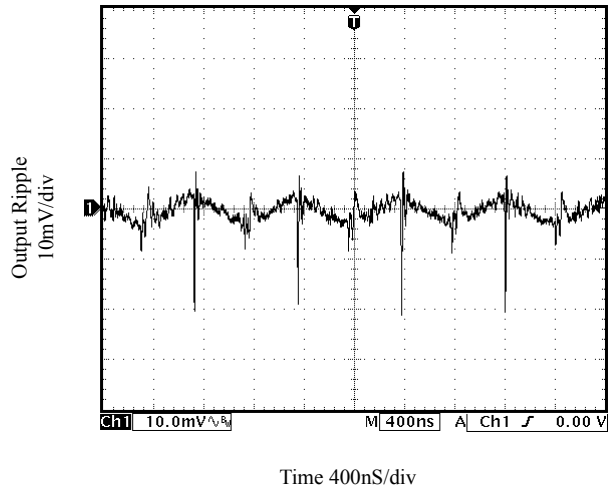

Figure 22. Output Ripple @ $V_{IN}=2.7V$, $I_{OUT}=100mA$



100mA REGULATED CHARGE PUMP

AP3602A/B

Typical Performance Characteristics (Continued)

Typical Performance Characteristics for AP3602A/B

(Unless otherwise noted, $V_{IN}=3.0V$, $C_{IN}=C_{OUT}=10\mu F$, $C_{FLY}=1\mu F$ Ceramic Cap, $T_A=25^\circ C$)

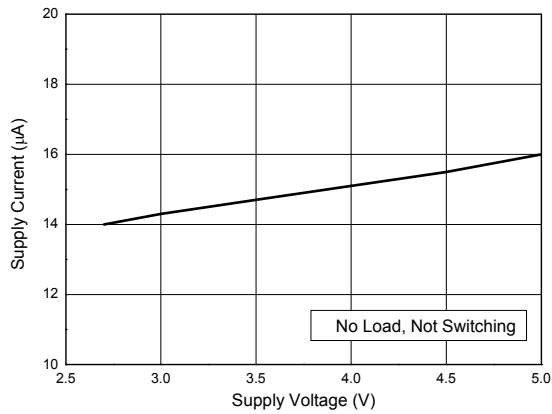

Figure 23. Supply Current vs. Supply Voltage

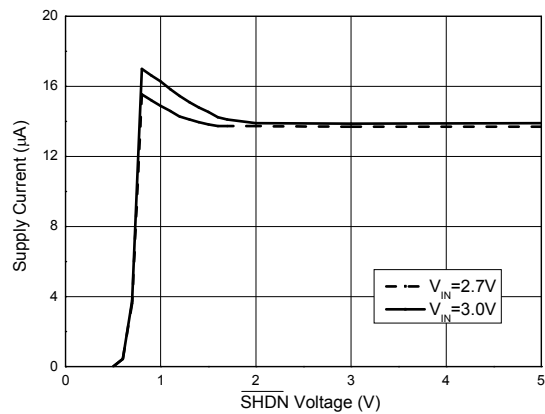

Figure 24. Supply Current vs. \overline{SHDN} Voltage

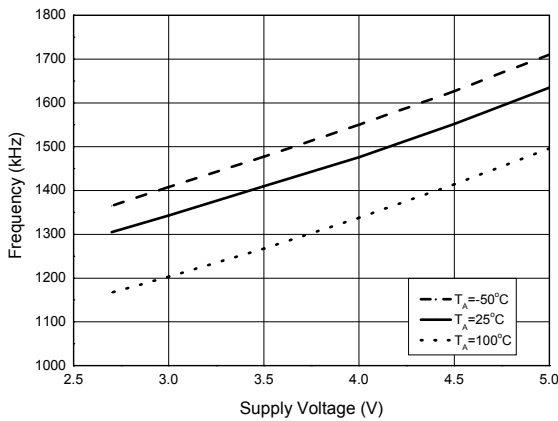

Figure 25. Oscillator Frequency vs. Supply Voltage

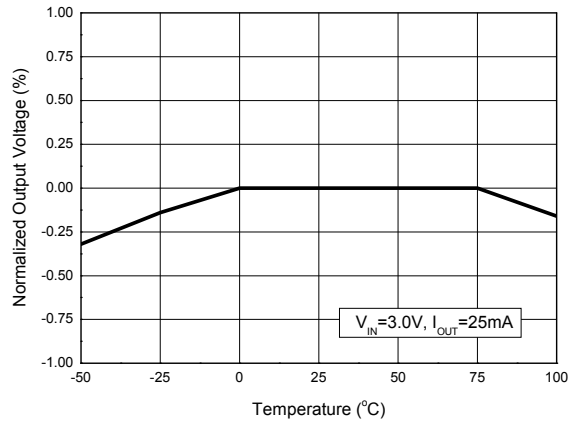

Figure 26. Normalized Output Voltage vs. Temperature



100mA REGULATED CHARGE PUMP

AP3602A/B

Typical Performance Characteristics (Continued)

Typical Performance Characteristics for AP3602A/B (Continued)

(Unless otherwise noted, $V_{IN}=3.0V$, $C_{IN}=C_{OUT}=10\mu F$, $C_{FLY}=1\mu F$ Ceramic Cap, $T_A=25^\circ C$)

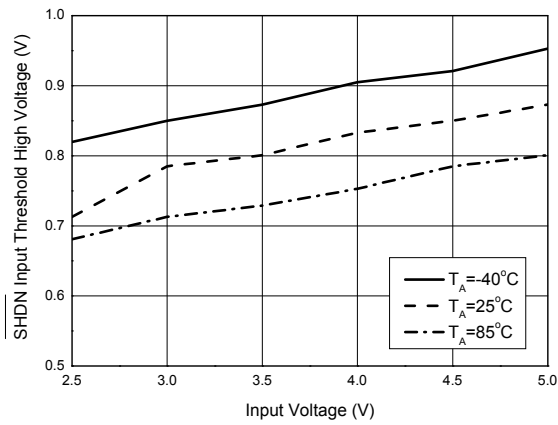

Figure 27. V_{IH} vs. V_{IN}

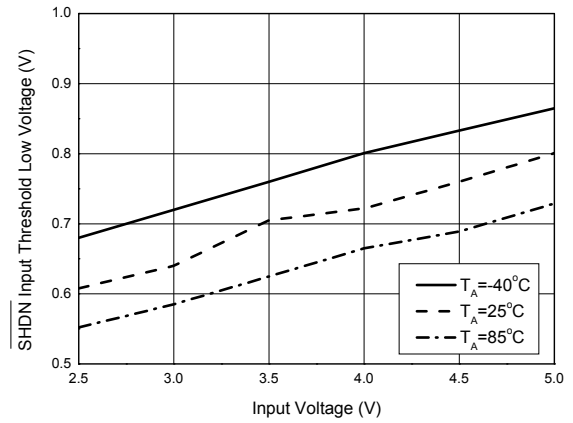

Figure 28. V_{IL} vs. V_{IN}

100mA REGULATED CHARGE PUMP

AP3602A/B

Typical Application

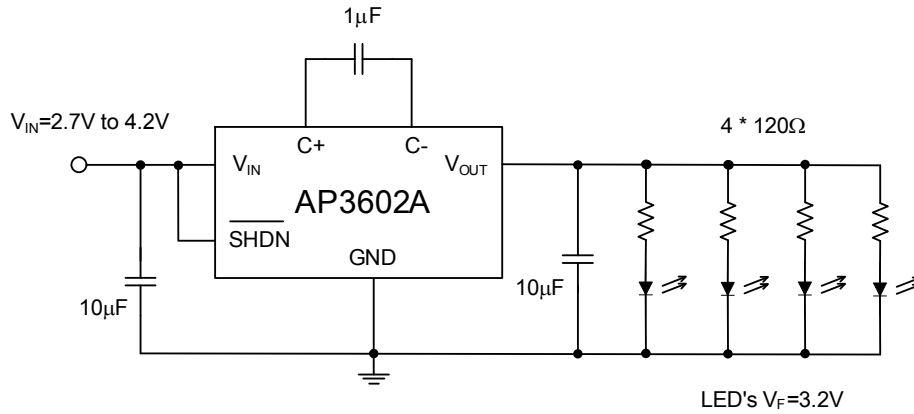

Figure 29. AP3602A Typical Application Circuit

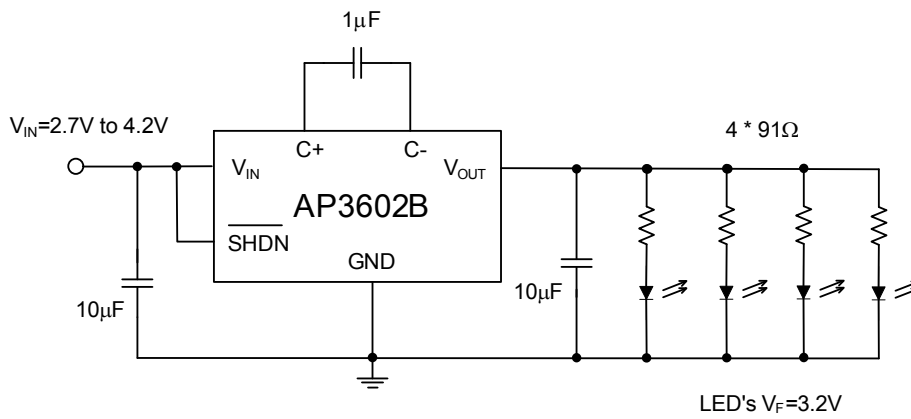

Figure 30. AP3602B Typical Application Circuit



100mA REGULATED CHARGE PUMP

AP3602A/B

Mechanical Dimensions

SOT-23-6

Unit: mm(inch)

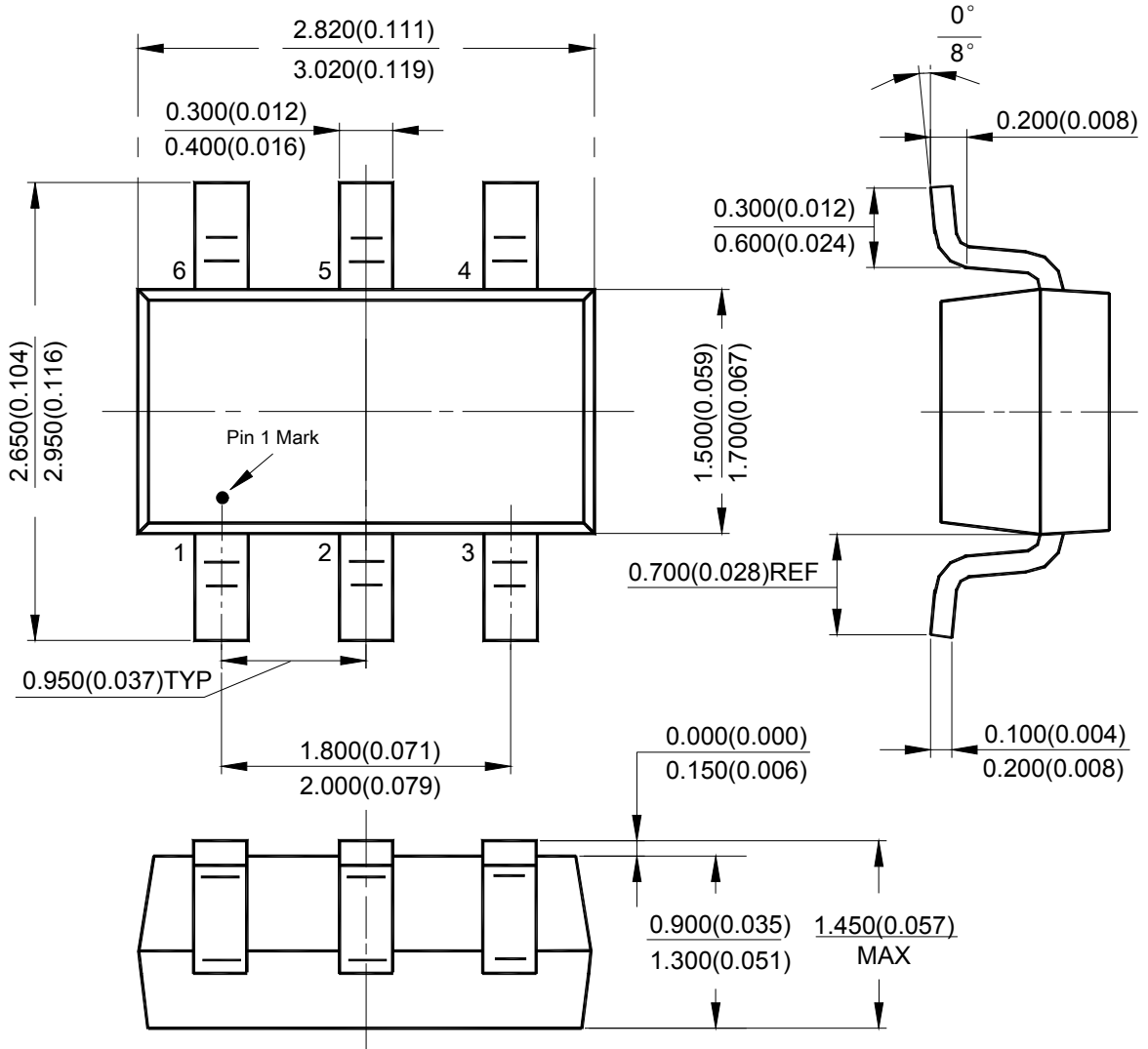



BCD Semiconductor Manufacturing Limited

<http://www.bcdsemi.com>

IMPORTANT NOTICE

BCD Semiconductor Manufacturing Limited reserves the right to make changes without further notice to any products or specifications herein. BCD Semiconductor Manufacturing Limited does not assume any responsibility for use of any its products for any particular purpose, nor does BCD Semiconductor Manufacturing Limited assume any liability arising out of the application or use of any its products or circuits. BCD Semiconductor Manufacturing Limited does not convey any license under its patent rights or other rights nor the rights of others.

MAIN SITE

- Headquarters

BCD Semiconductor Manufacturing Limited

No. 1600, Zi Xing Road, Shanghai Zizhu Science-based Industrial Park, 200241, China
Tel: +86-21-24162266, Fax: +86-21-24162277

- Wafer Fab

Shanghai SIM-BCD Semiconductor Manufacturing Co., Ltd.

800 Yi Shan Road, Shanghai 200233, China
Tel: +86-21-6485 1491, Fax: +86-21-5450 0008

REGIONAL SALES OFFICE

Shenzhen Office

Shanghai SIM-BCD Semiconductor Manufacturing Co., Ltd., Shenzhen Office

Unit A Room 1203, Skyworth Bldg., Gaoxin Ave. 1.S., Nanshan District, Shenzhen, China
Tel: +86-755-8826 7951
Fax: +86-755-8826 7865

Taiwan Office

BCD Semiconductor (Taiwan) Company Limited

4F, 298-1, Rui Guang Road, Nei-Hu District, Taipei, Taiwan
Tel: +886-2-2656 2808
Fax: +886-2-2656 2806

USA Office

BCD Semiconductor Corp.

30920 Huntwood Ave. Hayward, CA 94544, USA
Tel : +1-510-324-2988
Fax: +1-510-324-2788