

## Single Phase Synchronous Buck PWM Controller

## AP3581A/B/C

## General Description

The AP3581A/B/C is a compact synchronous-rectified buck controller specifically designed to operate from 5V/12V supply and deliver high-quality output voltage as low as 0.6V (AP3581A) or 0.8V (AP3581B/C). The AP3581A/B/C operates at fixed frequency of 300kHz (AP3581A/B) or 200kHz (AP3581C) and provides an optimal level of integration to reduce size and cost of the power supply.

This controller integrates internal MOSFET drivers that support 12V+12V bootstrapped voltage for high-efficiency power conversion. The bootstrap diode is built-in to simplify the circuit design and minimize external part count.

This controller provides single feedback loop, voltage-mode control with fast transient response. The error amplifier features a 10MHz gain-bandwidth product and 6V/ $\mu$ s slew rate which enables high converter bandwidth for fast transient performance.

Other features include internal soft-start, under voltage protection, over current protection and shutdown function. With afore-mentioned functions, this part provides customers a compact, high efficiency, well-protected and cost-effective solutions.

The AP3581A/B/C is available in PSOP-8 package.

## Features

- Supply Voltage: 5V/12V  
V<sub>IN</sub> Input Range: 3.0V to 13.2V  
0.6V/0.8V to 80% of V<sub>IN</sub> Output Range  
Internal Reference: 0.6V/0.8V
- Simple Single-loop Control  
Voltage-mode PWM Control  
Duty Cycle: 0% to 80%  
Fast Transient Response
- 10MHz High-bandwidth Error Amplifier with 6V/ $\mu$ s Slew Rate
- Fixed Oscillator Frequency: 300kHz/200kHz
- Lossless, Programmable Over Current Protection (Uses Lower MOSFET R<sub>DS(ON)</sub>)
- Start-up into Pre-biased Output
- Built-in Thermal Shutdown
- Built-in Soft-start
- Over Current/Voltage Protection
- Under Voltage Protection
- Integrated Boot Diode

## Applications

- Power Supplies for Microprocessors/Peripherals  
PCs, Embedded Controllers, Memory Supplies  
DSP and Core Communications Processor  
Supplies
- Subsystem Power Supplies  
PCI, AGP, Graphics Cards, Digital TV  
SSTL-2 and DDR/2/3 SDRAM Bus Termination  
Supply
- Cable Modems, Set Top Boxes, and DSL  
Modems
- Industrial Power Supplies and General Purpose  
Supplies
- 5V/12V Input DC-DC Regulators
- Low-voltage Distributed Power Supplies



Figure 1. Package Type of AP3581A/B/C

**Single Phase Synchronous Buck PWM Controller**
**AP3581A/B/C**
**Pin Configuration**

Figure 2. Pin Configuration of AP3581A/B/C (Top View)

**Pin Description**

Pin Number	Pin Name	Function
1	BOOT	Bootstrap pin. Connect a bootstrap capacitor (Typically from 0.1 $\mu$ F to 0.47 $\mu$ F) from this pin to PHASE pin to create a BOOT voltage suitable to drive a standard N-Channel MOSFET
2	UGATE	Upper-gate drive pin. Connect this pin to the upper MOSFET gate providing the gate drive. This pin is monitored by the adaptive shoot-through protection circuitry to determine when the upper MOSFET has been turned off
3	OPS	Over-current setting pin. Connecting a resistor ( $R_{OCSET}$ ) between OPS and GND to set the over-current trigger point
4	LGATE	Lower-gate drive pin. Connect LGATE to the lower MOSFET gate providing the gate drive for the lower MOSFET. This pin is monitored by the adaptive shoot-through protection circuitry to determine when the lower MOSFET has turned off
5	VCC	Bias supply pin. Provides a 5V or 12V bias supply for the chip from this pin. The pin should be bypassed with a capacitor to GND
6	FB	Feedback pin. This pin is the inverting input of the internal error amplifier. Use FB pin, in combination with the COMP pin, to compensate the voltage control feedback loop of the converter. A resistor divider from output to GND is used to set the output voltage
7	COMP/EN	Compensation and disable pin, this pin is the output of the error amplifier. Pull COMP pin low will shut down the IC
8	PHASE	PHASE pin. This pin connects to the source of the upper MOSFET and the drain of the lower MOSFET. This pin is also monitored by the adaptive shoot-through protection circuitry to determine when the upper MOSFET has turned off
9	GND	Exposed pad as ground pin. Represents the signal and power ground for the IC. Tie this pin to the ground island/plane through the lowest impedance connection available

**Single Phase Synchronous Buck PWM Controller**

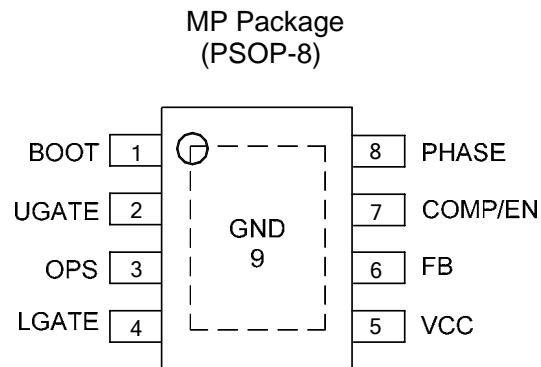
**AP3581A/B/C**

**Functional Block Diagram**

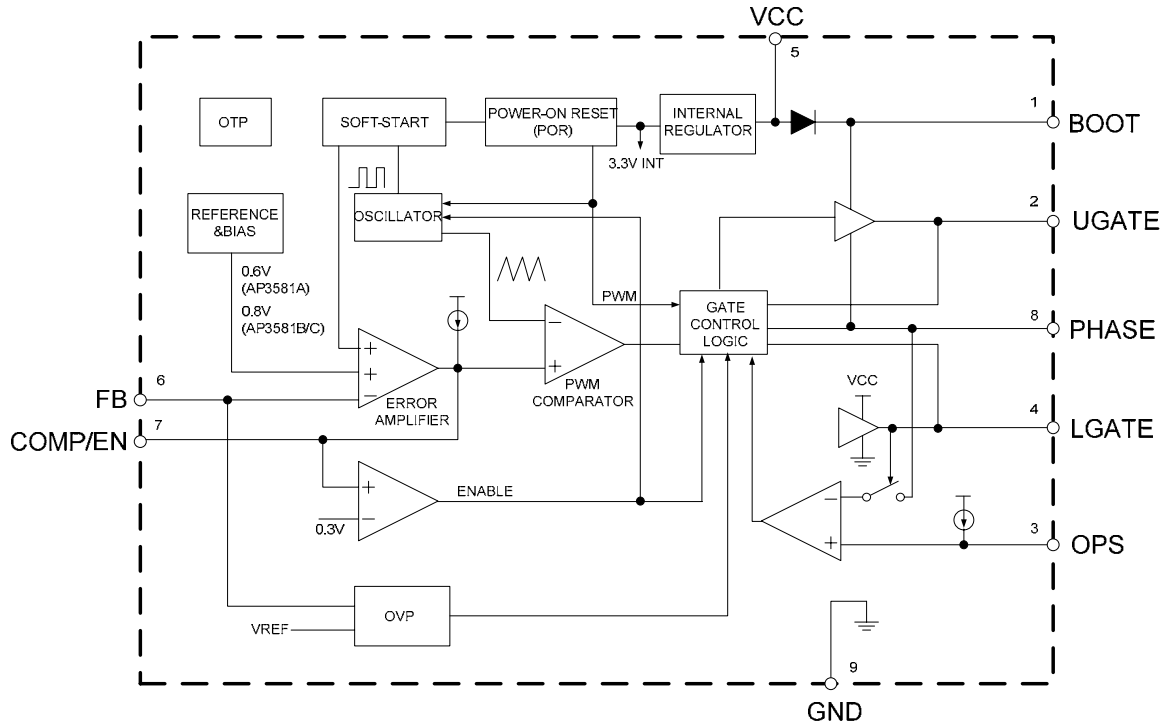
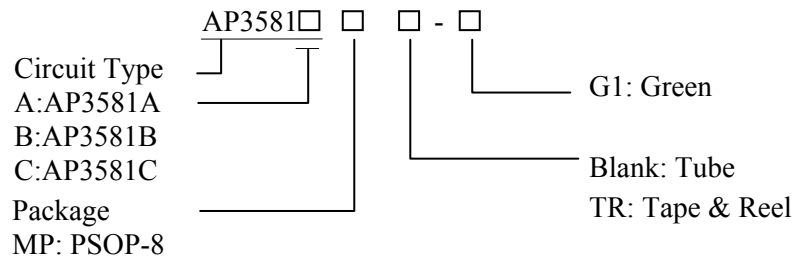

Figure 3. Functional Block Diagram of AP3581A/B/C

**Ordering Information**



Package	Temperature Range	Part Number	Marking ID	Packing Type
PSOP-8	-40 to 85°C	AP3581AMP-G1	3581AMP-G1	Tube
		AP3581AMPTR-G1	3581AMP-G1	Tape & Reel
		AP3581BMP-G1	3581BMP-G1	Tube
		AP3581BMPTR-G1	3581BMP-G1	Tape & Reel
		AP3581CMP-G1	3581CMP-G1	Tube
		AP3581CMPTR-G1	3581CMP-G1	Tape & Reel

BCD Semiconductor's Pb-free products, as designated with "G1" suffix in the part number, are RoHS compliant and green.

**Single Phase Synchronous Buck PWM Controller****AP3581A/B/C****Absolute Maximum Ratings (Note 1)**

Parameter	Symbol	Value	Unit
Supply Voltage	$V_{CC}$	-0.3 to 15	V
BOOT Voltage	$V_{BOOT}$	-0.3 to $V_{PHASE} +15$	V
Voltage from UGATE to PHASE	$V_{UGATE}$	-0.3 to 15	V
Voltage from PHASE, LGATE Pin to GND	$V_{PHASE}$ , $V_{LGATE}$	-1 to 15	V
Voltage on Other Separate Pin		-0.3 to 6	V
Thermal Resistance	$\theta_{JA}$	50	°C/W
Operating Junction Temperature	$T_J$	-40 to 125	°C
Storage Temperature	$T_{STG}$	-65 to 150	°C
Lead Temperature (Soldering, 10 sec)	$T_{LEAD}$	260	°C
ESD (Human Body Model) (Note 2)		2000	V
ESD (Machine Model) (Note 2)		200	V

Note 1: Stresses greater than those listed under “Absolute Maximum Ratings” may cause permanent damage to the device. These are stress ratings only, and functional operation of the device at these or any other conditions beyond those indicated under “Recommended Operating Conditions” is not implied. Exposure to “Absolute Maximum Ratings” for extended periods may affect device reliability.

Note 2: Devices are ESD sensitive. Handling precaution recommended.

**Recommended Operating Conditions**

Parameter	Symbol	Min	Max	Unit
Supply Input Voltage	$V_{CC}$	4.5	13.2	V
Operating Junction Temperature Range	$T_J$	-40	125	°C
Operating Ambient Temperature	$T_A$	-40	85	°C



**Single Phase Synchronous Buck PWM Controller**

**AP3581A/B/C**

**Electrical Characteristics**

$V_{CC}=12V$ ,  $T_A=25^{\circ}C$ , unless otherwise specified.

Parameter	Symbol	Conditions	Min	Typ	Max	Unit
<b>SUPPLY INPUT</b>						
Supply Voltage	$V_{CC}$		4.5		13.2	V
Supply Current	$I_{CC}$	UGATE and LGATE Pin Open; $V_{CC}=12V$ , Switching		5		mA
Quiescent Supply Current	$I_{CC\_Q}$	$V_{FB}=V_{REF}+0.1V$ , No Switching		4		mA
Power Input Voltage	$V_{IN}$		3.0		13.2	V
<b>POWER ON RESET</b>						
$V_{CC}$ Rising Threshold	$V_{POR}$	$V_{CC}$ Rising	4.0	4.2	4.4	V
$V_{CC}$ Threshold Hysteresis	$V_{POR\_HYS}$			500		mV
<b>OSCILLATOR</b>						
Oscillator Frequency	$f_{OSC}$	AP3581A/B	270	300	330	kHz
		AP3581C	180	200	220	
Ramp Amplitude	$\Delta V_{OSC}$	$V_{CC}=12V$		1.8		V
<b>ERROR AMPLIFIER</b>						
Open Loop DC Gain (Note 3)	$G_{DC\_OL}$		55	70		dB
Gain Bandwidth (Note 3)	$G_{BW}$			10		MHz
Slew Rate (Note 3)	SR		3	6		V/ $\mu$ s
Transconductance				800	1100	$\mu$ A/V
Output Source Current		$V_{FB}<V_{REF}$	80	120		$\mu$ A
Output Sink Current		$V_{FB}>V_{REF}$	80	120		$\mu$ A
<b>PWM CONTROLLER GATE DRIVERS</b>						
Upper Gate Source Current	$I_{UG\_SRC}$	$V_{BOOT}-V_{PHASE}=12V$ , $V_{BOOT}-V_{UGATE}=6V$		-1		A
Upper Gate Sink Current	$I_{UG\_SNK}$	$V_{BOOT}-V_{PHASE}=12V$ , $V_{BOOT}-V_{UGATE}=6V$		1.5		A
Upper Gate Sink Resistance	$R_{UGATE}$	50mA Sink Current, $V_{BOOT}-V_{PHASE}=12V$		1.6	3.2	$\Omega$
Lower Gate Source Current	$I_{LG\_SRC}$	$V_{CC}-V_{LGATE}=6V$		-1		A
Lower Gate Sink Current	$I_{LG\_SNK}$	$V_{LGATE}=6V$		1.5		A
Lower Gate Sink Resistance	$R_{LGATE}$	50mA Sink Current, $V_{CC}=12V$		1	2	$\Omega$
PHASE Falling to LGATE Rising Delay		$V_{PHASE}<1.2V$ to $V_{LGATE}>1.2V$		50		ns

**Single Phase Synchronous Buck PWM Controller**

**AP3581A/B/C**

**Electrical Characteristics (Continued)**

$V_{CC}=12V, T_A=25^{\circ}C$ , unless otherwise specified.

Parameter	Symbol	Conditions	Min	Typ	Max	Unit
LGATE Falling to UGATE Rising Delay		$V_{LGATE}<1.2V$ to $(V_{UGATE}-V_{PHASE})>1.2V$		50		ns
Minimum Duty Cycle				0		%
Maximum Duty Cycle			75	80	85	%
<b>REFERENCE VOLTAGE</b>						
Feedback Voltage	$V_{FB}$	AP3581A	0.591	0.6	0.609	V
		AP3581B/C	0.788	0.8	0.812	V
<b>PROTECTION</b>						
Under Voltage Protection	$V_{FB\_UVP}$		0.3	0.4	0.5	V
Over Current Source	$I_{OPS}$		30	40	50	$\mu A$
Soft-start Interval	$t_{SS}$	AP3581A		2.0		ms
		AP3581B		2.7		
		AP3581C		3.6		
Enable Threshold	$V_{COMP/EN}$		0.25	0.30	0.35	V
Thermal Shutdown	$T_{OTSD}$			160		$^{\circ}C$
Thermal Shutdown Hysteresis	$T_{HYS}$			20		$^{\circ}C$

Note 3: Not tested, guaranteed by design.

**Typical Performance Characteristics**

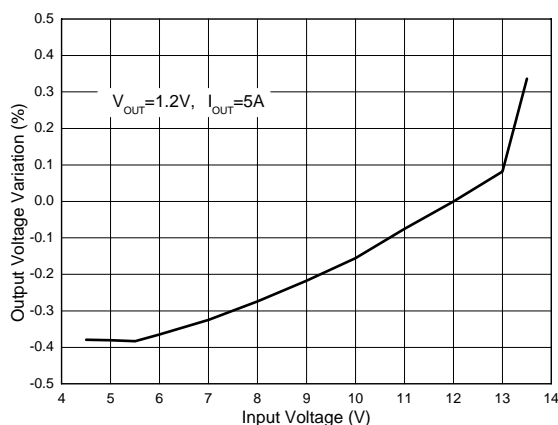

Figure 4. Line Regulation

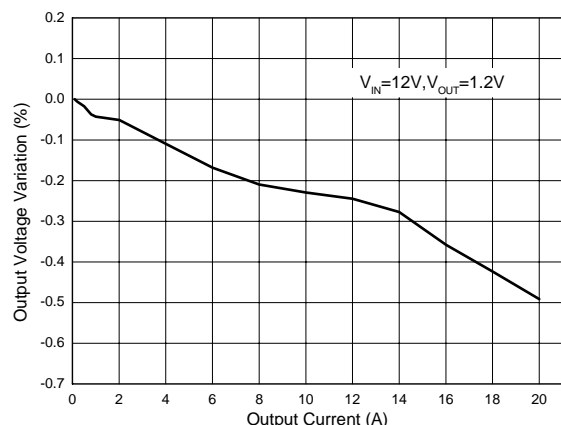

Figure 5. Load Regulation

**Single Phase Synchronous Buck PWM Controller**

**AP3581A/B/C**

**Typical Performance Characteristics (Continued)**

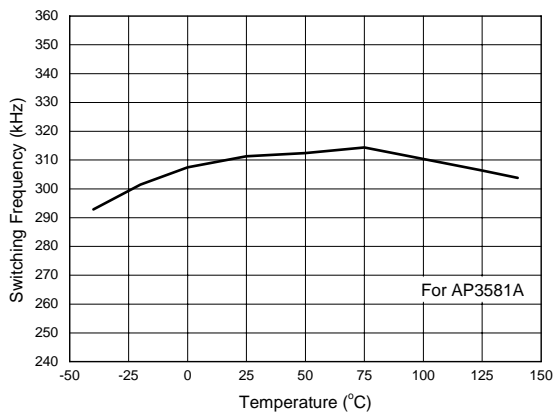

Figure 6. Switching Frequency vs. Temperature

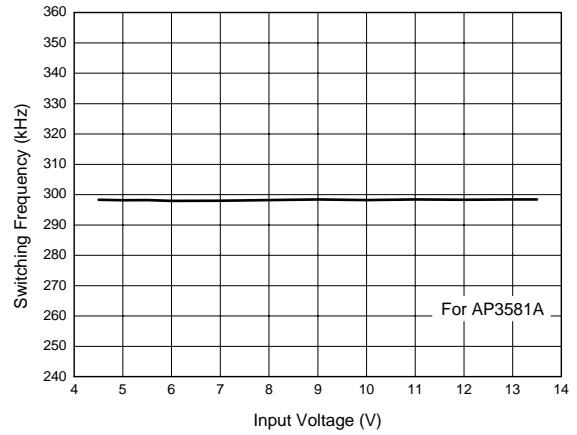

Figure 7. Switching Frequency vs. Input Voltage

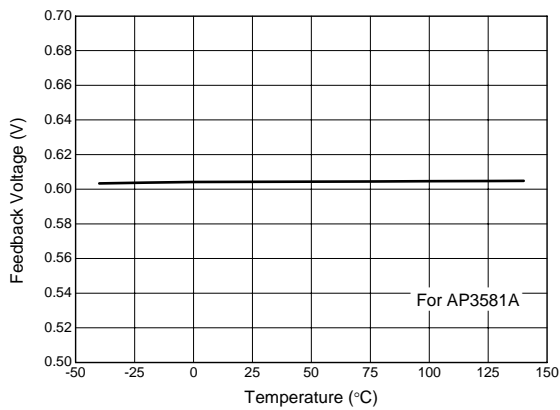

Figure 8. Feedback Voltage vs. Temperature

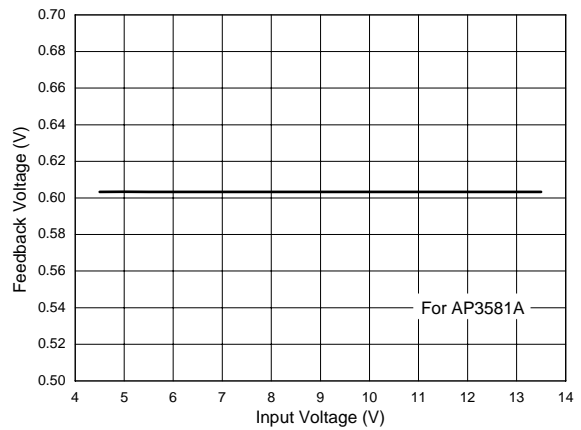
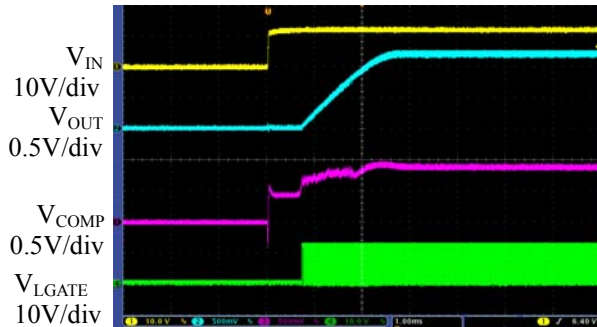

Figure 9. Feedback Voltage vs. Input Voltage

Typical Performance Characteristics (Continued)



Time 1ms/div

Figure 10. Power-on Waveform  
( $V_{IN}=12V$ ,  $V_{OUT}=1.2V$ ,  $I_{OUT}=0A$ )

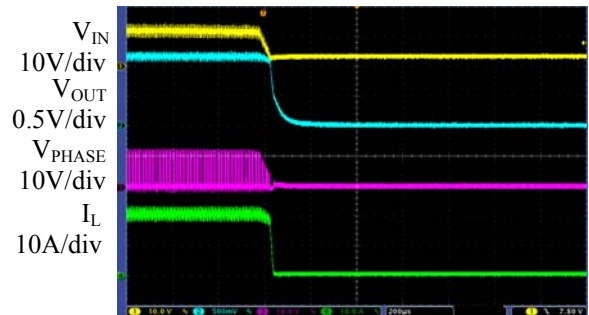

Time 200µs/div

Figure 11. Power-off Waveform  
( $V_{IN}=12V$ ,  $V_{OUT}=1.2V$ ,  $I_{OUT}=20A$ )

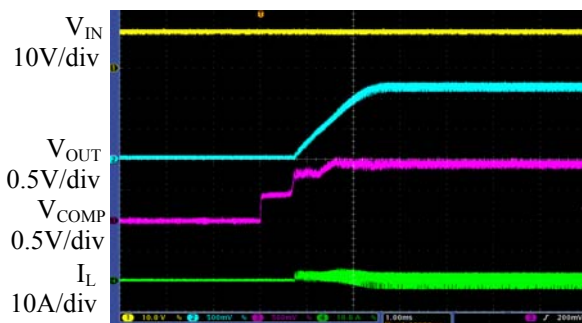

Time 1ms/div

Figure 12. Enable Waveform  
( $V_{IN}=12V$ ,  $V_{OUT}=1.2V$ ,  $I_{OUT}=0A$ )

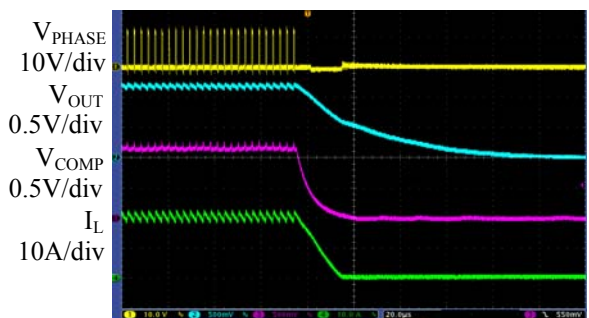

Time 20µs/div

Figure 13. Disable Waveform  
( $V_{IN}=12V$ ,  $V_{OUT}=1.2V$ ,  $I_{OUT}=20A$ )



Single Phase Synchronous Buck PWM Controller

AP3581A/B/C

Typical Performance Characteristics (Continued)

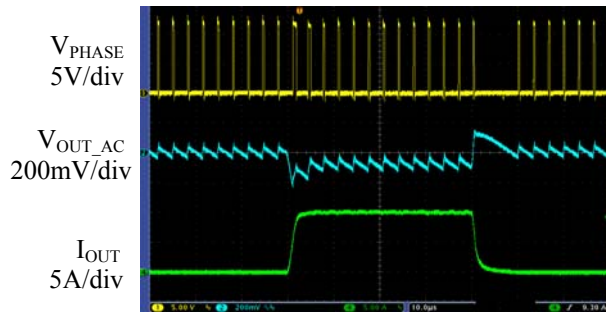

Time 10μs/div

Figure 14. Load Transient Response  
(V<sub>IN</sub>=12V, V<sub>OUT</sub>=1.2V, I<sub>OUT</sub>=0A to 10A)

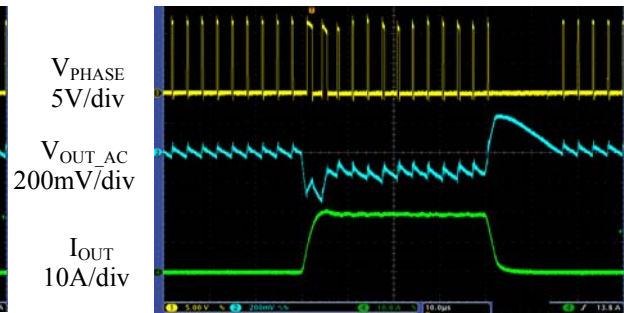

Time 10μs/div

Figure 15. Load Transient Response  
(V<sub>IN</sub>=12V, V<sub>OUT</sub>=1.2V, I<sub>OUT</sub>=0A to 20A)

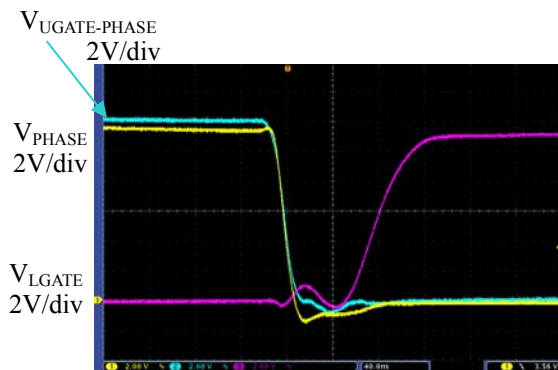

Time 40ns/div

Figure 16. UGATE Turn Off Waveforms  
(V<sub>CC</sub>=V<sub>IN</sub>=12V, V<sub>OUT</sub>=1.2V, I<sub>OUT</sub>=20A)

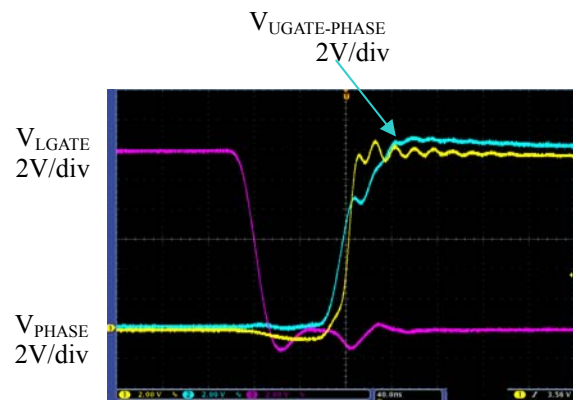

Time 40ns/div

Figure 17. UGATE Turn On Waveforms  
(V<sub>CC</sub>=V<sub>IN</sub>=12V, V<sub>OUT</sub>=1.2V, I<sub>OUT</sub>=20A)

Typical Performance Characteristics (Continued)

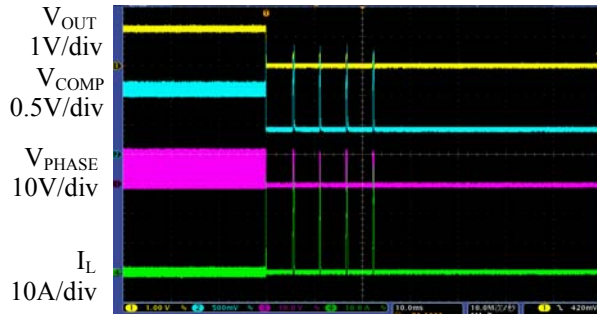

Time 10ms/div

Figure 18. Over Current Protection  
( $V_{IN}=12V$ ,  $V_{OUT}=1.2V$  to  $0V$ ,  $I_{OUT}=0A$ )

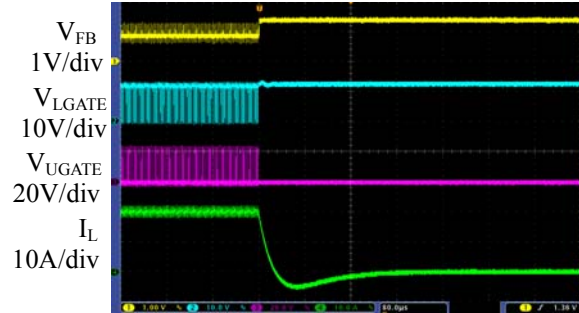

Time 80µs/div

Figure 19. Over Voltage Protection  
( $V_{IN}=12V$ ,  $V_{OUT}=1.2V$ ,  $I_{OUT}=20A$ )

**Single Phase Synchronous Buck PWM Controller**
**AP3581A/B/C**
**Typical Application**

Figure 20. Typical Application Circuit of AP3581A/B/C

**Mechanical Dimensions**

**PSOP-8**

**Unit: mm(inch)**

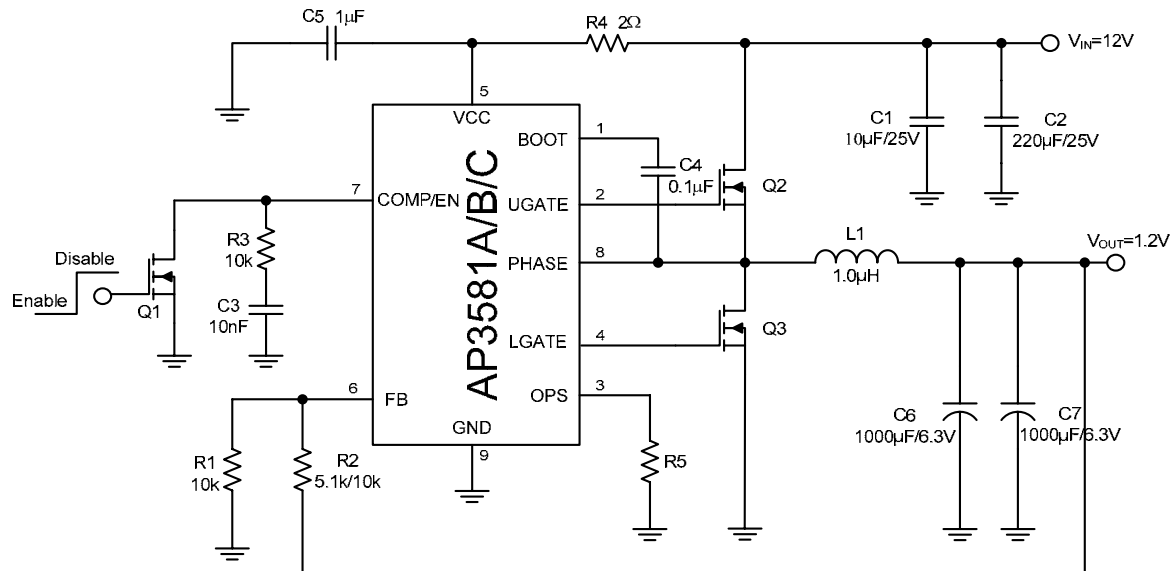
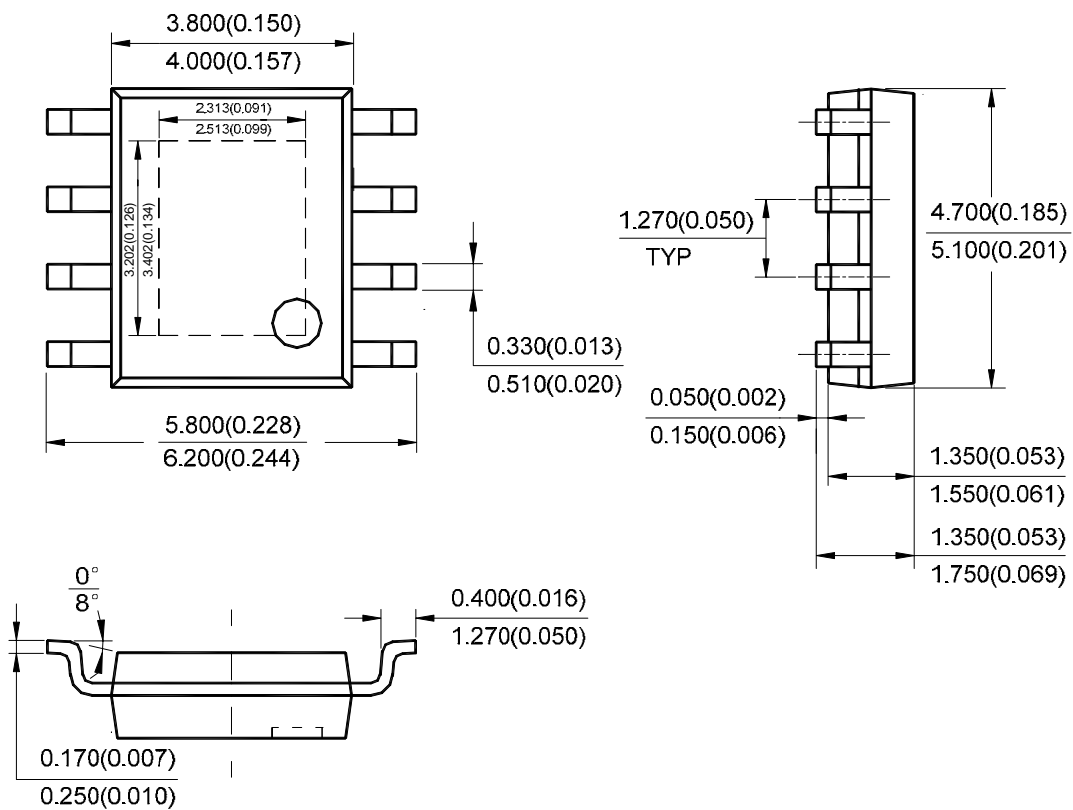

Note: Eject hole, oriented hole and mold mark is optional.



## **BCD Semiconductor Manufacturing Limited**

<http://www.bcdsemi.com>

### **IMPORTANT NOTICE**

BCD Semiconductor Manufacturing Limited reserves the right to make changes without further notice to any products or specifications herein. BCD Semiconductor Manufacturing Limited does not assume any responsibility for use of any its products for any particular purpose, nor does BCD Semiconductor Manufacturing Limited assume any liability arising out of the application or use of any its products or circuits. BCD Semiconductor Manufacturing Limited does not convey any license under its patent rights or other rights nor the rights of others.

---

#### **MAIN SITE**

##### **- Headquarters**

##### **BCD Semiconductor Manufacturing Limited**

No. 1600, Zi Xing Road, Shanghai Zizhu Science-based Industrial Park, 200241, China  
Tel: +86-21-24162266, Fax: +86-21-24162277

##### **- Wafer Fab**

##### **Shanghai SIM-BCD Semiconductor Manufacturing Co., Ltd.**

800 Yi Shan Road, Shanghai 200233, China  
Tel: +86-21-6485 1491, Fax: +86-21-5450 0008

#### **REGIONAL SALES OFFICE**

##### **Shenzhen Office**

##### **Shanghai SIM-BCD Semiconductor Manufacturing Co., Ltd., Shenzhen Office**

Unit A Room 1203, Skyworth Bldg., Gaoxin Ave. 1.S., Nanshan District, Shenzhen, China  
Tel: +86-755-8826 7951  
Fax: +86-755-8826 7865

##### **Taiwan Office**

##### **BCD Semiconductor (Taiwan) Company Limited**

4F, 298-1, Rui Guang Road, Nei-Hu District, Taipei, Taiwan  
Tel: +886-2-2656 2808  
Fax: +886-2-2656 2806

##### **USA Office**

##### **BCD Semiconductor Corp.**

30920 Huntwood Ave. Hayward, CA 94544, USA  
Tel : +1-510-324-2988  
Fax: +1-510-324-2788