

**WHITE LED STEP-UP CONVERTER****AP3036/A****General Description**

The AP3036/A is an inductor-based DC/DC converter designed to drive up to eight white LEDs in series for backlight. Only one feedback resistor is needed to control the LED current and obtain required brightness.

A constant frequency 1.0MHz PWM control scheme is employed in this IC, which means tiny external components can be used. Specifically, 1mm tall inductor and 0.22 $\mu$ F output capacitor for a typical application is sufficient. Additionally, the Schottky diode in boost circuit is integrated on this chip. The AP3036/A also provides a disable pin to ease its use for different systems.

The output over-voltage protection is implemented in AP3036/A. When any LED is broken or in other abnormal conditions, the output voltage will be clamped.

The AP3036/A is available in standard SOT-23-6 and TSOT-23-6 packages.

**Features**

- Inherently Uniform LED Current
- High Efficiency up to 84%
- No Need for External Schottky Diode
- Output Over-voltage Protection (OVP)
- Fixed 1.0MHz Switching Frequency
- Uses Tiny 1mm Tall Inductor
- Requires Only 0.22 $\mu$ F Output Capacitor
- High Frequency Dimming Control

**Applications**

- Cellular Phones
- Digital Cameras
- LCD Modules
- GPS Receivers
- PDAs, Handheld Computers

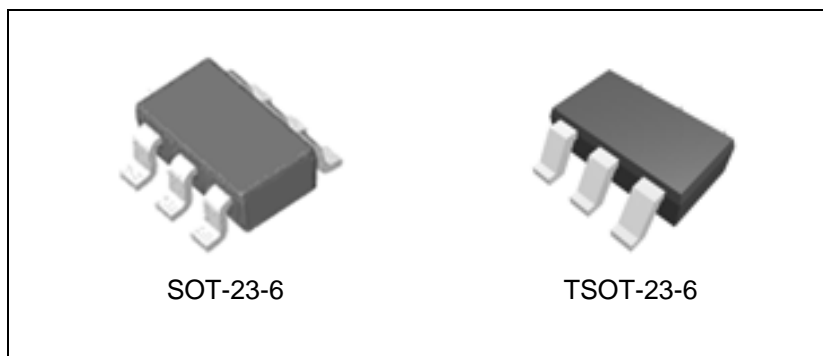

Figure 1. Package Types of AP3036/A

**WHITE LED STEP-UP CONVERTER**
**AP3036/A**
**Pin Configuration**

Figure 2. Pin Configuration of AP3036/A (Top View)

**Pin Description**

Pin Number	Pin Name	Function
1	SW	Switch pin. Connect external inductor
2	GND	Ground
3	FB	Voltage feedback pin. The reference voltage is 200mV for AP3036 and 250mV for AP3036A
4	CTRL	Shutdown and dimming pin. Connect to 1.8V or higher to enable device; Connect to 0.4V or less to disable device; Connect to a PWM signal to achieve LEDs brightness dimming
5	VOUT	Output pin. Connect to the cathode of internal Schottky diode
6	VIN	Input supply pin. Must be connected to a local bypass capacitor

**WHITE LED STEP-UP CONVERTER**

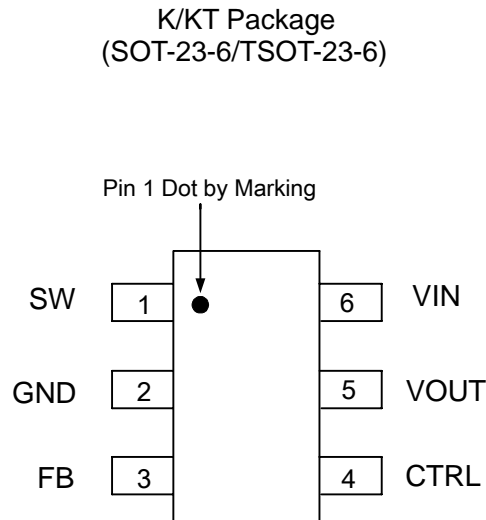
**AP3036/A**

**Functional Block Diagram**

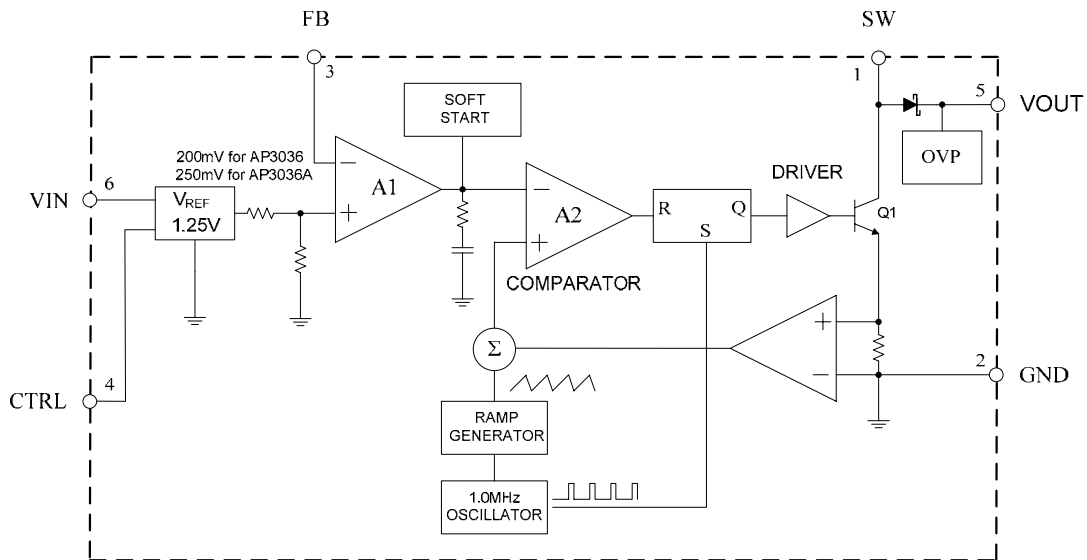
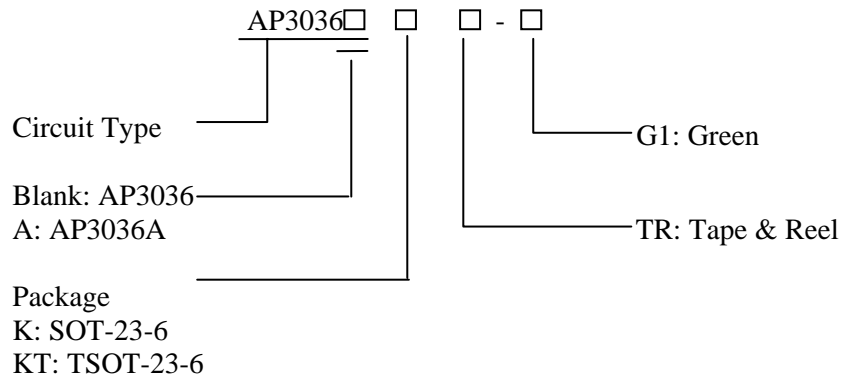

Figure 3. Functional Block Diagram of AP3036/A

**Ordering Information**



Package	Temperature Range	Part Number	Marking ID	Packing Type
SOT-23-6	-40 to 85°C	AP3036KTR-G1	GHI	Tape & Reel
		AP3036AKTR-G1	GJE	Tape & Reel
TSOT-23-6		AP3036KTTR-G1	L2C	Tape & Reel
		AP3036AKTTR-G1	L3C	Tape & Reel

BCD Semiconductor's Pb-free products, as designated with "G1" suffix in the part number, are RoHS compliant and green.

**WHITE LED STEP-UP CONVERTER****AP3036/A****Absolute Maximum Ratings (Note 1)**

Parameter	Symbol	Value	Unit
Input Voltage	$V_{IN}$	20	V
SW Pin Voltage	$V_{SW}$	38	V
Feedback Voltage	$V_{FB}$	20	V
CTRL Pin Voltage	$V_{CTRL}$	20	V
Thermal Resistance (Junction to Ambient, No Heat Sink)	$\theta_{JA}$	265	°C/W
Operating Junction Temperature	$T_J$	150	°C
Storage Temperature Range	$T_{STG}$	-65 to 150	°C
Lead Temperature (Soldering, 10sec)	$T_{LEAD}$	260	°C
ESD (Machine Model)		250	V
ESD (Human Body Model)		2000	V

Note 1: Stresses greater than those listed under “Absolute Maximum Ratings” may cause permanent damage to the device. These are stress ratings only, and functional operation of the device at these or any other conditions beyond those indicated under “Recommended Operating Conditions” is not implied. Exposure to “Absolute Maximum Ratings” for extended periods may affect device reliability.

**Recommended Operating Conditions**

Parameter	Symbol	Min	Max	Unit
Operating Temperature Range	$T_{OP}$	-40	85	°C
Input Voltage	$V_{IN}$	2.5	16	V
CTRL Pin Voltage	$V_{CTRL}$		16	V



**WHITE LED STEP-UP CONVERTER**

**AP3036/A**

**Electrical Characteristics**

$V_{IN}=3V$ ,  $V_{CTRL}=3V$ ,  $T_A=25^{\circ}C$ , unless otherwise specified.

Parameter	Symbol	Conditions	Min	Typ	Max	Unit	
Minimum Operating Voltage	$V_{IN}$ (Min)		2.5			V	
Maximum Operating Voltage	$V_{IN}$ (Max)				16		
Feedback Voltage	$V_{FB}$	AP3036	$I_{OUT}=20mA$ , 4 LEDs	188	200	212	mV
		AP3036A		235	250	265	
FB Pin Bias Current	$I_{FB}$			35	100	nA	
Quiescent Current	$I_Q$	$V_{FB}=V_{IN}$ , Switching No	1.6	3.1	3.9	mA	
Shutdown Quiescent Current	$I_{SHDN}$	$V_{CTRL}=0V$		45	75	$\mu A$	
Switching Frequency	f			1.0		MHz	
Maximum Duty Cycle	$D_{MAX}$		90	93		%	
Switch Current Limit (Note 2)	$I_{LIMIT}$	D=40% or 80%		550		mA	
Switch $V_{CE}$ Saturation Voltage	$V_{CESAT}$	$I_{SW}=250mA$		360		mV	
Switch Leakage Current		$V_{SW}=5V$		0.01	5	$\mu A$	
CTRL Pin Voltage	$V_{CTRL}$	High	1.8			V	
		Low			0.4		
CTRL Pin Bias Current	$I_{CTRL}$			100		$\mu A$	
OVP Voltage	$V_{OV}$			30		V	
Schottky Forward Drop	$V_{DROP}$	$I_D=150mA$		0.7		V	
Schottky Leakage Current		$V_R$ (Reverse Voltage)=23V		0.1	4	$\mu A$	
		$V_R$ (Reverse Voltage)=27V			150		
Soft Start Time	t			100		$\mu s$	
Thermal Resistance (Junction to Case)	$\theta_{JC}$	SOT-23-6		60		$^{\circ}C/W$	
		TSOT-23-6		60			

Note 2: The switch current limit is related to duty cycle. Please refer to Figure 16 for detail.



**WHITE LED STEP-UP CONVERTER**

**AP3036/A**

**Typical Performance Characteristics**

The WLED forward voltage ( $V_F$ ) is 3.45V at  $I_F=20mA$ , unless otherwise noted.

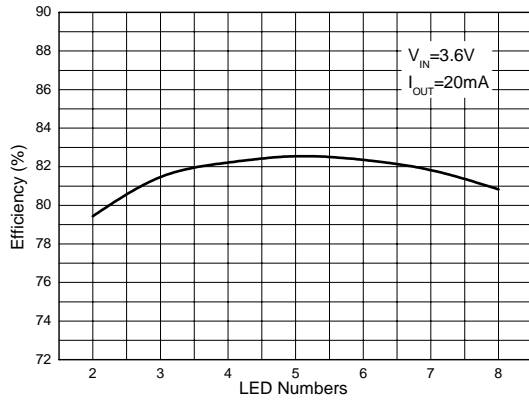

Figure 4. Efficiency vs. LED's Number

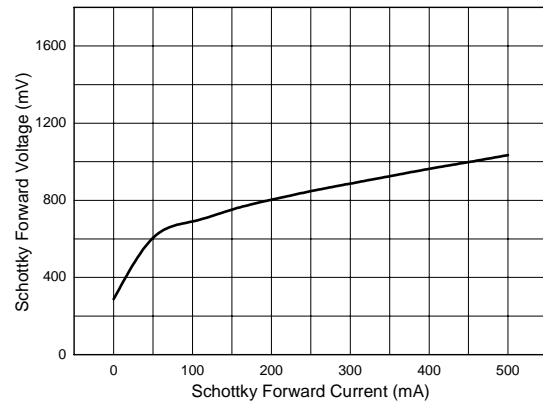

Figure 5. Schottky Forward Voltage vs. Schottky Forward Current

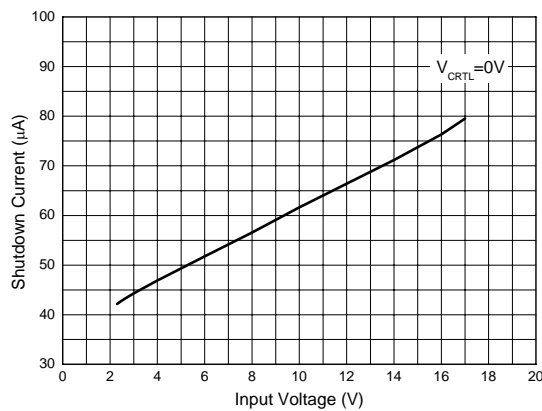

Figure 6. Shutdown Current vs. Input Voltage

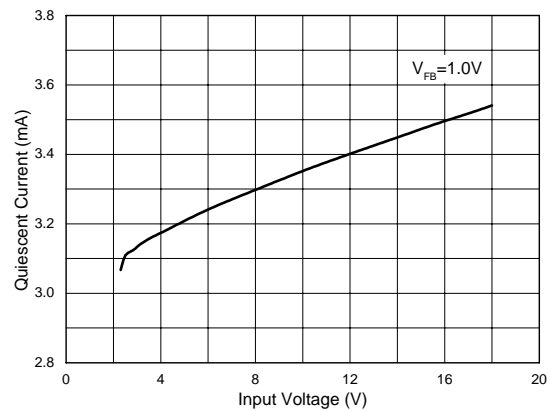

Figure 7. Quiescent Current vs. Input Voltage



**WHITE LED STEP-UP CONVERTER**

**AP3036/A**

**Typical Performance Characteristics (Continued)**

The WLED forward voltage ( $V_F$ ) is 3.45V at  $I_F=20\text{mA}$ , unless otherwise noted.

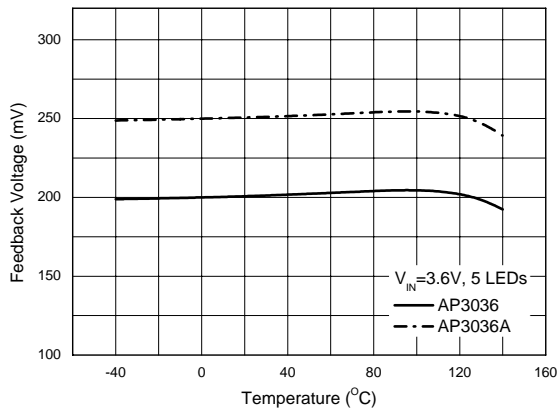

Figure 8. Feedback Voltage vs. Temperature

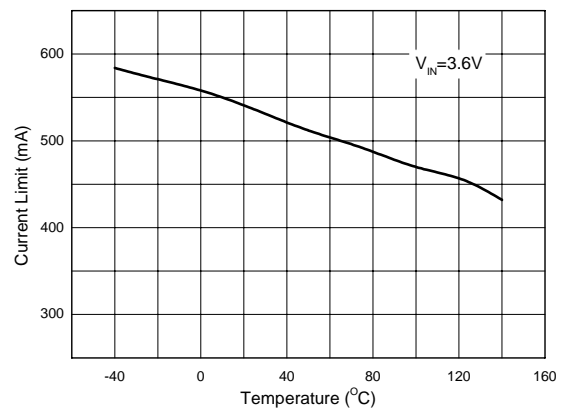

Figure 9. Current Limit vs. Temperature

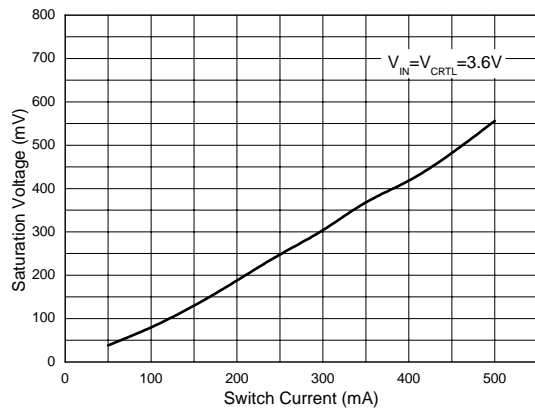

Figure 10. Saturation Voltage vs. Switch Current

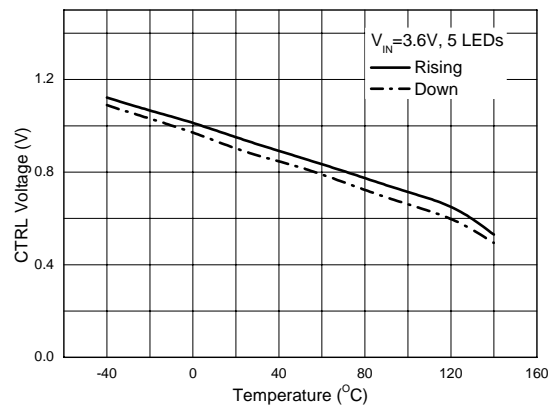

Figure 11. CTRL Pin Voltage vs. Temperature



**WHITE LED STEP-UP CONVERTER**

**AP3036/A**

**Typical Performance Characteristics (Continued)**

The WLED forward voltage ( $V_F$ ) is 3.45V at  $I_F=20\text{mA}$ , unless otherwise noted.

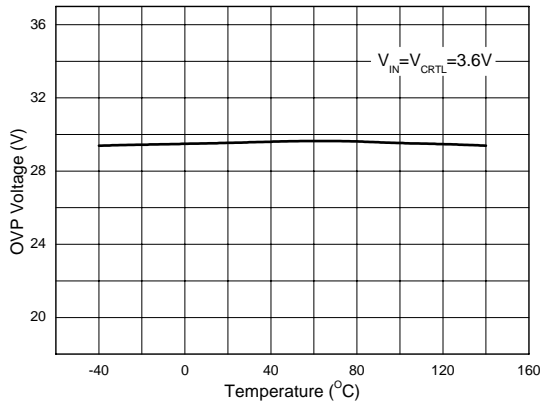

Figure 12. OVP Voltage vs. Temperature

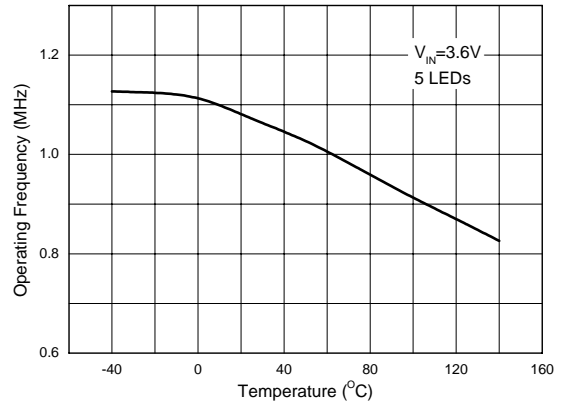

Figure 13. Operating Frequency vs. Temperature

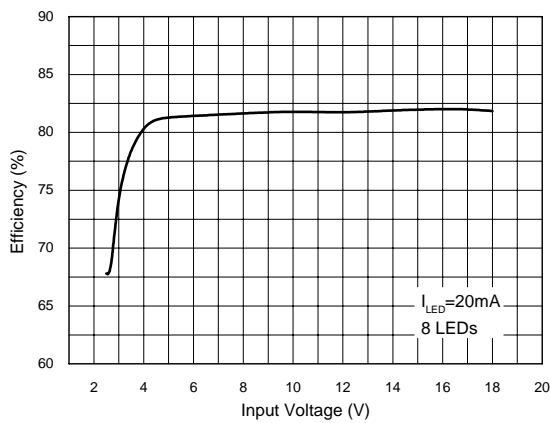

Figure 14. Efficiency vs. Input Voltage

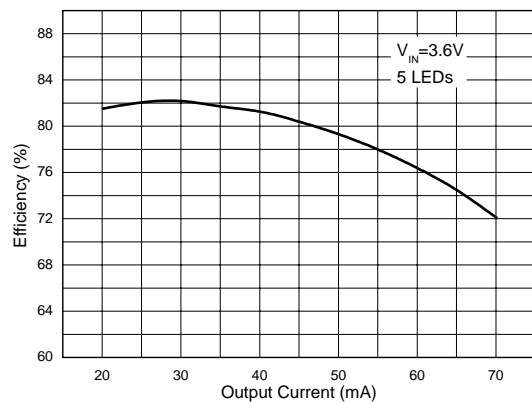

Figure 15. Efficiency vs. Output Current



**WHITE LED STEP-UP CONVERTER**

**AP3036/A**

**Typical Performance Characteristics (Continued)**

The WLED forward voltage ( $V_F$ ) is 3.45V at  $I_F=20\text{mA}$ , unless otherwise noted.

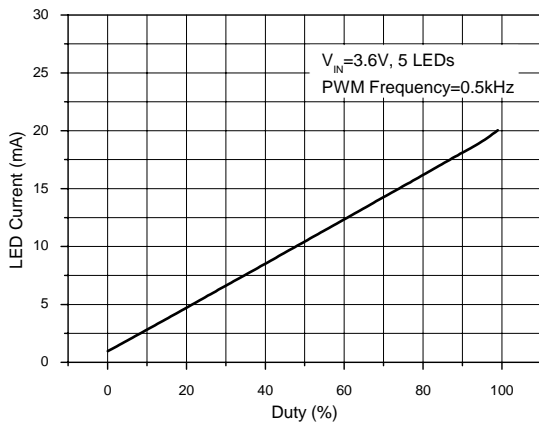

Figure 16. LED Current vs. Duty

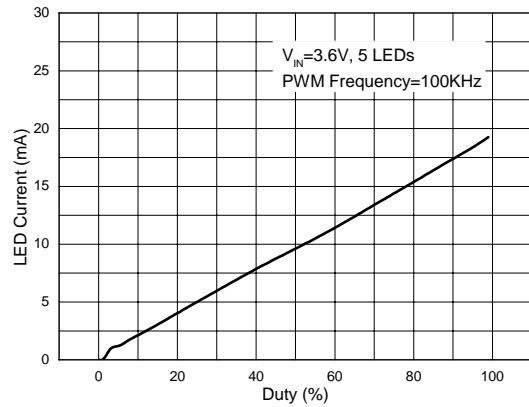
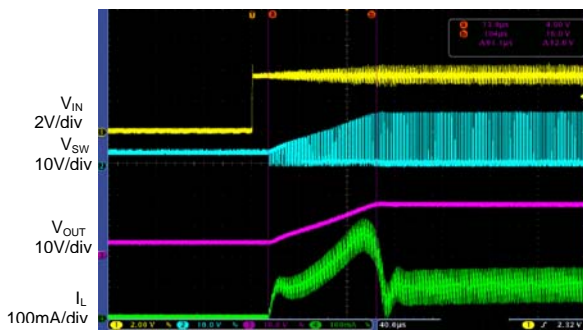
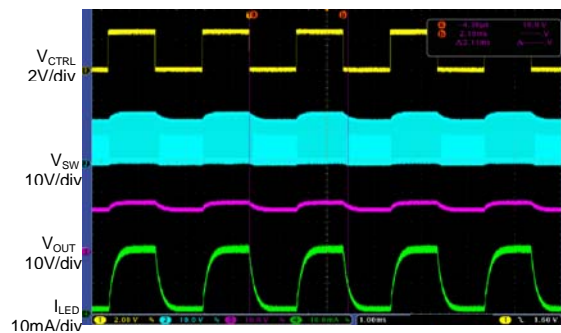

Figure 17. LED Current vs. Duty



Time 40µs/div

Figure 18. Powering On  
( $V_{IN}=3.6\text{V}$ ,  $V_{CTRL}=2.5\text{V}$ ,  $I_{LED}=20\text{mA}$ , 5 LEDs)



Time 10ms/div

Figure 19. PWM Dimming  
( $V_{IN}=3.6\text{V}$ ,  $V_{PWM}=2.5\text{V}$ ,  $f_{PWM}=0.5\text{kHz}$ , Duty=50%, 5 LEDs)

**WHITE LED STEP-UP CONVERTER**

**AP3036/A**

**Typical Performance Characteristics (Continued)**

The WLED forward voltage ( $V_F$ ) is 3.45V at  $I_F=20\text{mA}$ , unless otherwise noted.

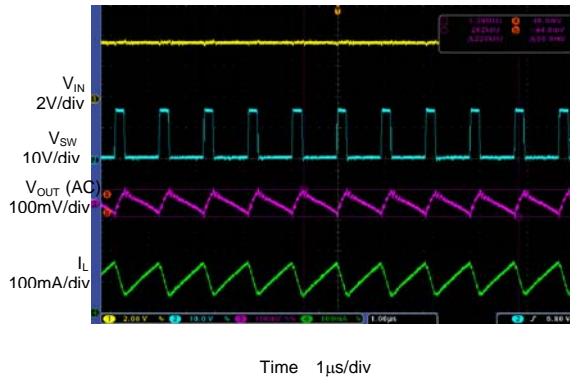

Figure 20. Output Voltage Ripple  
( $V_{IN}=V_{CTRL}=3.6\text{V}$ ,  $I_{LED}=20\text{mA}$ , 5 LEDs)

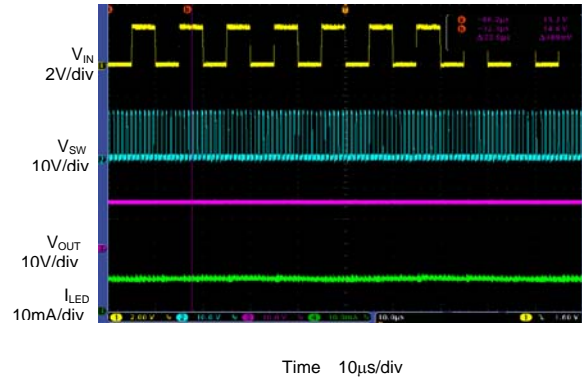

Figure 21. PWM Dimming  
( $V_{IN}=3.6\text{V}$ ,  $V_{PWM}=2.5\text{V}$ ,  $f_{PWM}=100\text{kHz}$ , Duty=50%, 5 LEDs)

**Typical Application**

Figure 22. Typical Application of AP3036/A (Note 3)

Note 3: C: X5R or X7R type dielectric, L: SUMIDA CDRH5D28R-220NC or equivalent. And, this circuit can work in full temperature.

**WHITE LED STEP-UP CONVERTER**

**AP3036/A**

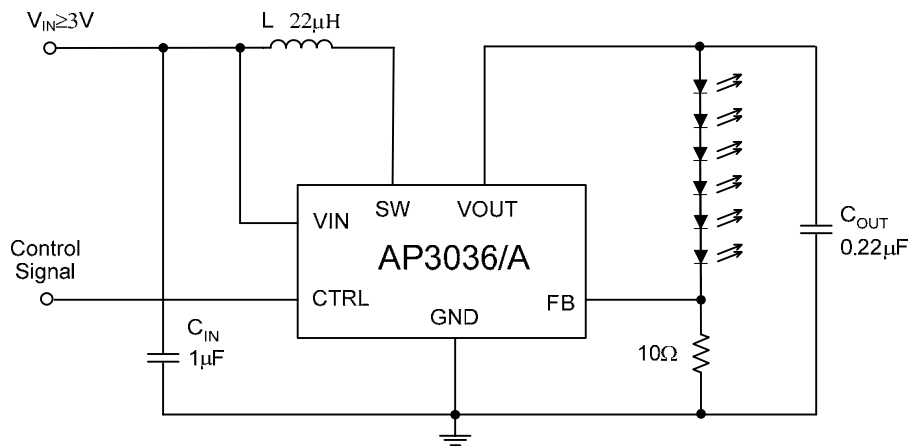
**Mechanical Dimensions**

**SOT-23-6**

**Unit: mm(inch)**

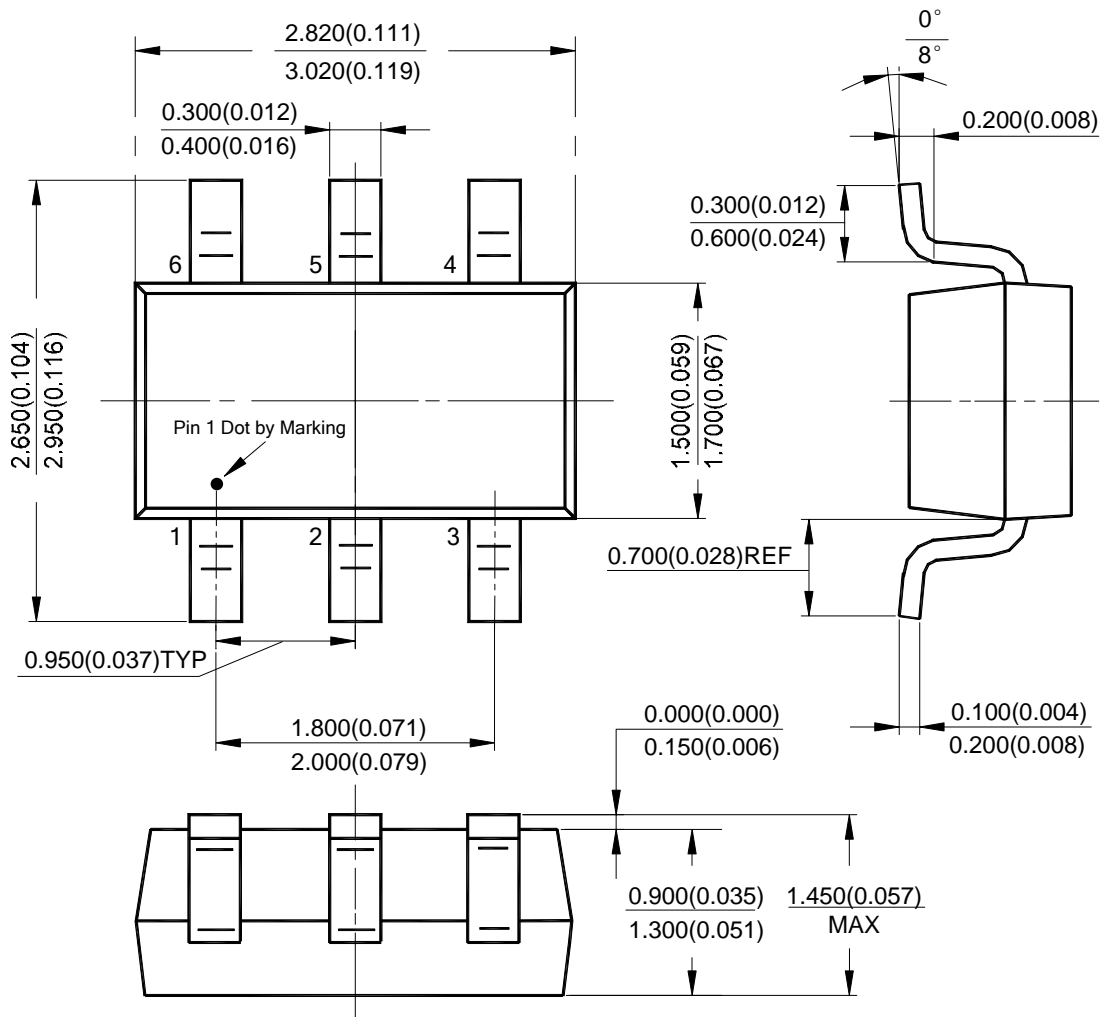

**WHITE LED STEP-UP CONVERTER**

**AP3036/A**

**Mechanical Dimensions (Continued)**

**TSOT-23-6**

**Unit: mm(inch)**

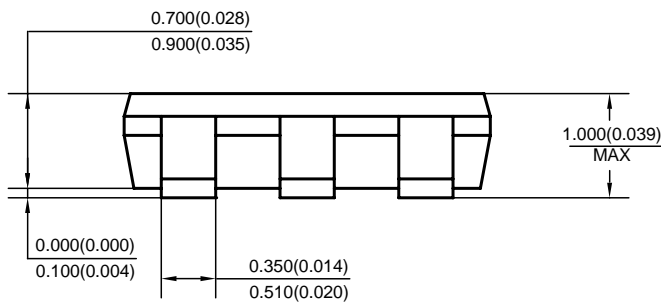
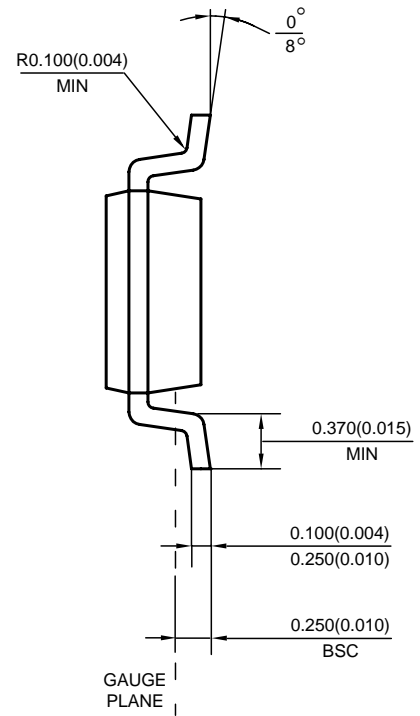
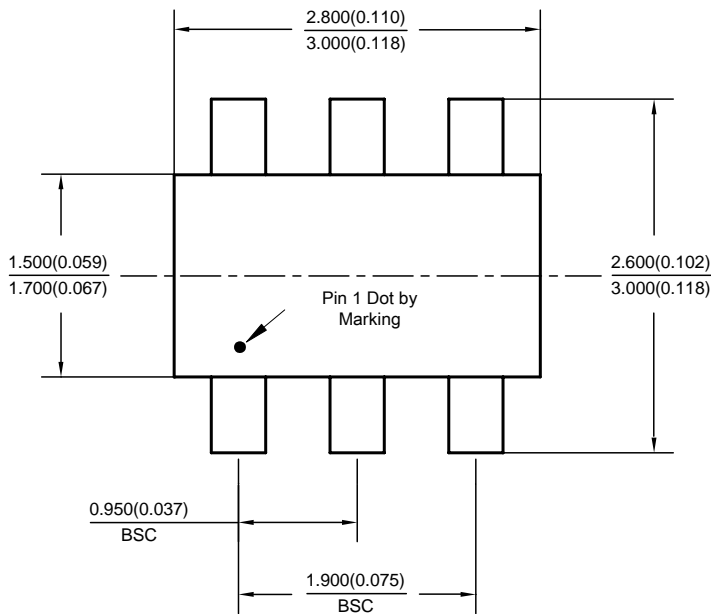



## BCD Semiconductor Manufacturing Limited

<http://www.bcdsemi.com>

### IMPORTANT NOTICE

BCD Semiconductor Manufacturing Limited reserves the right to make changes without further notice to any products or specifications herein. BCD Semiconductor Manufacturing Limited does not assume any responsibility for use of any its products for any particular purpose, nor does BCD Semiconductor Manufacturing Limited assume any liability arising out of the application or use of any its products or circuits. BCD Semiconductor Manufacturing Limited does not convey any license under its patent rights or other rights nor the rights of others.

---

#### MAIN SITE

##### - Headquarters

##### BCD Semiconductor Manufacturing Limited

No. 1600, Zi Xing Road, Shanghai ZiZhu Science-based Industrial Park, 200241, China  
Tel: +86-21-24162266, Fax: +86-21-24162277

##### - Wafer Fab

##### Shanghai SIM-BCD Semiconductor Manufacturing Co., Ltd.

800 Yi Shan Road, Shanghai 200233, China  
Tel: +86-21-6485 1491, Fax: +86-21-5450 0008

#### REGIONAL SALES OFFICE

##### Shenzhen Office

##### Shanghai SIM-BCD Semiconductor Manufacturing Co., Ltd., Shenzhen Office

Unit A Room 1203, Skyworth Bldg., Gaoxin Ave. 1.S., Nanshan District, Shenzhen, China  
Tel: +86-755-8826 7951  
Fax: +86-755-8826 7865

##### Taiwan Office

##### BCD Semiconductor (Taiwan) Company Limited

4F, 298-1, Rui Guang Road, Nei-Hu District, Taipei, Taiwan  
Tel: +886-2-2656 2808  
Fax: +886-2-2656 2806

##### USA Office

##### BCD Semiconductor Corp.

30920 Huntwood Ave. Hayward, CA 94544, USA  
Tel : +1-510-324-2988  
Fax: +1-510-324-2788