

PROPRIETARY INFORMATION: PROPRIETARY OF GLOBTEK, INC. ANY REPRODUCTION, DISCLOSURE OR USE OF THIS DRAWING, IN WHOLE OR IN PART, IS HEREBY PROHIBITED EXCEPT AS SPECIFIED IN WRITING BY GLOBTEK, INC.	REVISION			
	REV	DESCRIPTION	DATE	APPROVED
	A	INITIAL RELEASE, RFS. 5145, SP	12/10/04	DMR



PRELIMINARY

1. NOTES:

DIMENSIONS ARE IN MM UNLESS SPECIFIED OTHERWISE.

2. ELECTRICAL SPECIFICATIONS:

INPUT VOLTAGE:	100-240 VAC
INPUT CURRENT:	<TBAA RMS MAX
INPUT FREQUENCY:	47 - 63 HZ
OUTPUT VOLTAGE / CURRENT:	5 VDC @ 3.0 A
OUTPUT CURRENT :	NO LOAD TO FULL LOAD, NO MINIMUM LOAD REQUIRED
OUTPUT POWER (RATED):	15 WATTS MAX
SWITCHING FREQUENCY	
OUTPUT RIPPLE (PEAK TO PEAK):	1% TYPICAL
OUTPUT REGULATION (LINE/LOAD):	± 5 % FOR MAIN OUTPUT, MEASURED AT O/P CONNECTOR
LINE REGULATION:	± 1 % MAX AT FULL LOAD
TURN ON/ TURN OFF OVERSHOOT:	4% MAX 500uS MAX RECOVERY TIME FOR 25% STEP LOAD
TURN-ON DELAY:	3000 mSEC MAX
HOLD-UP TIME:	16 mSEC MIN AT NOMINAL INPUT AND FULL LOAD
INRUSH CURRENT:	30 A MAX AT COLD START 120 VAC, 60A MAX COLD START 230VAC
SWITCHING FREQUENCY:	TBAKHz TYPICAL
OVER-VOLTAGE PROTECTION:	VOLTAGE LIMITED LESS 130% OF NOMINAL VOLTAGE
OVER-CURRENT / SHORT CIRCUIT:	HICCUP WITH AUTO RECOVERY TO 1.1 - 1.3 I _o
OTHER PROTECTION:	INPUT FUSING
NO LOAD POWER CONSUMPTION:	< 2W @ 230V
SAFETY APPROVALS (PENDING):	UL60950-1, CUL TO 22.2# 950, DEMKO TO EN60950, CCC TO GB4943-2001, GB9254-1998, GB17625.1-2003, CE CLASS II, AS/NZ 60950, PSE TO J60950, CB REPORT
DIELECTRIC WITHSTAND VOLTAGE:	3000 VAC or 4242VDC 10 mA 1 MINUTE
LEAKAGE CURRENT:	≤ 0.25 mA
LINE SURGE:	EN 61000-4-5 LEVEL 4
EMI:	COMPLIES WITH EN55022 CLASS B AND FCC PART 15 CLASS B WHEN TESTED WITH A RESISTIVE LOAD, BOTH CONDUCTED AND RADIATED
CE MARK:	TESTED TO COMPLY WITH EN61000-3-2 EN61000-3-3AND EN50082-1, INCLUDING EN61000-4-2, EN61000-4-3, EN61000-4-4, EN61000-4-5, EN61000-4-6, EN61000-4-11, LEVEL 4. UNIT IS ELIGIBLE FOR CE MARK.
C-TICK (PENDING):	TESTED TO COMPLY W/RADIO TELECOMMUNICATION ACT OF 1992.
MTBF:	GREATER THAN 50,000 HOURS AT 25°C AMBIENT TEMPERATURE,
OPERATING TEMPERATURE:	0°C TO 40° C
STORAGE TEMPERATURE:	-40°C TO 80° C

Foot Note: Globtek Inc. will not be liable for the safety and performance of these power supplies if unauthorized access and repair occurs. End user should consult applicable UL, CSA or EN standards for proper installation instructions	DASH NO.	PART NO	REV.	DESCRIPTION	NOTES	
	TABULATION BLOCK					
Limitation of Use: Globtek product are not authorized for use as mission critical components in life support, hazardous environment, nuclear or aircraft applications without prior written approval from the CEO of Globtek Inc.	INIT.BY: SP		DATE: 12/10/04	TOLERANCES: DECIMALS ANGULAR .xx +/- 0.1 +/- 1° .xxx +/- .005 MILLIMETERS ANGULAR .xx +/- 0.3 +/- 1° .xxx +/- .013	GlobTek, Inc. 186 Veterans Dr. Northvale, NJ 07647 Tel. 201-784-1000 Fax 201.784.0111 www.globtek.com	
	DRAWN: NF	DATE: 12/10/04	FSCN No.: G, N			SIZE A
Contents of this document are subject to change without prior notice	APRVD :DMR	DATE: 12/10/04	CAGE CODE: 0GV V90	SCALE: NONE	MODEL NO: GT-41060-1505	REV. A
	PART NO: WR9QA3000LLP-N				SHEET 1 OF 4	

PROPRIETARY INFORMATION:

PROPRIETARY OF GLOBTEK, INC. ANY REPRODUCTION, DISCLOSURE OR USE OF THIS DRAWING, IN WHOLE OR IN PART, IS HEREBY PROHIBITED EXCEPT AS SPECIFIED IN WRITING BY GLOBTEK, INC.

3. ENCLOSURE

UPPER HOUSING: HIGH IMPACT PLASTIC, 94V0 POLYCARBONATE, NON-VENTED, COLOR BLACK

LOWER HOUSING: HIGH IMPACT PLASTIC 94V0 POLYCARBONATE, NON- VENTED, COLOR BLACK

SIZE: 74 x 43.5 x 34 mm

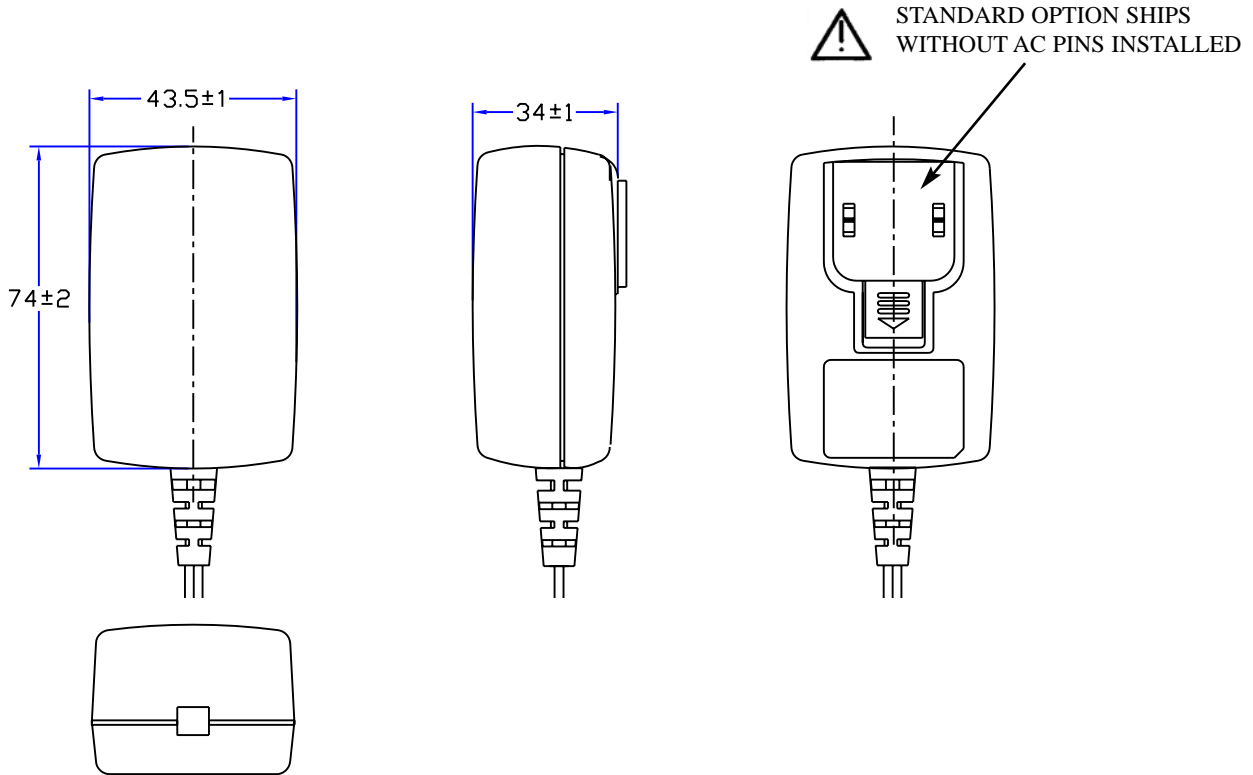

4. INPUT CONNECTOR:

N.A. CONFIGURATION:

1. CLASS II MODEL NEMA 1-15P AC POWER RECEPTACLE WITH 2 PRONGS
2. AUSTRALIAN CONFIGURATION: SAA 2 PINS CLASS II
3. UK CONFIGURATION: UK 2 PINS CLASS II
4. EUROPEAN CONFIGURATION: EUROPLUG 2 PINS, CLASS II

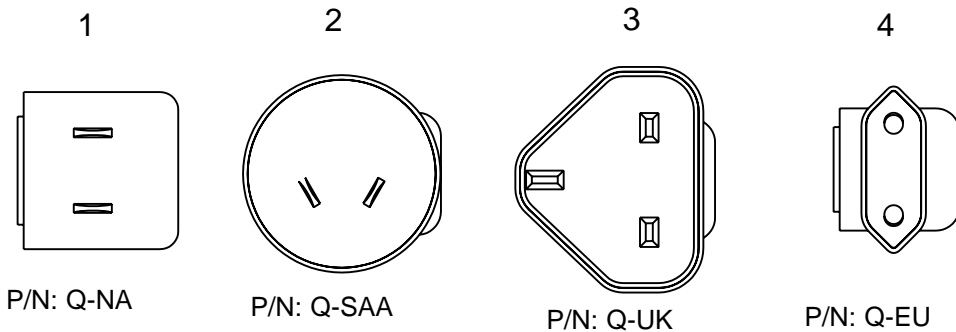

P/N: Q-NA

P/N: Q-SAA

P/N: Q-UK

P/N: Q-EU



STANDARD OPTION, PINS TO BE ORDERED SEPARATELY

KIT INCLUDING:
Q-NA, Q-SAA, Q-UK, Q-EU,
1 PIECE EACH: Q-KIT

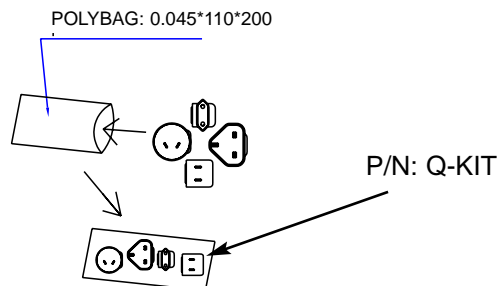

GlobTek, Inc. 186 Veterans Dr. Northvale, NJ 07647 www.globtek.com Tel. 201-784-1000 Fax 201.784.0111	
DWG TITLE: WALL PLUG-IN SWITCHING P3WER SUPPLY, 15 WATTS, UNIVERSAL INPUT, 5V@ 3A	
MODEL NO: GT-41060-1505	REV. A
PART NO: WR9QA3000LLP-N	SHEET 2 OF 4

PROPRIETARY INFORMATION:

PROPRIETARY OF GLOBTEK, INC. ANY REPRODUCTION, DISCLOSURE OR USE OF THIS DRAWING, IN WHOLE OR IN PART, IS HEREBY PROHIBITED EXCEPT AS SPECIFIED IN WRITING BY GLOBTEK, INC.

5. OUTPUT CORD:

1 CONDUCTOR + SHIELD, 18 AWG STRANDED WIRE, ROUND # 1185, COLOR BLACK, LENGTH (L) OF CORD: 1830 +100, -0 mm. CORD IS MEASURED FROM THE HOUSING TO THE END OF OVERMOLD OF THE CONNECTOR. CABLE IS TO BE MARKED WITH WIRE GAUGE, AND ALL APPLICABLE RATING AND SAFETY APPROVALS.

6. OUTPUT CONNECTOR:

LOCKING, STRAIGHT FEMALE BARREL 5.5 x 2.5 x 13.8 mm WITH CENTER POSITIVE:

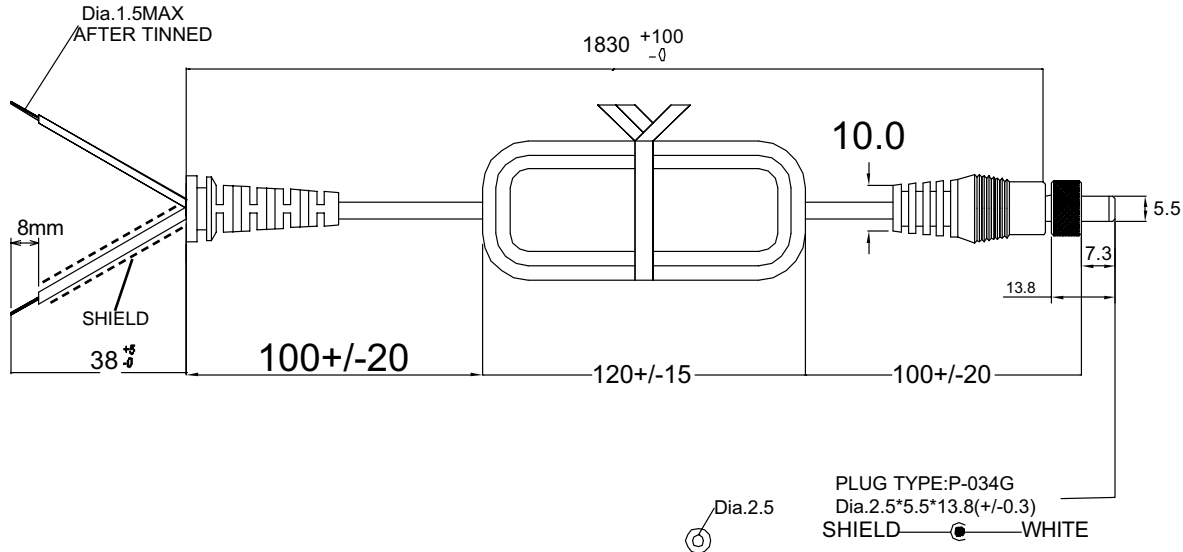

7. LABEL:

MATERIAL: .007 (0.18) THICK FLAT THERMAL TRANSFER, IMPRINTABLE, BLACK POLYESTER SHEET WITH WHITE OR SILVER NOMENCLATURE. MANUFACTURER: STEVEN LABEL, MATERIAL I.D. NO.3302-33, UL FILE NO. MH12821(N), UL MATERIAL DESIGNATION FILE NO. GHW332RL. OPTIONAL LABEL MATERIAL CAN BE SUBSTITUTED PROVIDING MATERIAL IS UL LISTED AND COMPLIES WITH APPLICABLE SAFETY

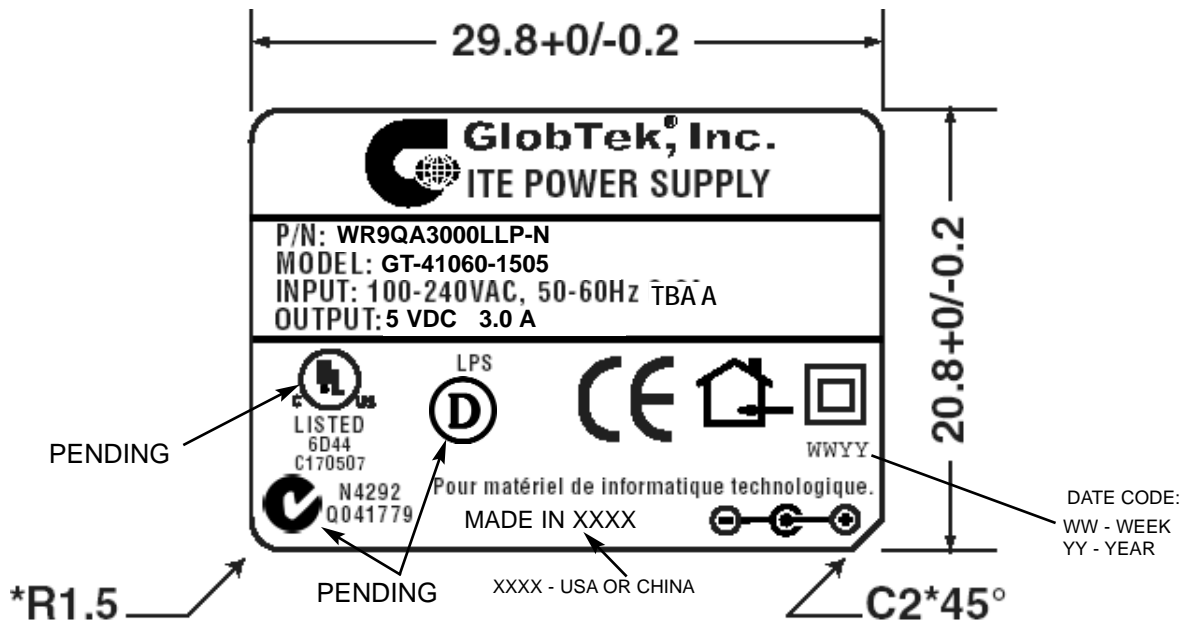

GlobTek, Inc. www.globtek.com		186 Veterans Dr. Northvale, NJ 07647 Tel. 201-784-1000 Fax 201.784.0111
DWG TITLE: WALL PLUG-IN SWITCHING P3WER SUPPLY, 15 WATTS, UNIVERSAL INPUT, 5V@ 3A		
MODEL NO: GT-41060-1505	REV. A	
PART NO: WR9QA3000LLP-N	SHEET 3 OF 4	

PROPRIETARY INFORMATION:
 PROPRIETARY OF GLOBTEK, INC. ANY REPRODUCTION, DISCLOSURE OR
 USE OF THIS DRAWING, IN WHOLE OR IN PART, IS HEREBY
 PROHIBITED EXCEPT AS SPECIFIED IN WRITING BY GLOBTEK, INC.

8. PACKING:

CARTON SIZE: 450 x 295 x 288 mm
 Q'TY: 80 PCS (20*4)

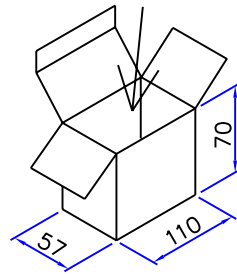
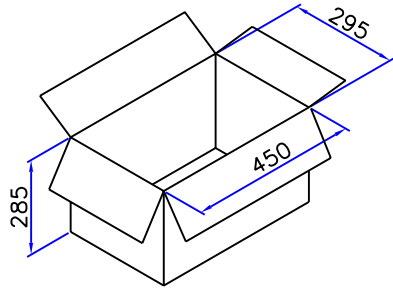

— WHITE BOX: 06

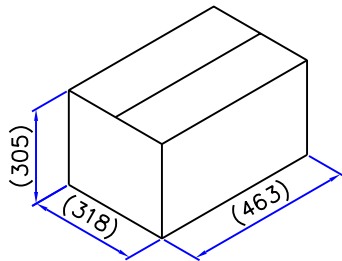

		186 Veterans Dr. Northvale, NJ 07647 Tel. 201-784-1000 Fax 201.784.0111	
www.globtek.com			
DWG TITLE: WALL PLUG-IN SWITCHING P3WER SUPPLY, 15 WATTS, UNIVERSAL INPUT, 5V@ 3A			
MODEL NO: GT-41060-1505			REV. A
PART NO: WR9QA3000LLP-N			SHEET 4 OF 4