

# Dialight Lumidrives

## LUMILEDS™ LUXEON® K2



### FEATURES / BENEFITS

- ▲ For LUXEON K2 LEDs
- ▲ Available in spot, medium, wide and oval lenses
- ▲ Snap-in optics
- ▲ Greater than 85% efficiency

### OPERATING CONDITIONS

- ▲ 105° C max temperature

### MATERIALS/FINISH

- ▲ Lenses are optical grade PMMA acrylic
- ▲ Holders are made of durable polycarbonate

### MECHANICAL DIMENSIONS

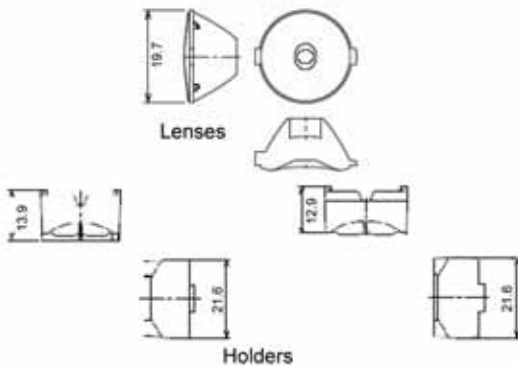

### ORDERING INFORMATION

HOLDERS			
Dialight P/N	Reference P/N	Description	
OHK2BK	OH-K2-BK	LUXEON K2 LEDs - Black	
OHK2CL	OH-K2-CL	LUXEON K2 LEDs - Clear	
OHK2WH	OH-K2-WH	LUXEON K2 LEDs - White	
LENS			
Dialight P/N	Reference P/N	Description	Degree*
OP005	OP-005	Spot Lens	5°
OP015	OP-015	Medium Lens	15°
OP025	OP-025	Wide Lens	25°
OP520	OP-520	Oval Lens	5° X 20°
*All angles refer to half divergence			

Dialight reserves the right to make changes at any time in order to supply the best product possible.

**Dialight Corporation**  
1501 Route 34 South • Farmingdale, NJ 07727 USA  
Tel: (1) 732-919-3119 • Fax: (1) 732-751-5778 • www.dialight.com



MDEXLUMK2\_B

**PHOTOMETRIC DATA**

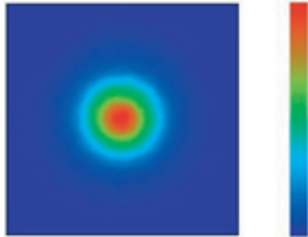

Spot Lens

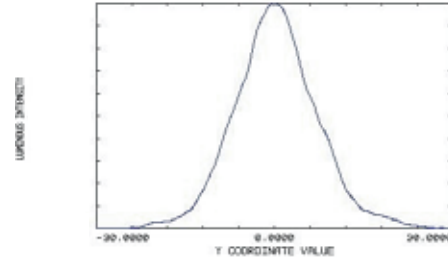

Typical half-angle divergence 5°

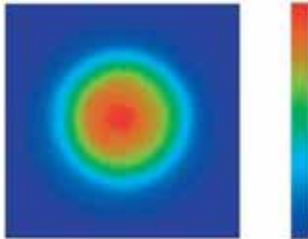

Medium Lens

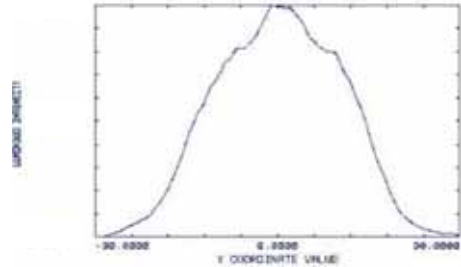

Typical half-angle divergence 15°

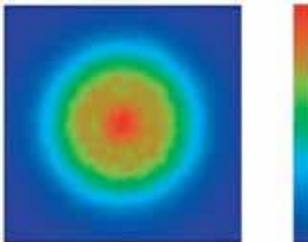

Wide Lens

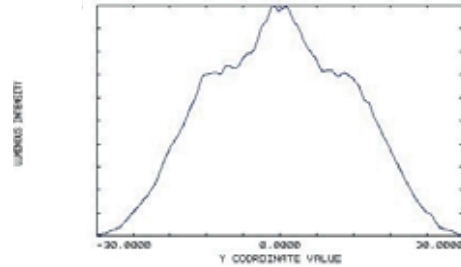

Typical half-angle divergence 25°

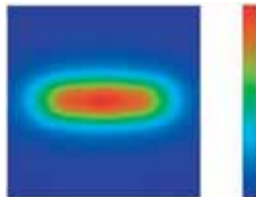

Oval Lens

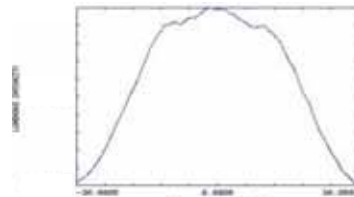

Horizontal

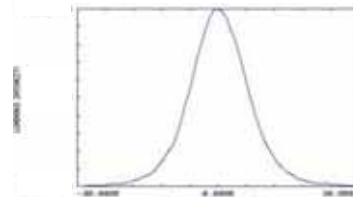

Vertical

Typ. half-angle divergence  
5° X 20°

Dialight reserves the right to make changes at any time in order to supply the best product possible.

**Dialight Corporation**  
1501 Route 34 South • Farmingdale, NJ 07727 USA  
Tel: (1) 732-919-3119 • Fax: (1) 732-751-5778 • www.dialight.com

