



LUMILEDS LUXEON® 20mm LENSES AND HOLDERS



OPERATING CONDITIONS

- ▲ 105°C max temperature

MATERIALS/FINISH

- ▲ Lenses are optical grade PMMA acrylic
- ▲ Holders are made of durable polycarbonate

MECHANICAL DIMENSIONS

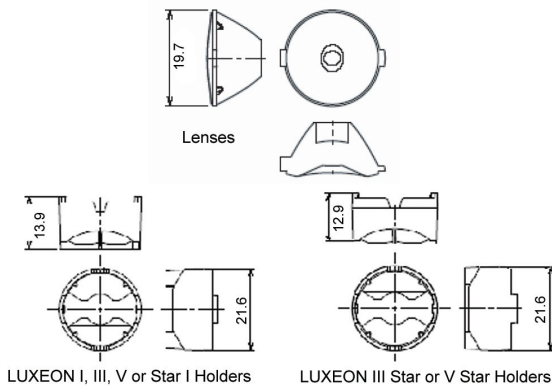

FEATURES / BENEFITS

- ▲ For LUXEON I, III and V emitters & Stars
- ▲ Available in spot, medium, wide and oval lenses
- ▲ Snap-in optics
- ▲ Greater than 85% efficiency

ORDERING INFORMATION

HOLDERS			
Dialight P/N	Reference P/N	Description	
OHES1WH	OH-ES1-WH	LUXEON I, III, V & Star I - Direct PCB Mount (White)	
OHES1BK	OH-ES1-BK	LUXEON I, III, V & Star I - Direct PCB Mount (Black)	
OHES1CL	OH-ES1-CL	LUXEON I, III, V & Star I - Direct PCB Mount (Clear)	
OHS35WH	OH-S35-WH	For Drop-Through Mount & LUXEON Star III & V (White)	
OHS35BK	OH-S35-BK	For Drop-Through Mount & LUXEON Star III & V (Black)	
OHS35CL	OH-S35-CL	For Drop-Through Mount & LUXEON Star III & V (Clear)	
LENS			
Dialight P/N	Reference P/N	Description	Degree*
OP005	OP-005	Spot Lens	5°
OP015	OP-015	Medium Lens	15°
OP025	OP-025	Wide Lens	25°
OP520	OP-520	Oval Lens	5° X 20°
*All angles refer to half divergence			

Dialight reserves the right to make changes at any time in order to supply the best product possible.

Dialight Corporation
 1501 Route 34 South • Farmingdale, NJ 07727 USA
 Tel: (1) 732-919-3119 • Fax: (1) 732-751-5778 • www.dialight.com



MDEXLUMLUX_B

PHOTOMETRIC DATA

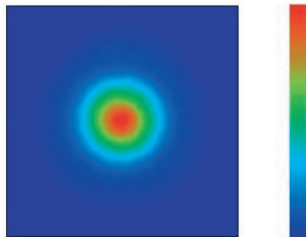

Spot Lens

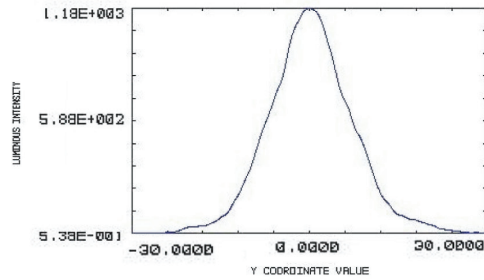

Typical half-angle divergence 5°
when using LUXEON I Cool White

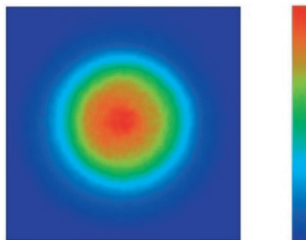

Medium Lens

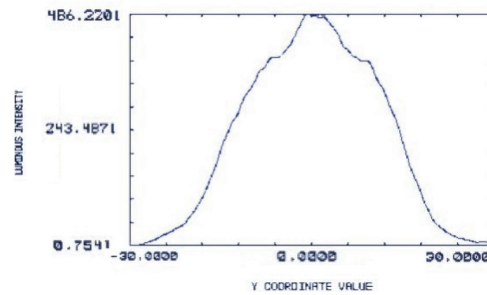

Typical half-angle divergence 15°
when using LUXEON I Cool White

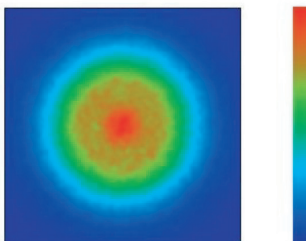

Wide Lens

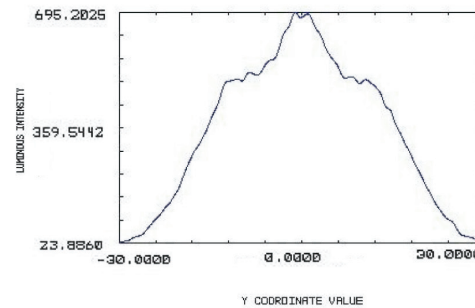

Typical half-angle divergence 25°
when using LUXEON I Cool White

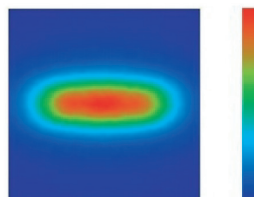

Oval Lens

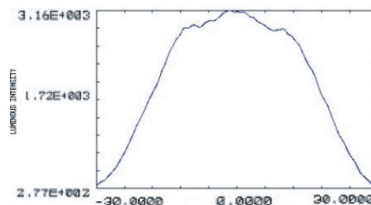

Horizontal

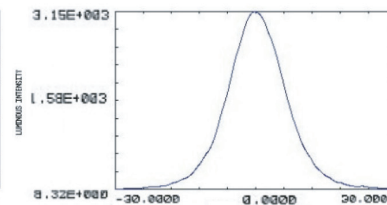

Vertical

Typ. half-angle divergence
5° X 20° LUXEON I Cool White

Dialight reserves the right to make changes at any time
in order to supply the best product possible.

Dialight Corporation
1501 Route 34 South • Farmingdale, NJ 07727 USA
Tel: (1) 732-919-3119 • Fax: (1) 732-751-5778 • www.dialight.com

