

DELPHI SERIES



FEATURES

- High efficiency: 96.6% @11V/49A
- Size:
 - open frame 57.9 x 36.8 x 11.7mm (2.28"x1.45"x0.46")
 - with heat spreader 57.9 x 36.8 x 13.2mm (2.28"x1.45"x0.52")
- Industry standard pin out
- Input OVP, UVLO; output OCP and OTP
- 2250V Isolation and basic insulation
- Monotonic startup into normal and Pre-biased loads
- No minimum load required
- Provide optional trim pin for active current sharing of parallel application
- Double output pin for better thermal and high current/power handling
- ISO 9001, TL 9000, ISO 14001, QS 9000, OHSAS 18001 certified manufacturing facility
- UL/cUL 60950-1 (US & Canada) Recognized.

Delphi Series Q48SK11049 Quarter Brick Family DC/DC Power Modules: 48V In, 11V/49A Out

The Delphi Series Q48SK11049, Quarter Brick, single output, isolated DC/DC converters are the latest offering from a world leader in power systems technology and manufacturing — Delta Electronics, Inc. The Q48SK11049 series product is a regulated Bus converter at a certain V_{in} , and the V_o will be regulated along with V_{in} with a fixed proportion; It can operate with 49A max output current from 38V to 58V V_{in} in an industry standard quarter brick footprint. At 58V input, the module provides up to 660W output power. Typical efficiency for the 48V V_{in} , 11V/49A output is 96.6%. With creative design technology and optimization of component placement, these converters possess outstanding electrical and thermal performance, as well as extremely high reliability under highly stressful operating conditions. All models are fully protected from abnormal input/output voltage, current, and temperature conditions. The Delphi Series converters meet all safety requirements with basic insulation.

OPTIONS

- Positive On/Off logic
- Short pin lengths
- Heat spreader available for extended operation.
- Additional trim pin for current sharing of parallel application

APPLICATIONS

- Telecom/DataCom
- Wireless Networks
- Optical Network Equipment
- Server and Data Storage
- Industrial/Test Equipment

DATASHEET
DS_Q48SK11049_12132012

TECHNICAL SPECIFICATIONS

($T_A=25^{\circ}\text{C}$, airflow rate=300 LFM, $V_{in}=48\text{Vdc}$, nominal V_{out} unless otherwise noted.)

PARAMETER	NOTES and CONDITIONS	Q48SK11049 (Standard)			
		Min.	Typ.	Max.	Units
ABSOLUTE MAXIMUM RATINGS					
Input Voltage					
Continuous				60	Vdc
Operating Ambient Temperature		-40		85	$^{\circ}\text{C}$
Storage Temperature		-55		125	$^{\circ}\text{C}$
Input/Output Isolation Voltage				2250	Vdc
INPUT CHARACTERISTICS					
Operating Input Voltage		38	48	58	Vdc
Input Under-Voltage Lockout					
Turn-On Voltage Threshold		34.5	36	37.5	Vdc
Turn-Off Voltage Threshold		32.5	34	35.5	Vdc
Lockout Hysteresis Voltage		1	2	3	Vdc
Input Over-Voltage Lockout					
Turn-Off Voltage Threshold		60.5	62	63.5	Vdc
Turn-On Voltage Threshold		58.5	60	61.5	Vdc
Lockout Hysteresis Voltage		1	2	3	Vdc
Maximum Input Current	$V_{in}=38\text{V}$, Full Load,			12.4	A
No-Load Input Current			110	170	mA
Off Converter Input Current			12	15	mA
Inrush Current(I^t)	Full Load, With 100 μF external input capacitor			1	A*s
Start up Current	Peak, $V_{in}=38\text{V}$, Full Load, With 5000 μF Co		16	20	A
Input Terminal Ripple Current	RMS, $V_{in}=48\text{V}$, Full Load, With 100 μF input cap.		0.22	0.44	A
Input Reflected-Ripple Current	P-P thru 12 μH inductor, 5Hz to 20MHz, $V_{in}=48\text{V}$, Full Load,		20	40	mA
OUTPUT CHARACTERISTICS					
Output Voltage Set Point	$V_{in}=48\text{V}$, Full Load, $T_c=25^{\circ}\text{C}$	10.4	10.7	11	Vdc
V_o equation (By calculation)	V_{in}	$0.87*(V_{in}/4)$	$0.89*(V_{in}/4)$	$0.91*(V_{in}/4)$	Vdc
Output Voltage Regulation					
Over Load	$I_o=I_{o,min}$ to $I_{o,max}$		120		mV
Over Line	$V_{in}=38\text{V}$ to 58V		4.4		V
Over Temperature	$T_c=40^{\circ}\text{C}$ to 125°C		+/-120		mV
Total Output Voltage Range	over sample load, and temperature	7.8		14.5	V
Output Voltage Ripple and Noise	5Hz to 20MHz bandwidth				
Peak-to-Peak	Full Load, 1 μF ceramic, 10 μF tantalum		80	150	mV
RMS	Full Load, 1 μF ceramic, 10 μF tantalum		20	60	mV
Operating Output Current Range	Full input voltage range	0		49	A
Output Over Current Protection Threshold	Output Voltage 10% Low		59	64	A
Operating Time of Hiccup Mode Over Current Protection				40	ms
DYNAMIC CHARACTERISTICS					
Output Voltage Current Transient	Full Load, 10 μF Tan & 1 μF Ceramic cap, 0.1A/ μs				
Positive Step Change in Output Current	50% $I_{o,max}$ to 75% $I_{o,max}$			300	mV
Negative Step Change in Output Current	75% $I_{o,max}$ to 50% $I_{o,max}$			300	mV
Setting Time (within 1% V_{out} nominal)				200	μs
Turn-On Transient					
Start-Up Time, From On/Off Control		15	20	40	ms
Start-Up Time, From Input		15	20	40	ms
Maximum Output Capacitance	Full load; no overshoot of V_{out} at startup			5000	μF
EFFICIENCY					
100% Load	$V_{in}=48\text{V}$, $I_o=49\text{A}$	95.8	96.6		%
60% Load	$V_{in}=48\text{V}$, $I_o=30\text{A}$	95.8	96.6		%
ISOLATION CHARACTERISTICS					
Input to Output				2250	Vdc
Isolation Resistance		10			M Ω
Isolation Capacitance			1500		pF
FEATURE CHARACTERISTICS					
Switching Frequency			160		kHz
ON/OFF Control, Negative Remote On/Off logic					
Logic Low (Module On)	$V_{on/off}$	-0.7		0.8	V
Logic High (Module Off)	$V_{on/off}$	2.0		50	V
ON/OFF Control, Positive Remote On/Off logic					
Logic Low (Module Off)	$V_{on/off}$	-0.7		0.8	V
Logic High (Module On)	$V_{on/off}$	2.0		50	V
ON/OFF Current (for both remote on/off logic)	$I_{on/off}$ at $V_{on/off}=0.0\text{V}$			1	mA
ON/OFF Current (for both remote on/off logic)	$I_{on/off}$ at $V_{on/off}=2.0\text{V}$	10			μA
Leakage Current (for both remote on/off logic)	Logic High, $V_{on/off}=15\text{V}$			50	μA
Output Voltage Trim Range		-5		0	%
GENERAL SPECIFICATIONS					
MTBF (with heat spreader)	$I_o=80\%$ of $I_{o,max}$; 300LFM; $T_a=25^{\circ}\text{C}$		1.75		M hours
Weight (without heat spreader)			53		grams
Weight (with heat spreader)			67		grams
Over-Temperature Shutdown (Without heat spreader)	Refer to Figure 18 for Hot spot 1 location (48Vin,80% I_o , 200LFM,Airflow from Vin+ to Vin-)		125		$^{\circ}\text{C}$
Over-Temperature Shutdown (With heat spreader)	Refer to Figure 20 for Hot spot 2 location (48Vin,80% I_o , 200LFM,Airflow from Vin+ to Vin-)		116		$^{\circ}\text{C}$
Over-Temperature Shutdown (NTC resistor)	Refer to Figure 18 for NTC resistor location		125		$^{\circ}\text{C}$

Note: Please attach thermocouple on NTC resistor to test OTP function, the hot spots' temperature is just for reference.

ELECTRICAL CHARACTERISTICS CURVES

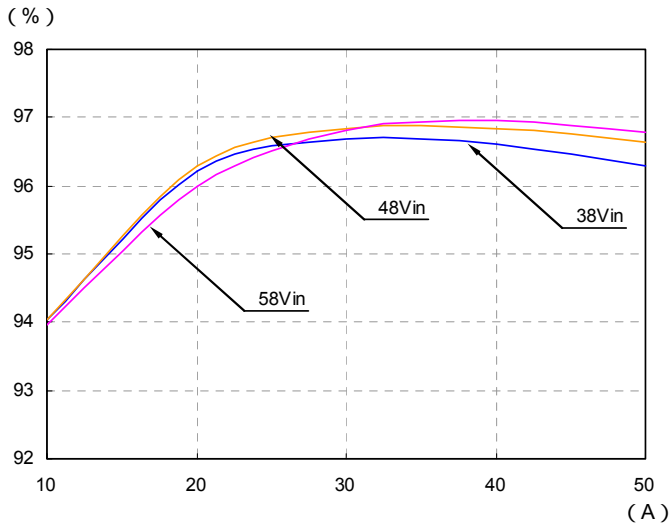

Figure 1: Efficiency vs. load current for minimum, nominal, and maximum input voltage at 25°C

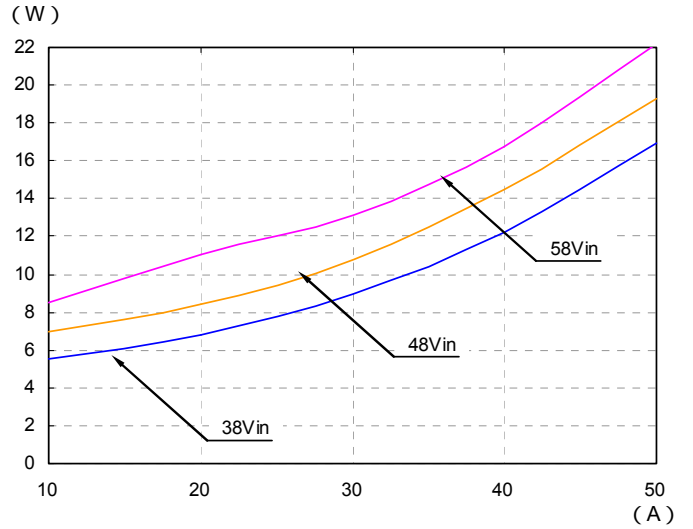

Figure 2: Power dissipation vs. load current for minimum, nominal, and maximum input voltage at 25°C

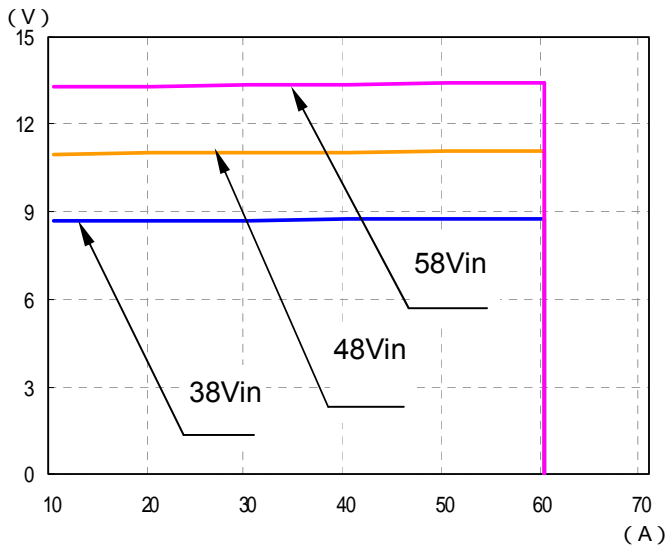

Figure 3: Output voltage regulation vs load current showing typical current limit curves and converter shutdown points for minimum, nominal, and maximum input voltage at room temperature.

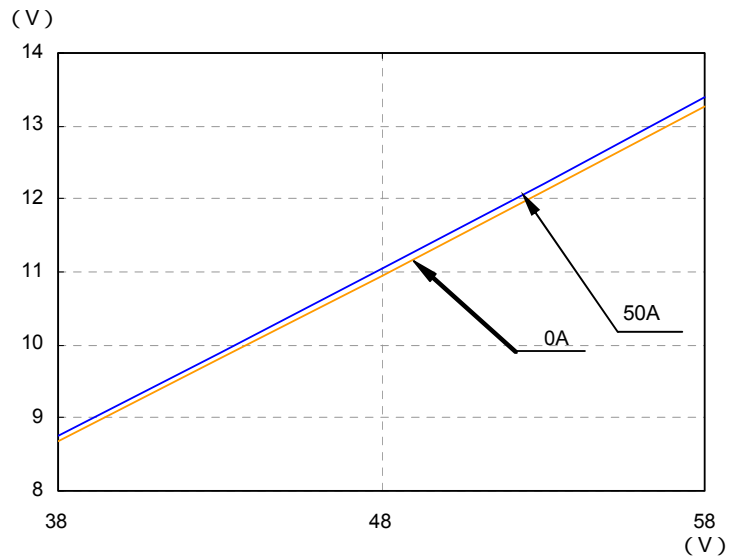

Figure 4: Output voltage regulation vs input Voltage, for minimum current and maximum current

ELECTRICAL CHARACTERISTICS CURVES

For Negative Remote On/Off Logic

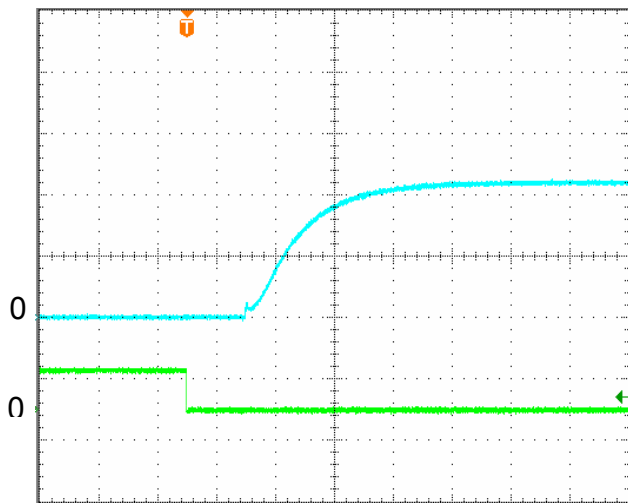

Figure 5: Turn-on transient at zero load current (10ms/div). $V_{in}=48V$. Top Trace: V_{out} , 5V/div; Bottom Trace: ON/OFF input, 5V/div

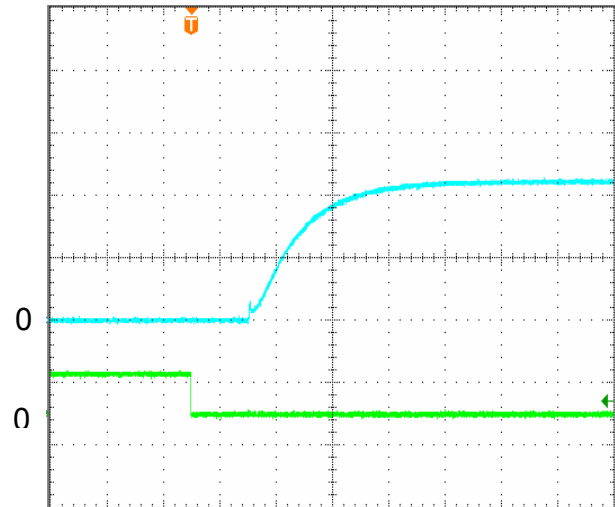

Figure 6: Turn-on transient at full rated load current (constant current load) (10 ms/div). $V_{in}=48V$. Top Trace: V_{out} , 5V/div; Bottom Trace: ON/OFF input, 5V/div

For Input Voltage Start up

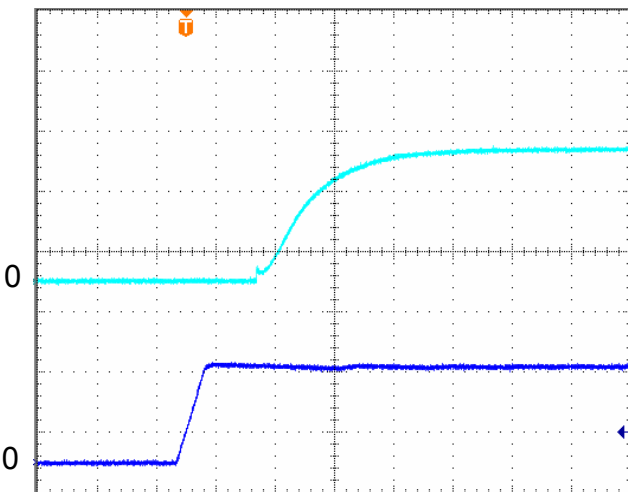

Figure 7: Turn-on transient at zero load current (10 ms/div). $V_{in}=48V$. Top Trace: V_{out} , 5V/div, Bottom Trace: input voltage, 30V/div

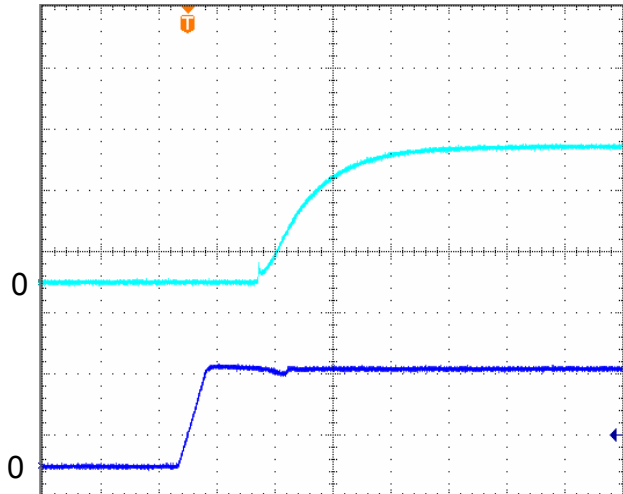

Figure 8: Turn-on transient at full rated load current (constant current load) (10 ms/div). $V_{in}=48V$. Top Trace: V_{out} , 5V/div; Bottom Trace: input voltage, 30V/div

ELECTRICAL CHARACTERISTICS CURVES

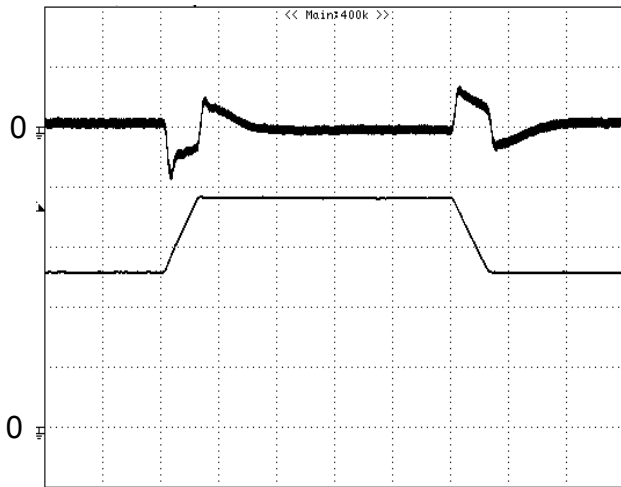

Figure 9: Output voltage response to step-change in load current (50%-75%-50% of $I_{o, max}$; $di/dt = 0.1A/\mu s$). Load cap: $10\mu F$, tantalum capacitor and $1\mu F$ ceramic capacitor. Top Trace: V_{out} (100mV/div, 200us/div), Bottom Trace: I_{out} (10A/div). Scope measurement should be made using a BNC cable (length shorter than 20 inches). Position the load between 51 mm to 76 mm (2 inches to 3 inches) from the module.

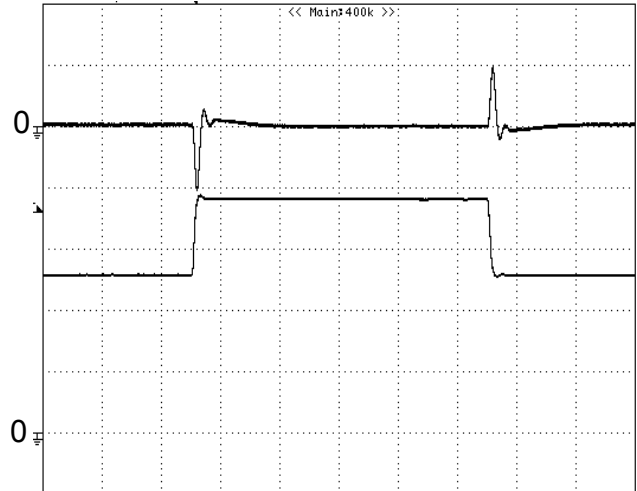

Figure 10: Output voltage response to step-change in load current (50%-75%-50% of $I_{o, max}$; $di/dt = 1A/\mu s$). Load cap: $10\mu F$, tantalum capacitor and $1\mu F$ ceramic capacitor. Top Trace: V_{out} (500mV/div, 200us/div), Bottom Trace: I_{out} (10A/div). Scope measurement should be made using a BNC cable (length shorter than 20 inches). Position the load between 51 mm to 76 mm (2 inches to 3 inches) from the module.

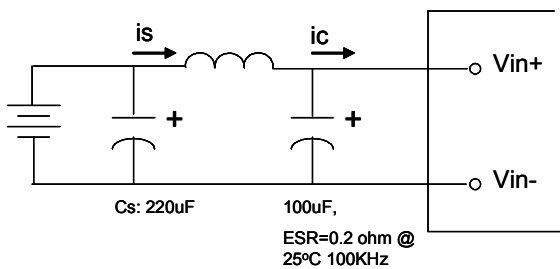

Figure 11: Test set-up diagram showing measurement points for Input Terminal Ripple Current and Input Reflected Ripple Current.

Note: Measured input reflected-ripple current with a simulated source Inductance (L_{TEST}) of $12 \mu H$. Capacitor C_s offset possible battery impedance. Measure current as shown below

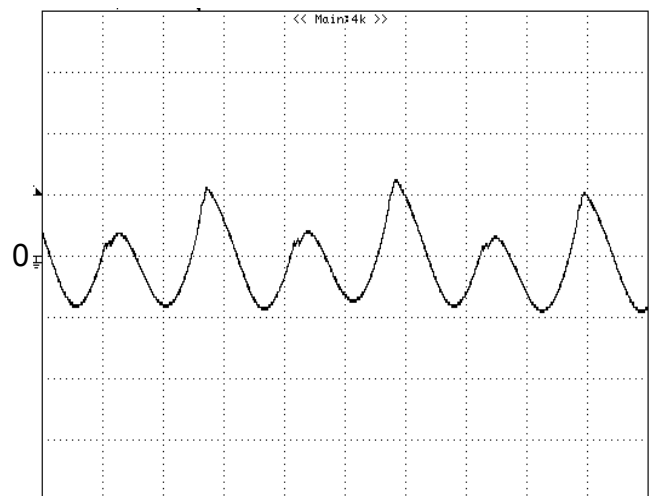

Figure 12: Input Terminal Ripple Current, i_c , at full rated output current and nominal input voltage with $12\mu H$ source impedance and $100\mu F$ electrolytic capacitor (100 mA/div, 2us/div).

ELECTRICAL CHARACTERISTICS CURVES

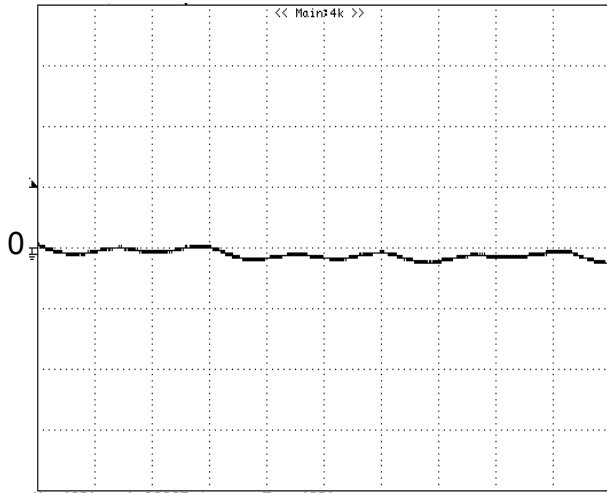

Figure 13: Input reflected ripple current, i_s , through a $12\mu\text{H}$ source inductor at nominal input voltage and rated load current (20 mA/div , $2\mu\text{s/div}$).

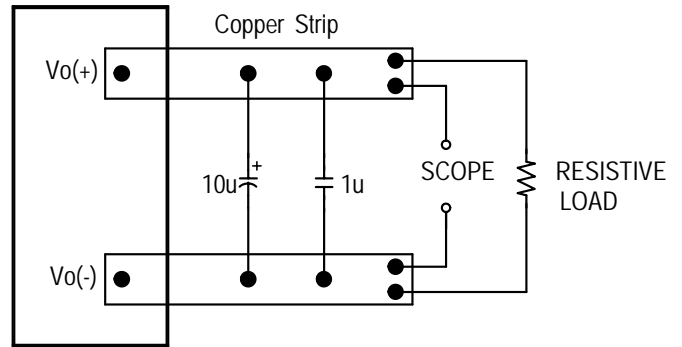

Figure 14: Output voltage noise and ripple measurement test setup

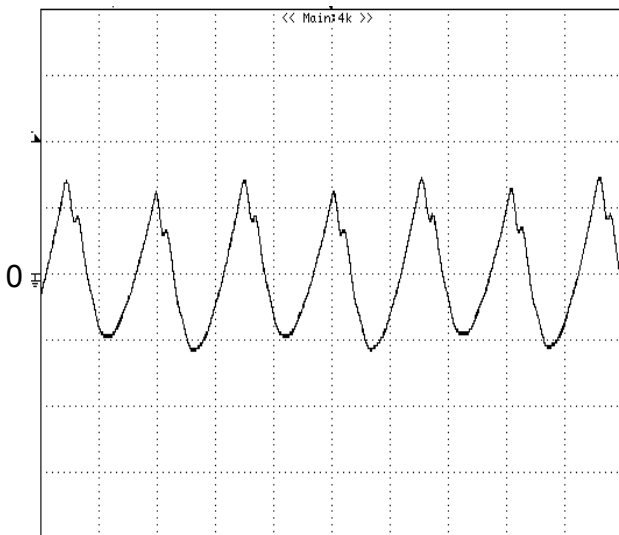

Figure 15: Output voltage ripple at nominal input voltage and rated full load current (20 mV/div , $2\mu\text{s/div}$)
 Load capacitance: $1\mu\text{F}$ ceramic capacitor and $10\mu\text{F}$ tantalum capacitor. Bandwidth: 20 MHz . Scope measurements should be made using a BNC cable (length shorter than 20 inches). Position the load between 51 mm to 76 mm (2 inches to 3 inches) from the module.

DESIGN CONSIDERATIONS

Input Source Impedance

The impedance of the input source connecting to the DC/DC power modules will interact with the modules and affect the stability. A low ac-impedance input source is recommended. If the source inductance is more than a few μH , we advise adding a 33 to 100 μF electrolytic capacitor (ESR < 0.7 Ω at 100 kHz) mounted close to the input of the module to improve the stability.

Layout and EMC Considerations

Delta's DC/DC power modules are designed to operate in a wide variety of systems and applications. For design assistance with EMC compliance and related PWB layout issues, please contact Delta's technical support team. An external input filter module is available for easier EMC compliance design. Below is the reference design for an input filter tested with Q48SK11049XXXX to meet class B in CISPR 22.

Schematic and Components List

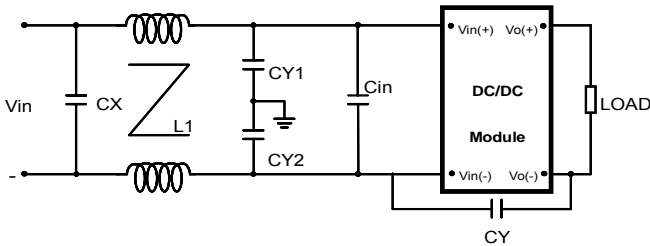

Cin is 100 μF *2 low ESR Aluminum cap;
 CX is 2.2 μF ceramic cap;
 CY1 are 10nF ceramic caps;
 CY2 are 10nF ceramic caps;
 CY is 1nF ceramic cap;
 L1 is common-mode inductor, L1=0.53mH;

Test Result

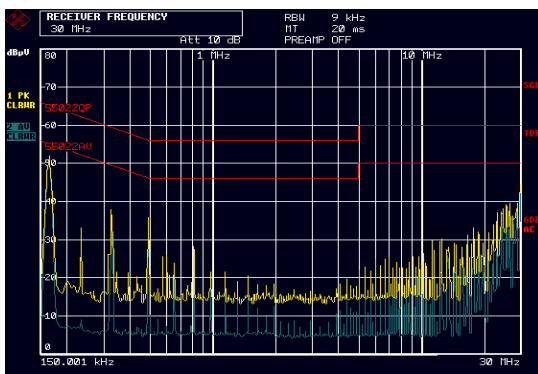

48V Vin, Full Load
 Yellow line is quasi peak mode;
 Blue line is average mode.

Safety Considerations

The power module must be installed in compliance with the spacing and separation requirements of the end-user's safety agency standard, i.e., UL60950-1, CSA C22.2 NO. 60950-1 2nd and IEC 60950-1 2nd : 2005 and EN 60950-1 2nd: 2006+A11+A1: 2010. If the system in which the power module is to be used must meet safety agency requirements.

Basic insulation based on 75 Vdc input is provided between the input and output of the module for the purpose of applying insulation requirements when the input to this DC-to-DC converter is identified as TNV-2 or SELV. An additional evaluation is needed if the source is other than TNV-2 or SELV.

When the input source is SELV circuit, the power module meets SELV (safety extra-low voltage) requirements. If the input source is a hazardous voltage which is greater than 60 Vdc and less than or equal to 75 Vdc, for the module's output to meet SELV requirements, all of the following must be met:

- The input source must be insulated from the ac mains by reinforced or double insulation.
- The input terminals of the module are not operator accessible.
- A SELV reliability test is conducted on the system where the module is used, in combination with the module, to ensure that under a single fault, hazardous voltage does not appear at the module's output.

When installed into a Class II equipment (without grounding), spacing consideration should be given to the end-use installation, as the spacing between the module and mounting surface have not been evaluated.

The power module has extra-low voltage (ELV) outputs when all inputs are ELV.

This power module is not internally fused. To achieve optimum safety and system protection, an input line fuse is highly recommended. The safety agencies require a Fast-acting fuse with 30A maximum rating to be installed in the ungrounded lead. A lower rated fuse can be used based on the maximum inrush transient energy and maximum input current.

Soldering and Cleaning Considerations

Post solder cleaning is usually the final board assembly process before the board or system undergoes electrical testing. Inadequate cleaning and/or drying may lower the reliability of a power module and severely affect the finished circuit board assembly test. Adequate cleaning and/or drying is especially important for un-encapsulated and/or open frame type power modules. For assistance on appropriate soldering and cleaning procedures, please contact Delta's technical support team.



FEATURES DESCRIPTIONS

Over-Current Protection

The modules include an internal output over-current protection circuit, which will endure current limiting for an unlimited duration during output overload. If the output current exceeds the OCP set point, the modules will automatically shut down, and enter hiccup mode.

For the hiccup mode, the module will try to restart after shutdown. If the overload condition still exists, the module will shut down again. This restart trial will continue until the overload condition is corrected.

Over-Temperature Protection

The over-temperature protection consists of circuitry that provides protection from thermal damage. If the temperature exceeds the over-temperature threshold the module will shut down, and enter in auto-restart mode.

For the auto-restart mode, the module will monitor the module temperature after shutdown. Once the temperature is dropped and within the specification, the module will be auto-restart.

Remote On/Off

The remote on/off feature on the module can be either negative or positive logic. Negative logic turns the module on during a logic low and off during a logic high. Positive logic turns the modules on during a logic high and off during a logic low.

Remote on/off can be controlled by an external switch between the on/off terminal and the Vi(-) terminal. The switch can be an open collector or open drain.

For negative logic if the remote on/off feature is not used, please short the on/off pin to Vi(-). For positive logic if the remote on/off feature is not used, please leave the on/off pin floating.

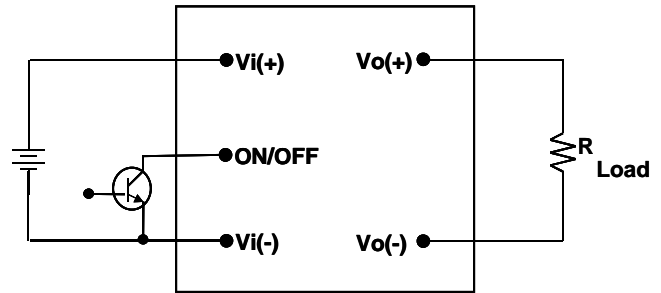

Figure 16: Remote on/off implementation

THERMAL CONSIDERATIONS

Thermal management is an important part of the system design. To ensure proper, reliable operation, sufficient cooling of the power module is needed over the entire temperature range of the module. Convection cooling is usually the dominant mode of heat transfer.

Hence, the choice of equipment to characterize the thermal performance of the power module is a wind tunnel.

Thermal Testing Setup

Delta's DC/DC power modules are characterized in heated vertical wind tunnels that simulate the thermal environments encountered in most electronics equipment. This type of equipment commonly uses vertically mounted circuit cards in cabinet racks in which the power modules are mounted.

The following figure shows the wind tunnel characterization setup. The power module is mounted on a test PWB and is vertically positioned within the wind tunnel. The space between the neighboring PWB and the top of the power module is constantly kept at 6.35mm (0.25").

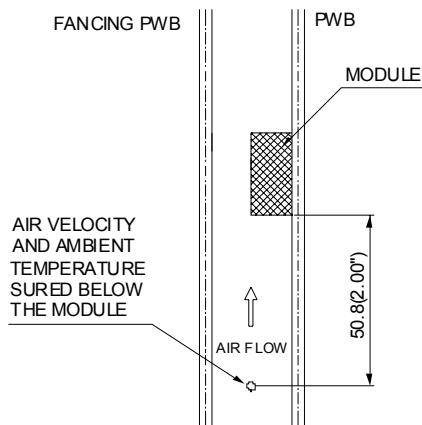

Note: Wind Tunnel Test Setup Figure Dimensions are in millimeters and (Inches)

Figure 17: Wind tunnel test setup

Thermal Derating

Heat can be removed by increasing airflow over the module. To enhance system reliability; the power module should always be operated below the maximum operating temperature. If the temperature exceeds the maximum module temperature, reliability of the unit may be affected.

THERMAL CURVES (WITHOUT HEAT SPREADER)

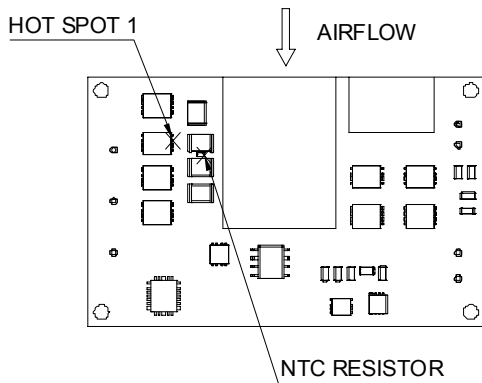

Figure 18: * Hot spot 1 & NTC resistor temperature measured points

THERMAL CURVES (WITH HEAT SPREADER)

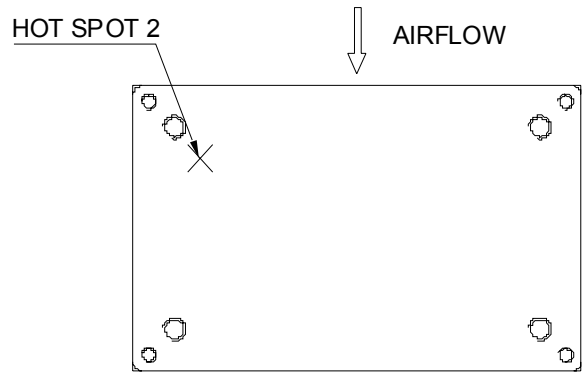

Figure 20: * Hot spot 2 temperature measured point

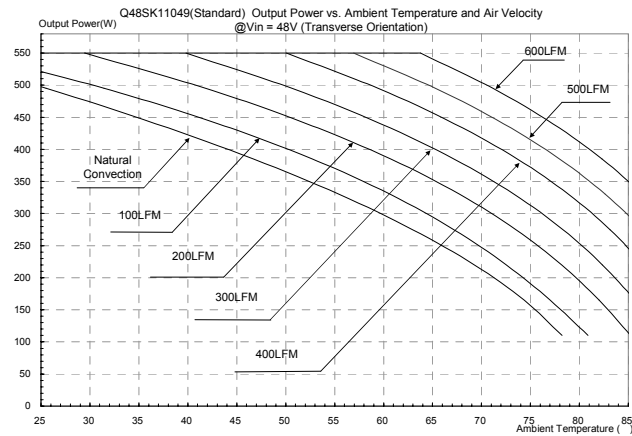

Figure 19: Output power vs. ambient temperature and air velocity @Vin=48V(Transverse Orientation, airflow from Vin+ to Vin-, without heat spreader)

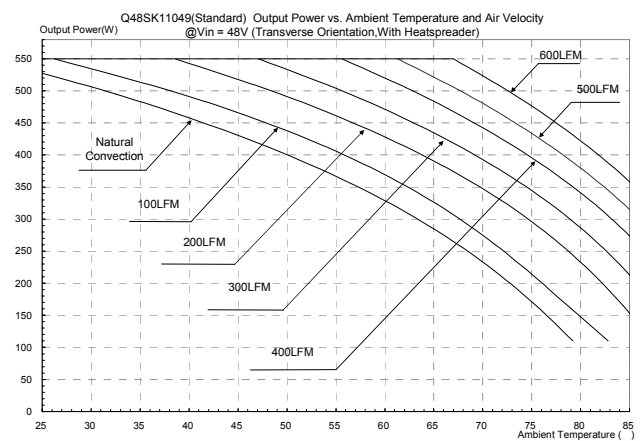
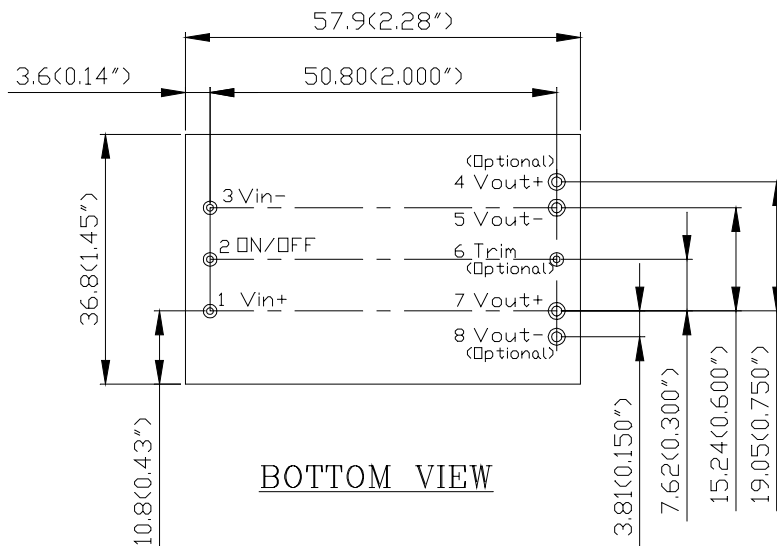
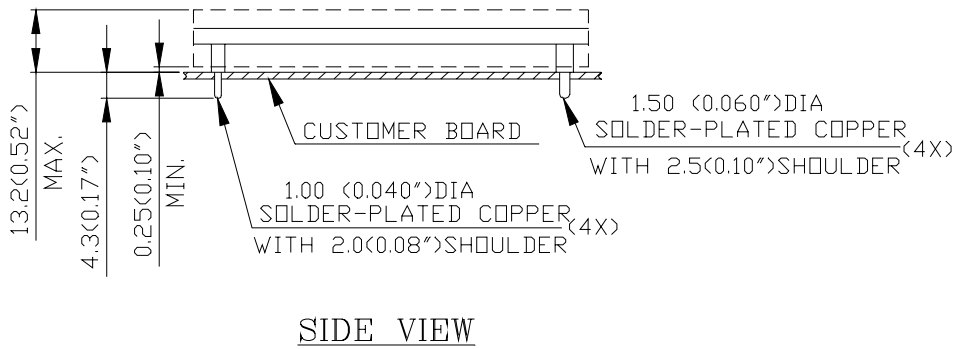
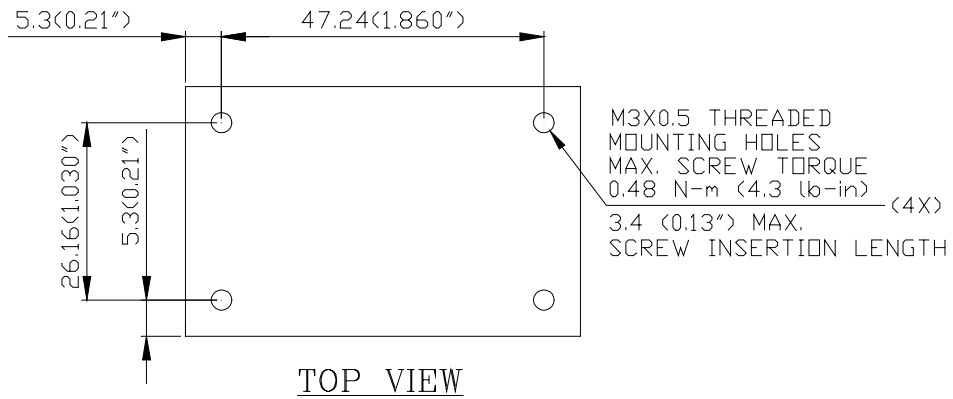

Figure 21: Output power vs. ambient temperature and air velocity @Vin=48V(Transverse Orientation, airflow from Vin+ to Vin-, with heat spreader)

MECHANICAL DRAWING (WITH HEAT SPREADER)

* For modules with through-hole pins and the optional heatspreader, they are intended for wave soldering assembly onto system boards; please do not subject such modules through reflow temperature profile.



NOTES:
 DIMENSIONS ARE IN MILLIMETERS AND (INCHES)
 TOLERANCES: X.Xmm±0.5mm(X.XX in.±0.02 in.)
 X.XXmm±0.25mm(X.XXX in.±0.010 in.)

MECHANICAL DRAWING (WITHOUT HEAT SPREADER)

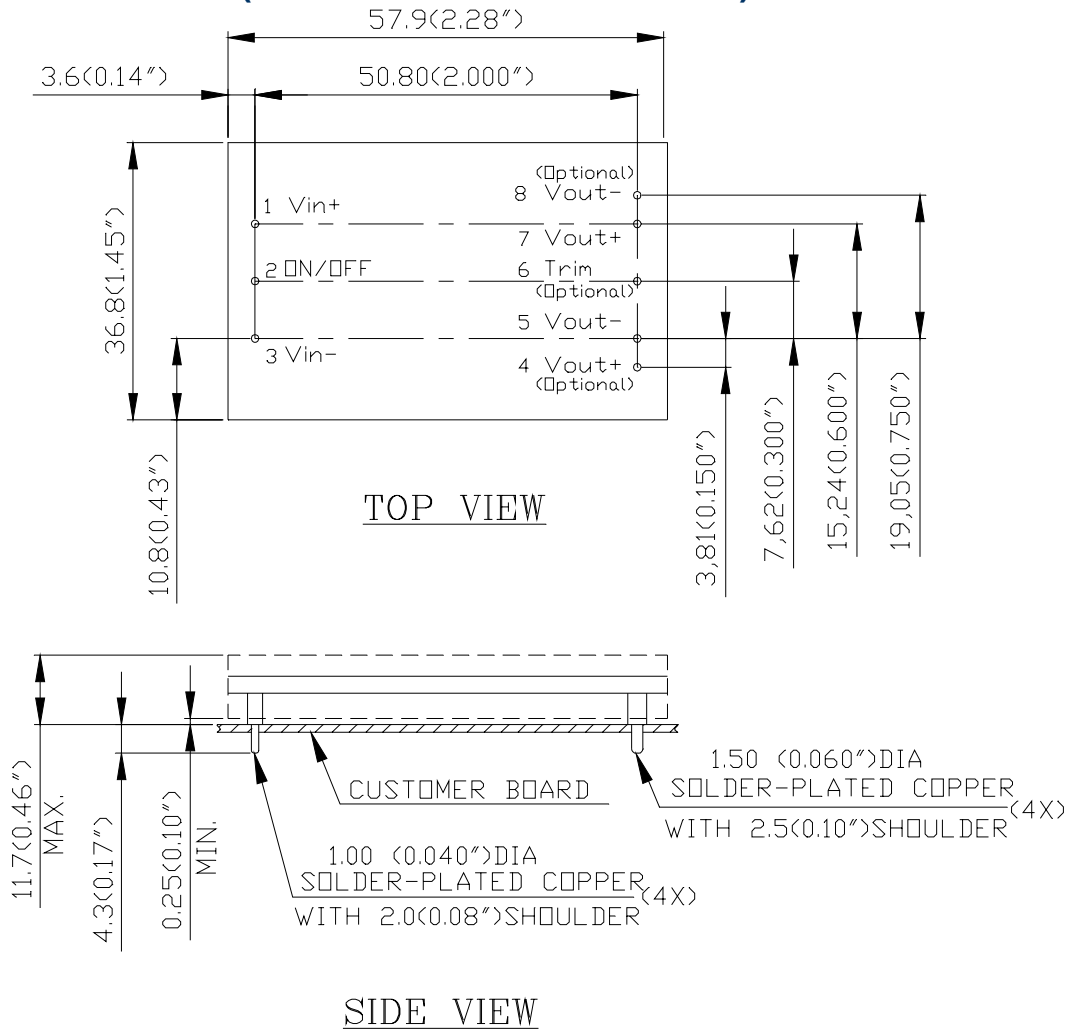

NOTES:

DIMENSIONS ARE IN MILLIMETERS AND (INCHES)

TOLERANCES: X.Xmm±0.5mm(X.XX in.±0.02 in.)

X.XXmm±0.25mm(X.XXX in.±0.010 in.)

Pin No.	Name	Function
1	+Vin	Positive input voltage
2	ON/OFF	Remote ON/OFF
3	-Vin	Negative input voltage
4	+Vout	Positive output voltage (Optional)
5	-Vout	Negative output voltage
6	Trim	Output voltage trim(optional)
7	+Vout	Positive output voltage
8	-Vout	Negative output voltage (Optional)

Pin Specification:

Pins 1,2,3,6 1.00mm (0.040") diameter
Pins 4,5,7,8 1.50mm (0.059") diameter

All pins are copper with matte Tin plating over Nickel under plating.

PART NUMBERING SYSTEM

Q	48	S	K	110	49	N	R	F	A
Type of Product	Input Voltage	Number of Outputs	Product Series	Output Voltage	Output Current	ON/OFF Logic	Pin Length/Type		Option Code
Q - Quarter Brick	48-38V~58V	S- Single	K – High Power	110 - 11V	49 - 49A	N- Negative P- Positive	K- 0.110" N- 0.145" R- 0.170" C - 0.181" S - 0.189" T - 0.220" L - 0.248"	F- RoHS 6/6 (Lead Free)	T- 8PIN, without heat spreader A- open frame, without trim pin H- with heat spreader, without trim pin C- open frame, void pin4,6,8

MODEL LIST

MODEL NAME	INPUT		OUTPUT		EFF @ 100% LOAD
Q48SK11049NRFA	38V~58V	14A	11V	49A	96.6%
Q48SK11049NRFT	38V~58V	14A	11V	49A	96.6%
Q48SK11049NRFH	38V~58V	14A	11V	49A	96.6%

1. Default remote on/off logic is negative and pin length is 0.170";
2. No Trim pin is default;
3. For different remote on/off logic and pin length, please refer to part numbering system above or contact your local sales.

*** For modules with through-hole pins and the optional heatspreader, they are intended for wave soldering assembly onto system boards; please do not subject such modules through reflow temperature profile.**

CONTACT: www.delta.com.tw/dcdc

USA:

Telephone:
East Coast: 978-656-3993
West Coast: 510-668-5100
Fax: (978) 656 3964
Email: DCDC@delta-corp.com

Europe:

Telephone: +41 31 998 53 11
Fax: +41 31 998 53 53
Email: DCDC@delta-es.tw

Asia & the rest of world:

Telephone: +886 3 4526107 x 6220~6224
Fax: +886 3 4513485
Email: DCDC@delta.com.tw

WARRANTY

Delta offers a two (2) year limited warranty. Complete warranty information is listed on our web site or is available upon request from Delta.

Information furnished by Delta is believed to be accurate and reliable. However, no responsibility is assumed by Delta for its use, nor for any infringements of patents or other rights of third parties, which may result from its use. No license is granted by implication or otherwise under any patent or patent rights of Delta. Delta reserves the right to revise these specifications at any time, without notice.