



Custom Cable Assemblies  
Drawing #

1-NPT/603-1342-ND

701 Brooks Avenue South, Thief River Falls, MN 56701 phone: 800-344-4539 fax: 218-681-3380

DATE 12/4/2014

QUOTE # \_\_\_\_\_

CUSTOMER # \_\_\_\_\_

COMPANY \_\_\_\_\_

NAME \_\_\_\_\_

PHONE \_\_\_\_\_

FAX \_\_\_\_\_

Drawn By A3GV

Description: (32 character max)

603-1342-ND/ WM2312TR-ND / WM2001-ND

\_\_\_\_\_

\_\_\_\_\_

\_\_\_\_\_

Assembly Components	
Part #	Qty.
603-1342-ND	1
WM2312TR-ND	3
WM2001-ND	1
Cable Part #	
N/A	
Cable Color:	
N/A	
Cable Length:	
Standard	
Cable Tolerance:	
-/+ .25"	

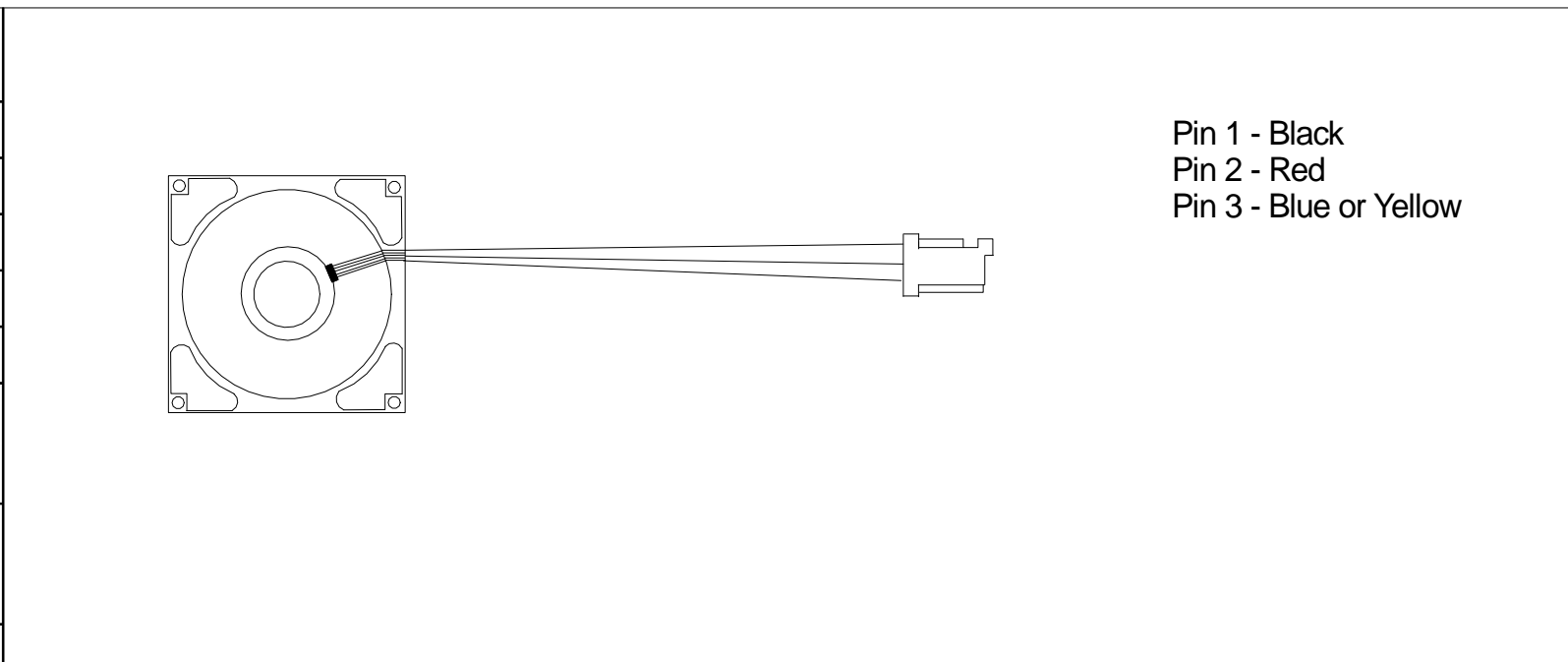

Special Instructions: Leave wire length standard. Cut, strip, and crimp wire ends

\_\_\_\_\_

\_\_\_\_\_

I have reviewed and approved the above custom cable drawing, Signed \_\_\_\_\_