

512K x 8 Static RAM

Features

- **High speed**
— $t_{AA} = 10$ ns
- **Low active power**
— 324 mW (max.)
- **2.0V data retention**
- **Automatic power-down when deselected**
- **TTL-compatible inputs and outputs**
- **Easy memory expansion with CE and OE features**

Functional Description^[1]

The CY7C1049CV33 is a high-performance CMOS Static RAM organized as 524,288 words by 8 bits. Easy memory expansion is provided by an active LOW Chip Enable (CE), an active LOW Output Enable (OE), and three-state drivers.

Writing to the device is accomplished by taking Chip Enable (CE) and Write Enable (WE) inputs LOW. Data on the eight I/O pins (I/O₀ through I/O₇) is then written into the location specified on the address pins (A₀ through A₁₈).

Reading from the device is accomplished by taking Chip Enable (CE) and Output Enable (OE) LOW while forcing Write Enable (WE) HIGH. Under these conditions, the contents of the memory location specified by the address pins will appear on the I/O pins.

The eight input/output pins (I/O₀ through I/O₇) are placed in a high-impedance state when the device is deselected (CE HIGH), the outputs are disabled (OE HIGH), or during a Write operation (CE LOW, and WE LOW).

The CY7C1049CV33 is available in standard 400-mil-wide 36-pin SOJ package and 44-pin TSOP II package with center power and ground (revolutionary) pinout.

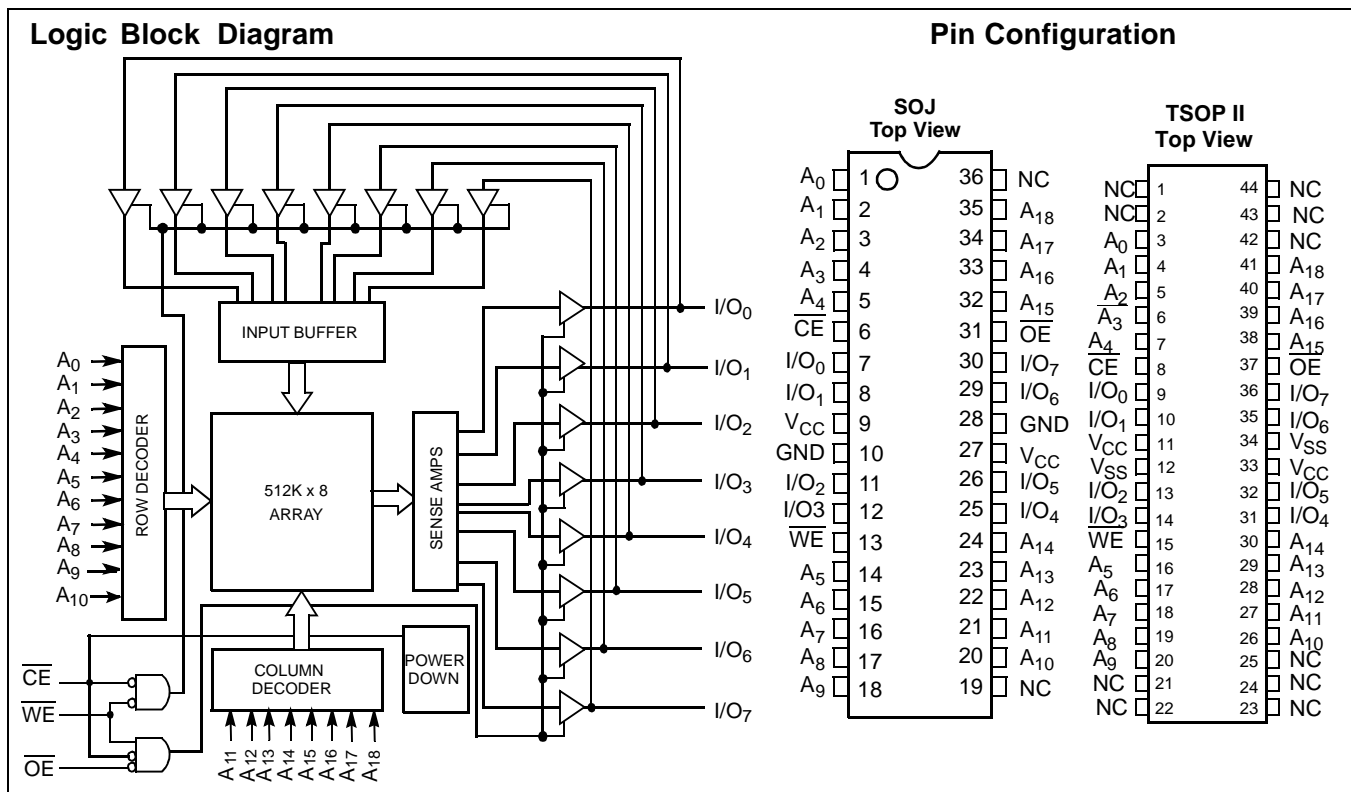

Selection Guide

		-8 ^[2]	-10	-12	-15	Unit
Maximum Access Time		8	10	12	15	ns
Maximum Operating Current	Commercial	100	90	85	80	mA
	Industrial	110	100	95	90	mA
Maximum CMOS Standby Current	Commercial / Industrial	10	10	10	10	mA

Notes:

1. For guidelines on SRAM system design, please refer to the 'System Design Guidelines' Cypress application note, available on the internet at www.cypress.com.
2. Shaded areas contain advance information.

Maximum Ratings

(Above which the useful life may be impaired. For user guidelines, not tested.)

Storage Temperature -65°C to +150°C
 Ambient Temperature with Power Applied..... -55°C to +125°C
 Supply Voltage on V_{CC} to Relative GND^[3] -0.5V to +4.6V

DC Voltage Applied to Outputs in High-Z State^[3].....

..... -0.5V to V_{CC} + 0.5V

DC Input Voltage^[3] -0.5V to V_{CC} + 0.5V

Current into Outputs (LOW)..... 20 mA

Operating Range

Range	Ambient Temperature	V _{CC}
Commercial	0°C to +70°C	3.3V ± 0.3V
Industrial	-40°C to +85°C	

Electrical Characteristics Over the Operating Range

Parameter	Description	Test Conditions	-8 ^[2]		-10		-12		-15		Unit
			Min.	Max.	Min.	Max.	Min.	Max.	Min.	Max.	
V _{OH}	Output HIGH Voltage	V _{CC} = Min.; I _{OH} = -4.0 mA	2.4		2.4		2.4		2.4		V
V _{OL}	Output LOW Voltage	V _{CC} = Min.; I _{OL} = 8.0 mA		0.4		0.4		0.4		0.4	V
V _{IH}	Input HIGH Voltage		2.0	V _{CC} + 0.3	2.0	V _{CC} + 0.3	2.0	V _{CC} + 0.3	2.0	V _{CC} + 0.3	V
V _{IL}	Input LOW Voltage ^[3]		-0.3	0.8	-0.3	0.8	-0.3	0.8	-0.3	0.8	V
I _{IX}	Input Load Current	GND ≤ V _I ≤ V _{CC}	-1	+1	-1	+1	-1	+1	-1	+1	μA
I _{OZ}	Output Leakage Current	GND ≤ V _{OUT} ≤ V _{CC} , Output Disabled	-1	+1	-1	+1	-1	+1	-1	+1	μA
I _{CC}	V _{CC} Operating Supply Current	V _{CC} = Max., f = f _{MAX} = 1/t _{RC}		100		90		85		80	mA
		Comm'l				100		95		90	mA
I _{SB1}	Automatic CE Power-down Current —TTL Inputs	Max. V _{CC} , CE ≥ V _{IH} ; V _{IN} ≥ V _{IH} or V _{IN} ≤ V _{IL} , f = f _{MAX}		40		40		40		40	mA
			Ind'l								
I _{SB2}	Automatic CE Power-down Current —CMOS Inputs	Max. V _{CC} , CE ≥ V _{CC} - 0.3V, V _{IN} ≥ V _{CC} - 0.3V, or V _{IN} ≤ 0.3V, f = 0		10		10		10		10	mA
			Com'l/Ind'l								

Capacitance^[4]

Parameter	Description	Test Conditions	Max.	Unit
C _{IN}	Input Capacitance	T _A = 25°C, f = 1 MHz,	8	pF
C _{OUT}	I/O Capacitance	V _{CC} = 3.3V	8	pF

AC Test Loads and Waveforms^[5]

8-, 10-ns devices:

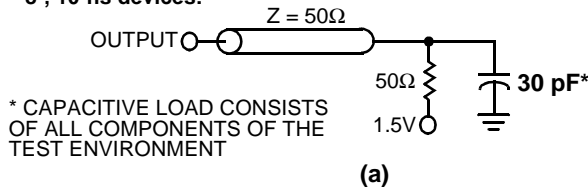

12-, 15-ns devices:

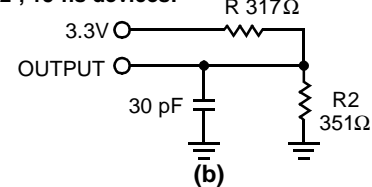

High-Z characteristics:

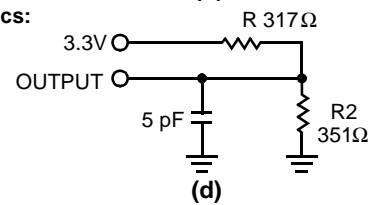
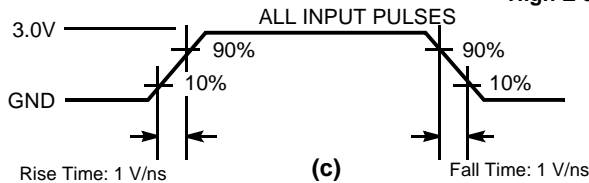
Notes:

- V_{IL} (min.) = -2.0V for pulse durations of less than 20 ns.
- Tested initially and after any design or process changes that may affect these parameters.
- AC characteristics (except High-Z) for all 8-ns and 10-ns parts are tested using the load conditions shown in Figure (a). All other speeds are tested using the Thevenin load shown in Figure (b). High-Z characteristics are tested for all speeds using the test load shown in Figure (d).

AC Switching Characteristics^[6] Over the Operating Range

Parameter	Description	-8 ^[2]		-10		-12		-15		Unit
		Min.	Max.	Min.	Max.	Min.	Max.	Min.	Max.	
Read Cycle										
$t_{power}^{[7]}$	V_{CC} (typical) to the first access	1		1		1		1		μs
t_{RC}	Read Cycle Time	8		10		12		15		ns
t_{AA}	Address to Data Valid		8		10		12		15	ns
t_{OHA}	Data Hold from Address Change	3		3		3		3		ns
t_{ACE}	\overline{CE} LOW to Data Valid		8		10		12		15	ns
t_{DOE}	\overline{OE} LOW to Data Valid		4		5		6		7	ns
t_{LZOE}	\overline{OE} LOW to Low-Z	0		0		0		0		ns
t_{HZOE}	\overline{OE} HIGH to High-Z ^[8, 9]		4		5		6		7	ns
t_{LZCE}	\overline{CE} LOW to Low-Z ^[9]	3		3		3		3		ns
t_{HZCE}	\overline{CE} HIGH to High-Z ^[8, 9]		4		5		6		7	ns
t_{PU}	\overline{CE} LOW to Power-up	0		0		0		0		ns
t_{PD}	\overline{CE} HIGH to Power-down		8		10		12		15	ns
Write Cycle^[10, 11]										
t_{WC}	Write Cycle Time	8		10		12		15		ns
t_{SCE}	\overline{CE} LOW to Write End	6		7		8		10		ns
t_{AW}	Address Set-up to Write End	6		7		8		10		ns
t_{HA}	Address Hold from Write End	0		0		0		0		ns
t_{SA}	Address Set-up to Write Start	0		0		0		0		ns
t_{PWE}	\overline{WE} Pulse Width	6		7		8		10		ns
t_{SD}	Data Set-up to Write End	4		5		6		7		ns
t_{HD}	Data Hold from Write End	0		0		0		0		ns
t_{LZWE}	\overline{WE} HIGH to Low-Z ^[9]	3		3		3		3		ns
t_{HZWE}	\overline{WE} LOW to High-Z ^[8, 9]		4		5		6		7	ns

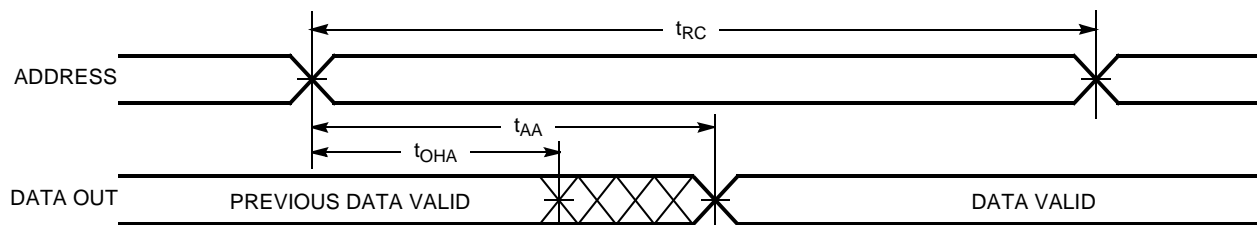
Switching Waveforms
Read Cycle No. 1^[12, 13]

Notes:

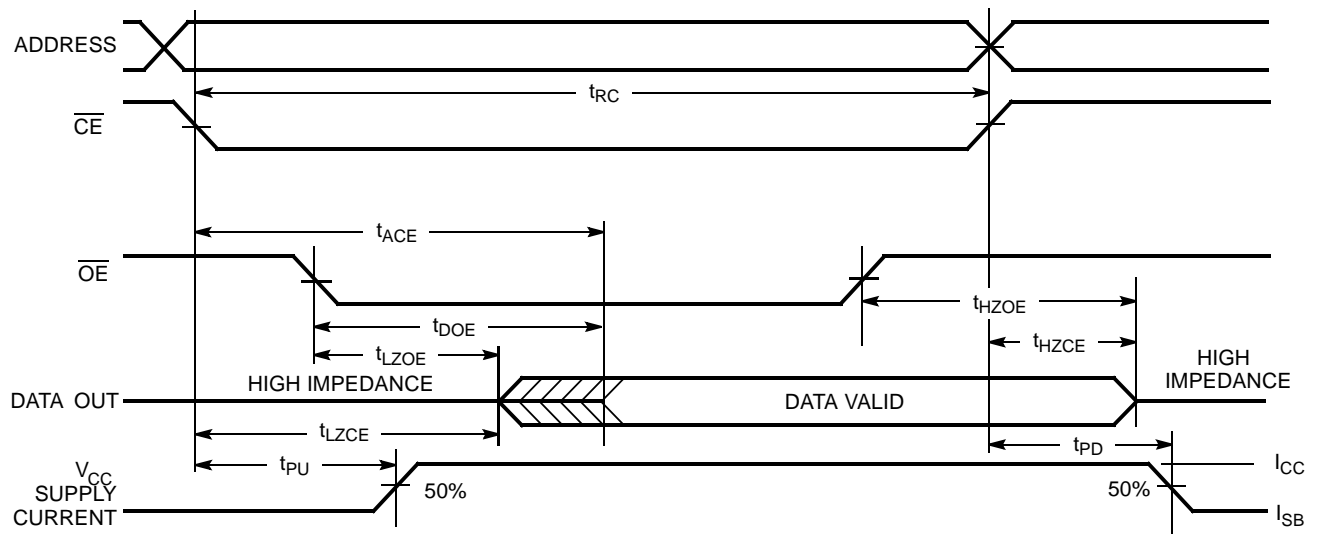
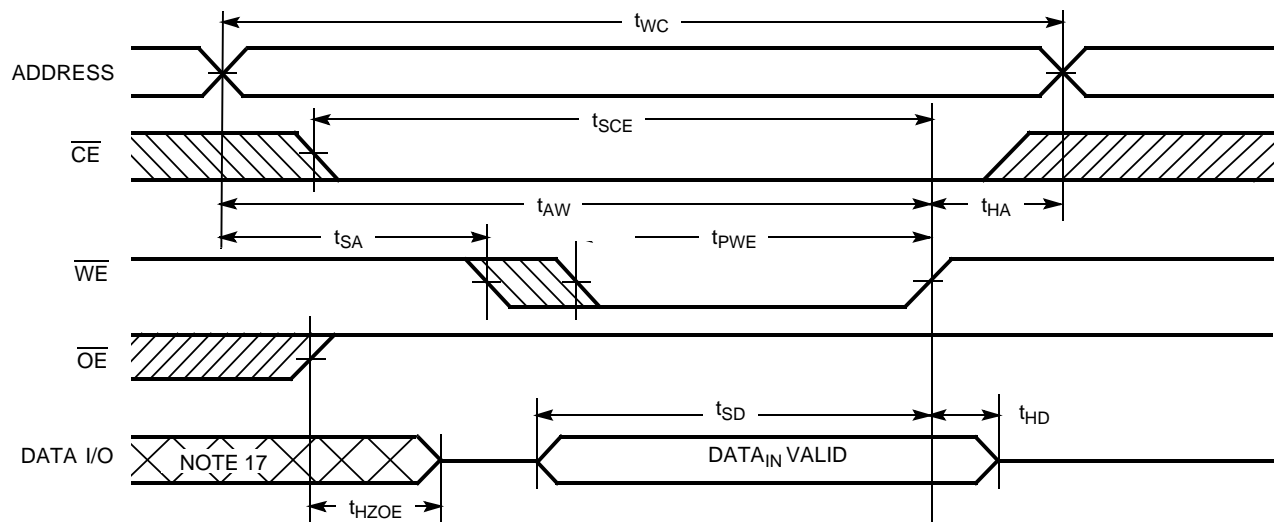
6. Test conditions assume signal transition time of 3 ns or less, timing reference levels of 1.5V, input pulse levels of 0 to 3.0V.
7. t_{POWER} gives the minimum amount of time that the power supply should be at stable, typical V_{CC} values until the first memory access can be performed.
8. t_{HZOE} , t_{HZCE} , and t_{HZWE} are specified with a load capacitance of 5 pF as in part (d) of AC Test Loads. Transition is measured ± 500 mV from steady-state voltage.
9. At any given temperature and voltage condition, t_{HZCE} is less than t_{LZCE} , t_{HZOE} is less than t_{LZOE} , and t_{HZWE} is less than t_{LZWE} for any given device.
10. The internal Write time of the memory is defined by the overlap of \overline{CE} LOW, and \overline{WE} LOW. \overline{CE} and \overline{WE} must be LOW to initiate a Write, and the transition of either of these signals can terminate the Write. The input data set-up and hold timing should be referenced to the leading edge of the signal that terminates the Write.
11. The minimum Write cycle time for Write Cycle No. 3 (\overline{WE} controlled, \overline{OE} LOW) is the sum of t_{HZWE} and t_{SD} .
12. Device is continuously selected. \overline{OE} , $\overline{CE} = V_{LL}$.
13. \overline{WE} is HIGH for Read cycle.

Switching Waveforms (continued)
Read Cycle No. 2 (\overline{OE} Controlled)^[13, 14]

Write Cycle No. 1 (\overline{WE} Controlled, \overline{OE} HIGH During Write)^[15, 16]

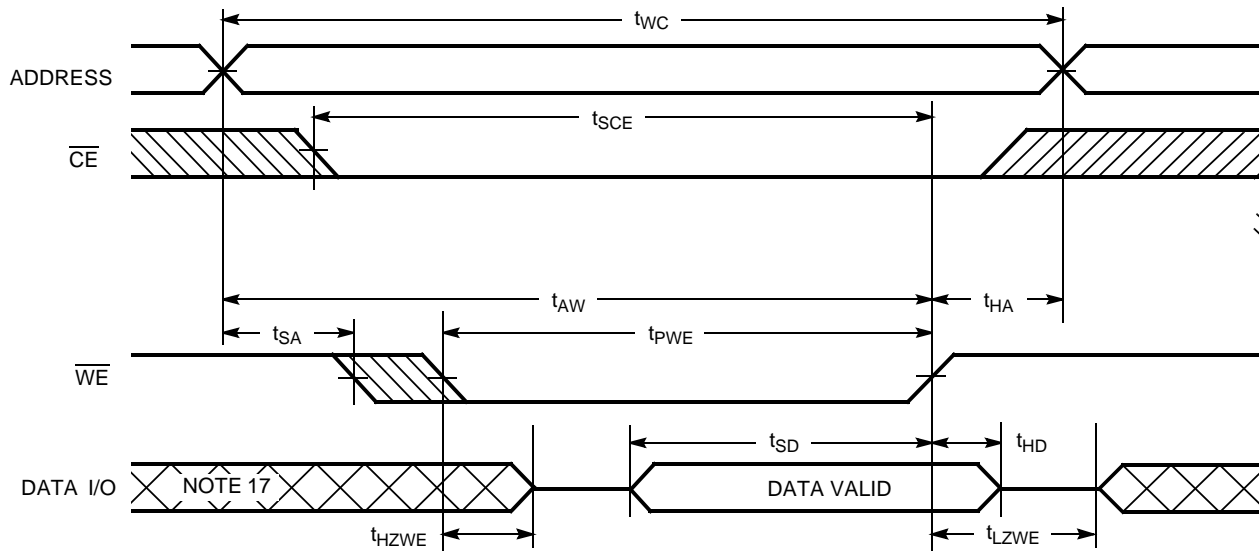
Notes:

14. Address valid prior to or coincident with \overline{CE} transition LOW.
15. Data I/O is high-impedance if $OE = V_{IH}$.
16. If \overline{CE} goes HIGH simultaneously with \overline{WE} going HIGH, the output remains in a high-impedance state.
17. During this period the I/Os are in the output state and input signals should not be applied.

Switching Waveforms (continued)

Write Cycle No. 2 (\overline{WE} Controlled, \overline{OE} LOW)^[16]

Truth Table

CE	OE	WE	I/O ₀ -I/O ₇	Mode	Power
H	X	X	High-Z	Power-down	Standby (I_{SB})
L	L	H	Data Out	Read	Active (I_{CC})
L	X	L	Data In	Write	Active (I_{CC})
L	H	H	High-Z	Selected, Outputs Disabled	Active (I_{CC})

Ordering Information

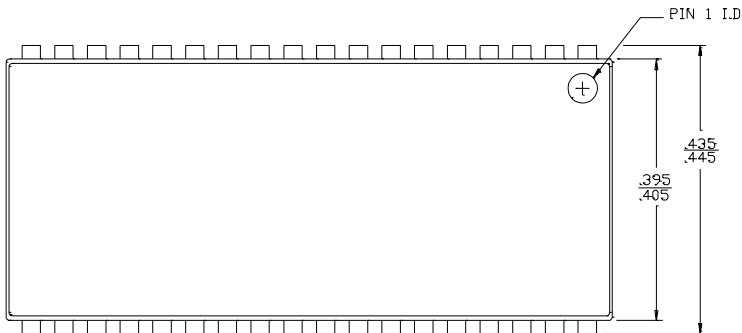
Speed (ns)	Ordering Code	Package Name	Package Type	Operating Range
10	CY7C1049CV33-10VC	V36	36-lead (400-Mil) Molded SOJ	Commercial
	CY7C1049CV33-10ZC	Z44	44-pin TSOP II	
	CY7C1049CV33-10VI	V36	36-lead (400-Mil) Molded SOJ	Industrial
	CY7C1049CV33-10ZI	Z44	44-pin TSOP II	
12	CY7C1049CV33-12VC	V36	36-lead (400-Mil) Molded SOJ	Commercial
	CY7C1049CV33-12ZC	Z44	44-pin TSOP II	
	CY7C1049CV33-12VI	V36	36-lead (400-Mil) Molded SOJ	Industrial
	CY7C1049CV33-12ZI	Z44	44-pin TSOP II	
15	CY7C1049CV33-15VC	V36	36-lead (400-Mil) Molded SOJ	Commercial
	CY7C1049CV33-15ZC	Z44	44-pin TSOP II	
	CY7C1049CV33-15VI	V36	36-lead (400-Mil) Molded SOJ	Industrial
	CY7C1049CV33-15ZI	Z44	44-pin TSOP II	

Package Diagrams
36-lead (400-mil) Molded SOJ V36

 DIMENSIONS IN INCHES
 MIN.
 MAX.

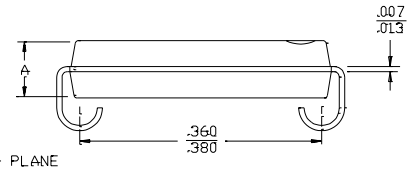
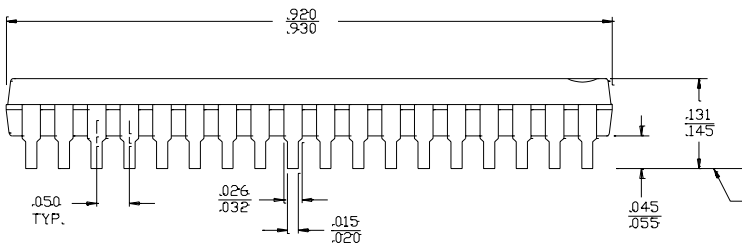
DIM. A	
ANAM	CSPI
.086	.095
.090	.115

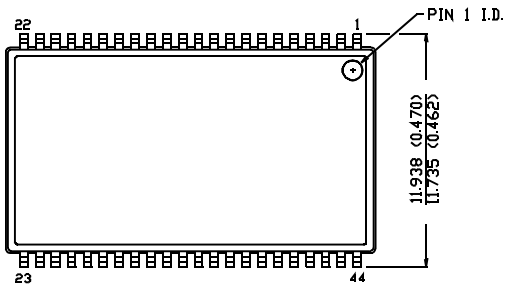

51-85090-*B

44-pin TSOP II Z44

 DIMENSION IN MM (INCH)
 MAX.
 MIN.

TOP VIEW

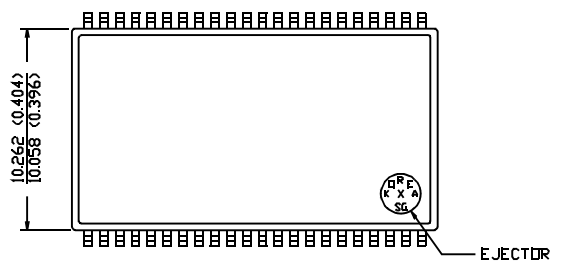

BOTTOM VIEW

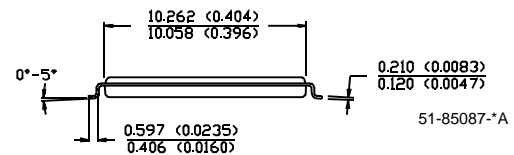
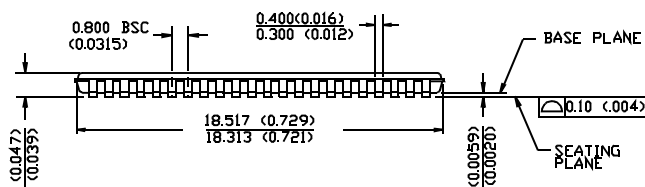

51-85087-*A

All product and company names mentioned in this document may be the trademarks of their respective holders.

Document History Page

Document Title: CY7C1049CV33 512K x 8 Static RAM				
Document Number: 38-05006				
REV.	ECN NO.	Issue Date	Orig. of Change	Description of Change
**	112569	03/06/02	HGK	New Data Sheet
*A	114091	04/25/02	DFP	Changed Tpower unit from ns to μ s
*B	116479	09/16/02	CEA	Add applications foot note to data sheet, page 1.