

512K (32K x 16) Static RAM

Features

- Pin- and function-compatible with CY7C1020V33
- Temperature Ranges
 - Commercial: 0°C to 70°C
 - Industrial: -40°C to 85°C
 - Automotive: -40°C to 125°C
- High speed
 - $t_{AA} = 10$ ns
- CMOS for optimum speed/power
- Low active power
 - 325 mW (max.)
- Automatic power-down when deselected
- Independent control of upper and lower bits
- Available in Pb-free and non Pb-free 44-pin TSOP II package

Functional Description

The CY7C1020CV33 is a high-performance CMOS static RAM organized as 32,768 words by 16 bits. This device has an automatic power-down feature that significantly reduces power consumption when deselected.

Writing to the device is accomplished by taking Chip Enable (CE) and Write Enable (WE) inputs LOW. If Byte Low Enable (BLE) is LOW, then data from I/O pins (I/O₁ through I/O₈), is written into the location specified on the address pins (A₀ through A₁₄). If Byte High Enable (BHE) is LOW, then data from I/O pins (I/O₉ through I/O₁₆) is written into the location specified on the address pins (A₀ through A₁₄).

Reading from the device is accomplished by taking Chip Enable (CE) and Output Enable (OE) LOW while forcing the Write Enable (WE) HIGH. If Byte Low Enable (BLE) is LOW, then data from the memory location specified by the address pins will appear on I/O₁ to I/O₈. If Byte High Enable (BHE) is LOW, then data from memory will appear on I/O₉ to I/O₁₆. See the truth table at the back of this data sheet for a complete description of read and write modes.

The input/output pins (I/O₁ through I/O₁₆) are placed in a high-impedance state when the device is deselected (CE HIGH), the outputs are disabled (OE HIGH), the BHE and BLE are disabled (BHE, BLE HIGH), or during a write operation (CE LOW, and WE LOW).

The CY7C1020CV33 is available in standard 44-pin TSOP Type II package.

Logic Block Diagram

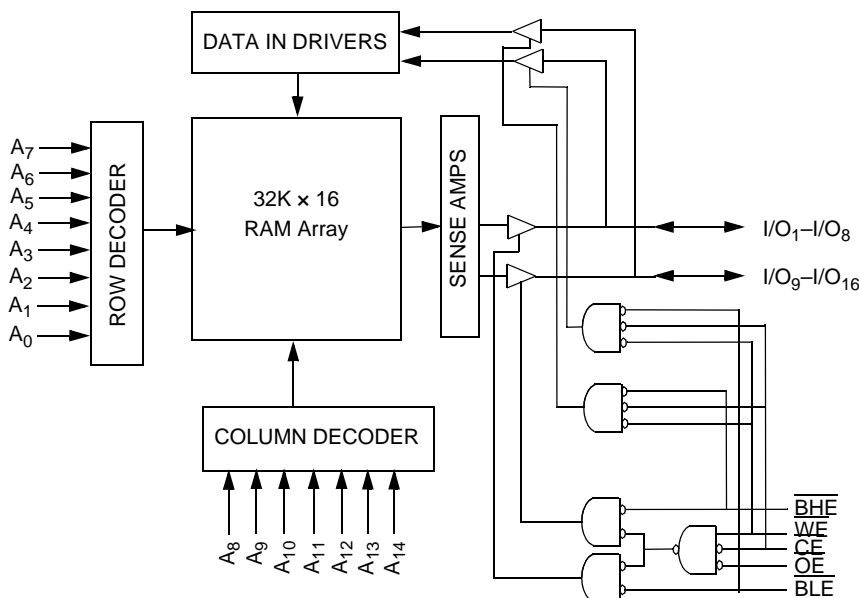

Pin Configuration^[1]

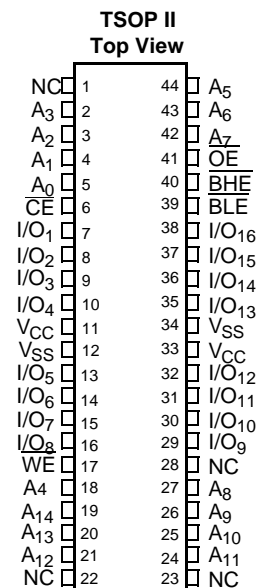

Note:

1. NC pins are not connected on the die

Selection Guide

		-10	-12	-15	Unit
Maximum Access Time		10	12	15	ns
Maximum Operating Current	Com'l/Ind'l	90	85	80	mA
	Automotive	-	-	85	mA
Maximum CMOS Standby Current	Com'l/Ind'l	5	5	5	mA
	Automotive	-	-	10	mA

Pin Definitions

Pin Name	TSOP - Pin Number	I/O Type	Description
A ₀ -A ₁₄	5, 4, 3, 2, 18, 44, 43, 42, 27, 26, 25, 24, 21, 20, 19	Input	Address Inputs used to select one of the address locations.
I/O ₁ -I/O ₁₆	7-10, 13-16, 29-32, 35-38	Input/Output	Bidirectional Data I/O lines. Used as input or output lines depending on operation.
NC	1, 22, 23, 28	No Connect	No Connects. Not connected to the die.
\overline{WE}	17	Input/Control	Write Enable Input, active LOW. When selected LOW, a Write is conducted. When deselected HIGH, a Read is conducted.
\overline{CE}	6	Input/Control	Chip Enable Input, active LOW. When LOW, selects the chip. When HIGH, deselects the chip.
\overline{BHE} , \overline{BLE}	40, 39	Input/Control	Byte Write Select Inputs, active LOW. \overline{BHE} controls I/O ₁₆ -I/O ₉ , \overline{BLE} controls I/O ₈ -I/O ₁ .
\overline{OE}	41	Input/Control	Output Enable, active LOW. Controls the direction of the I/O pins. When LOW, the I/O pins are allowed to behave as outputs. When deasserted HIGH, I/O pins are tri-stated, and act as input data pins.
V _{SS}	12, 34	Ground	Ground for the device. Should be connected to ground of the system.
V _{CC}	11, 33	Power Supply	Power Supply inputs to the device.

Maximum Ratings

(Above which the useful life may be impaired. For user guidelines, not tested.)

Storage Temperature -65°C to +150°C
 Ambient Temperature with Power Applied -55°C to +125°C
 Supply Voltage on V_{CC} to Relative GND^[1] -0.5V to +4.6V
 DC Voltage Applied to Outputs in High-Z State^[2] -0.5V to V_{CC} + 0.5V
 DC Input Voltage^[2] -0.5V to V_{CC} + 0.5V

Current into Outputs (LOW) 20 mA
 Static Discharge Voltage > 2001V (per MIL-STD-883, Method 3015)
 Latch-up Current > 200 mA

Operating Range

Range	Ambient Temperature	V _{CC}
Commercial	0°C to +70°C	3.3V ± 10%
Industrial	-40°C to +85°C	3.3V ± 10%
Automotive	-40°C to +125°C	3.3V ± 10%

Electrical Characteristics Over the Operating Range

Parameter	Description	Test Conditions	-10		-12		-15		Unit	
			Min.	Max.	Min.	Max.	Min.	Max.		
V _{OH}	Output HIGH Voltage	V _{CC} = Min., I _{OH} = -4.0 mA	2.4		2.4		2.4		V	
V _{OL}	Output LOW Voltage	V _{CC} = Min., I _{OL} = 8.0 mA		0.4		0.4		0.4	V	
V _{IH}	Input HIGH Voltage		2.0	V _{CC} + 0.3	2.0	V _{CC} + 0.3	2.0	V _{CC} + 0.3	V	
V _{IL}	Input LOW Voltage ^[2]		-0.3	0.8	-0.3	0.8	-0.3	0.8	V	
I _{IX}	Input Leakage Current	GND ≤ V _I ≤ V _{CC}	Com'l/Ind'l	-1	+1	-1	+1	-1	+1	μA
			Auto					-20	+20	μA
I _{OZ}	Output Leakage Current	GND ≤ V _I ≤ V _{CC} , Output Disabled	Com'l/Ind'l	-1	+1	-1	+1	-1	+1	μA
			Auto					-20	+20	μA
I _{CC}	V _{CC} Operating Supply Current	V _{CC} = Max., I _{OUT} = 0 mA, f = f _{MAX} = 1/t _{RC}	Com'l/Ind'l		90		85		80	mA
			Auto						85	mA
I _{SB1}	Automatic CE Power-down Current —TTL Inputs	Max. V _{CC} , CE ≥ V _{IH} , V _{IN} ≥ V _{IH} or V _{IN} ≤ V _{IL} , f = f _{MAX}	Com'l/Ind'l		15		15		15	mA
			Auto						20	mA
I _{SB2}	Automatic CE Power-down Current —CMOS Inputs	Max. V _{CC} , CE ≥ V _{CC} - 0.3V, V _{IN} ≥ V _{CC} - 0.3V, or V _{IN} ≤ 0.3V, f = 0	Com'l/Ind'l		5		5		5	mA
			Auto						10	mA

Capacitance^[3]

Parameter	Description	Test Conditions	Max.	Unit
C _{IN}	Input Capacitance	T _A = 25°C, f = 1 MHz, V _{CC} = 3.3V	8	pF
C _{OUT}	Output Capacitance		8	pF

Thermal Resistance^[3]

Parameter	Description	Test Conditions	44-pin TSOP-II	Unit
θ _{JA}	Thermal Resistance (Junction to Ambient)	Test conditions follow standard test methods and procedures for measuring thermal impedance, per EIA/JESD51.	76.92	°C/W
θ _{JC}	Thermal Resistance (Junction to Case)		15.86	°C/W

Notes:

- V_{IL} (min.) = -2.0V and V_{IH} (max) = V_{CC} + 0.5V for pulse durations of less than 20 ns.
- Tested initially and after any design or process changes that may affect these parameters.

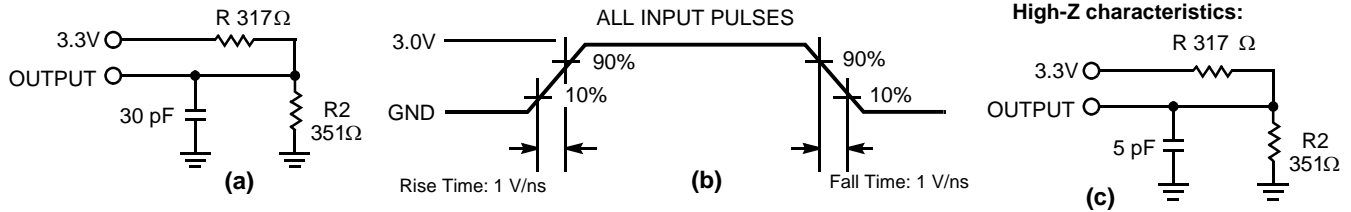
AC Test Loads and Waveforms^[4]

Switching Characteristics Over the Operating Range^[4]

Parameter	Description	-10		-12		-15		Unit
		Min.	Max.	Min.	Max.	Min.	Max.	
Read Cycle								
t_{RC}	Read Cycle Time	10		12		15		ns
t_{AA}	Address to Data Valid		10		12		15	ns
t_{OHA}	Data Hold from Address Change	3		3		3		ns
t_{ACE}	\overline{CE} LOW to Data Valid		10		12		15	ns
t_{DOE}	\overline{OE} LOW to Data Valid		5		6		7	ns
t_{LZOE}	\overline{OE} LOW to Low-Z ^[5]	0		0		0		ns
t_{HZOE}	\overline{OE} HIGH to High-Z ^[5, 6]		5		6		7	ns
t_{LZCE}	\overline{CE} LOW to Low-Z ^[5]	3		3		3		ns
t_{HZCE}	\overline{CE} HIGH to High-Z ^[5, 6]		5		6		7	ns
$t_{PU}^{[7]}$	\overline{CE} LOW to Power-up	0		0		0		ns
$t_{PD}^{[7]}$	\overline{CE} HIGH to Power-down		10		12		15	ns
t_{DBE}	Byte Enable to Data Valid		5		6		7	ns
t_{LZBE}	Byte Enable to Low-Z	0		0		0		ns
t_{HZBE}	Byte Disable to High-Z		5		6		7	ns
Write Cycle^[8]								
t_{WC}	Write Cycle Time	10		12		15		ns
t_{SCE}	\overline{CE} LOW to Write End	8		9		10		ns
t_{AW}	Address Set-up to Write End	7		8		10		ns
t_{HA}	Address Hold from Write End	0		0		0		ns
t_{SA}	Address Set-up to Write Start	0		0		0		ns
t_{PWE}	\overline{WE} Pulse Width	7		8		10		ns
t_{SD}	Data Set-up to Write End	5		6		8		ns
t_{HD}	Data Hold from Write End	0		0		0		ns
t_{LZWE}	\overline{WE} HIGH to Low-Z ^[5]	3		3		3		ns
t_{HZWE}	\overline{WE} LOW to High-Z ^[5, 6]		5		6		7	ns
t_{BW}	Byte Enable to End of Write	7		8		9		ns

Notes:

4. Test conditions assume signal transition time of 3 ns or less, timing reference levels of 1.5V, input pulse levels of 0 to 3.0V.
5. At any given temperature and voltage condition, t_{HZCE} is less than t_{LZCE} , t_{HZOE} is less than t_{LZOE} , and t_{HZWE} is less than t_{LZWE} for any given device.
6. t_{HZOE} , t_{HZBE} , t_{HZCE} , and t_{HZWE} are specified with a load capacitance of 5 pF as in part (c) of AC Test Loads. Transition is measured ± 500 mV from steady-state voltage.
7. This parameter is guaranteed by design and is not tested.
8. The internal Write time of the memory is defined by the overlap of \overline{CE} LOW, \overline{WE} LOW and $\overline{BHE}/\overline{BLE}$ LOW. \overline{CE} , \overline{WE} and $\overline{BHE}/\overline{BLE}$ must be LOW to initiate a Write, and the transition of these signals can terminate the Write. The input data set-up and hold timing should be referenced to the leading edge of the signal that terminates the Write.

Switching Waveforms

Read Cycle No. 1^[9, 10]

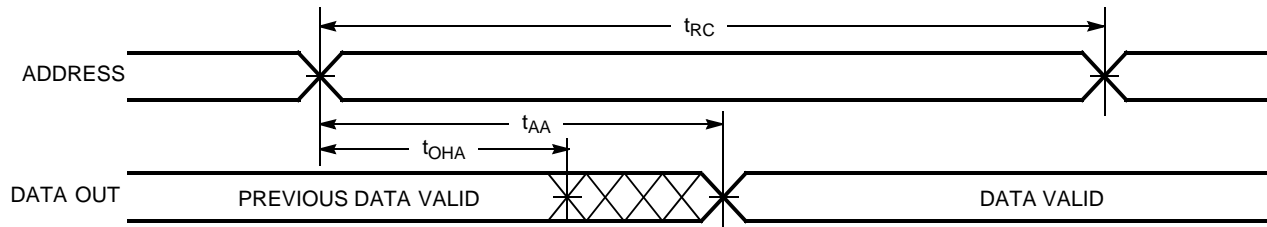

Read Cycle No. 2 (\overline{OE} Controlled)^[10, 11]

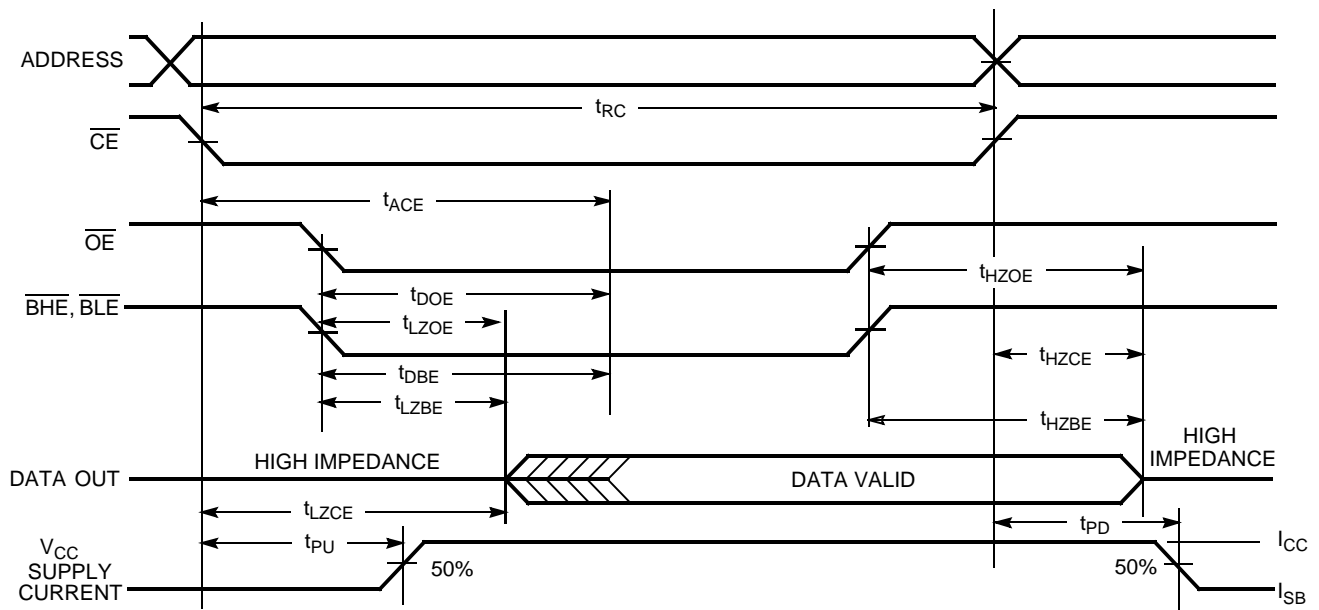

Notes:

- 9. Device is continuously selected. \overline{OE} , \overline{CE} , \overline{BHE} and/or \overline{BLE} = V_{IL} .
- 10. \overline{WE} is HIGH for Read cycle.
- 11. Address valid prior to or coincident with \overline{CE} transition LOW.

Switching Waveforms (continued)

Write Cycle No. 1 ($\overline{\text{CE}}$ Controlled)^[12, 13]

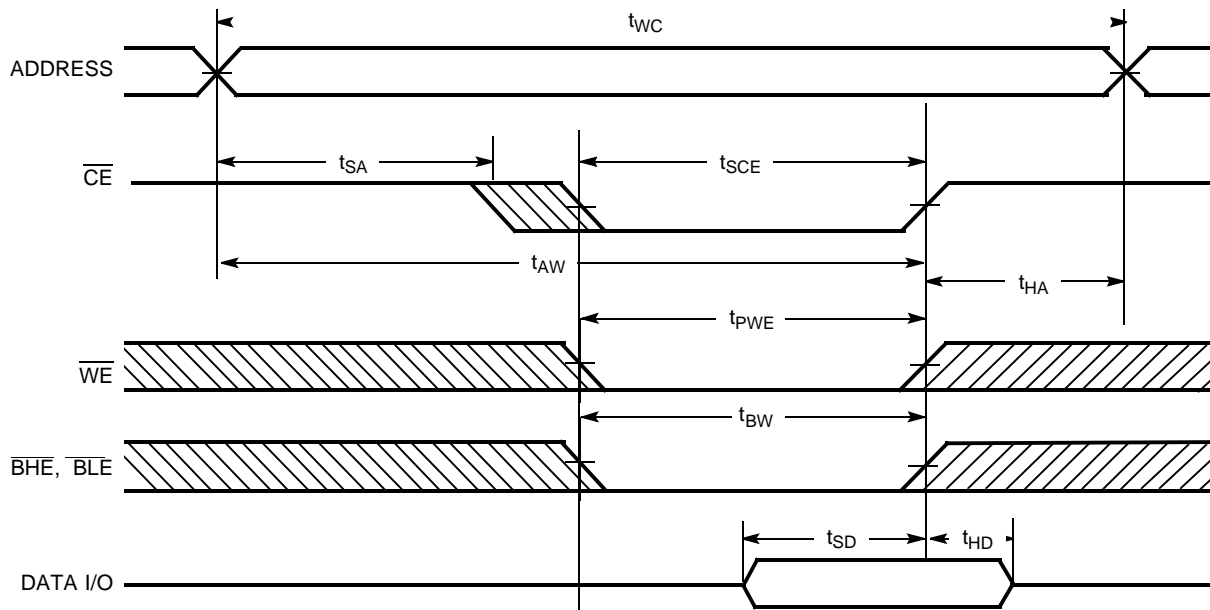

Write Cycle No. 2 ($\overline{\text{BLE}}$ or $\overline{\text{BHE}}$ Controlled)

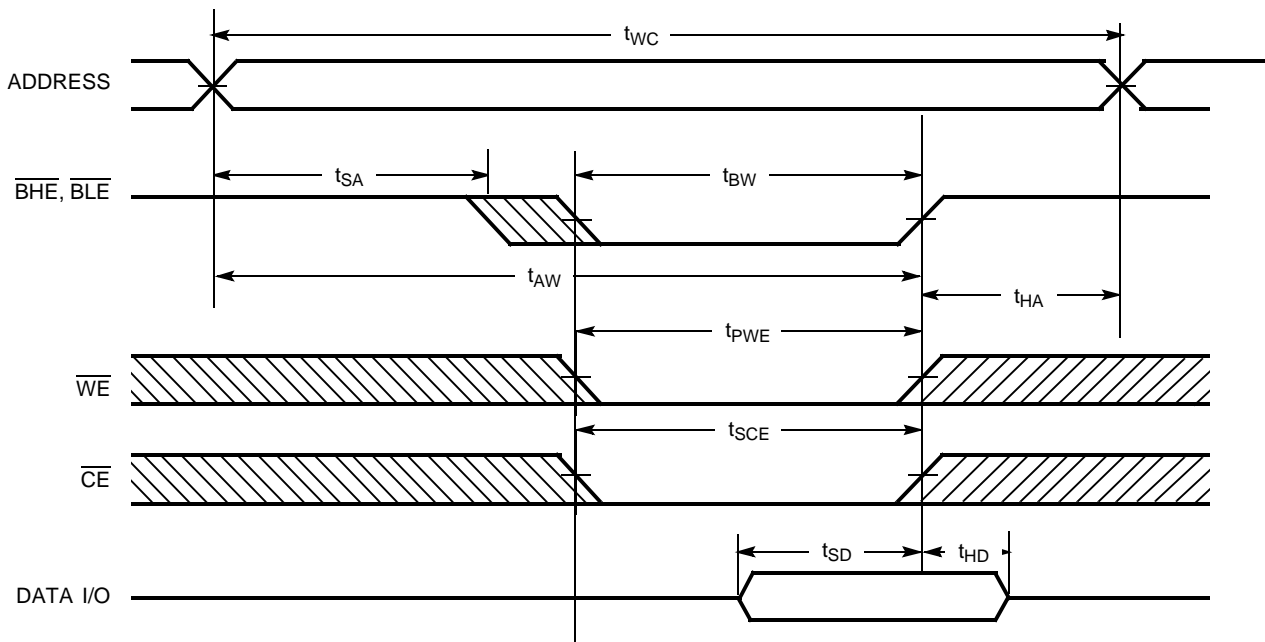

Notes:

- 12. Data I/O is high impedance if $\overline{\text{OE}}$ or $\overline{\text{BHE}}$ and/or $\overline{\text{BLE}} = V_{\text{IH}}$.
- 13. If $\overline{\text{CE}}$ goes HIGH simultaneously with $\overline{\text{WE}}$ going HIGH, the output remains in a high-impedance state.

Switching Waveforms (continued)

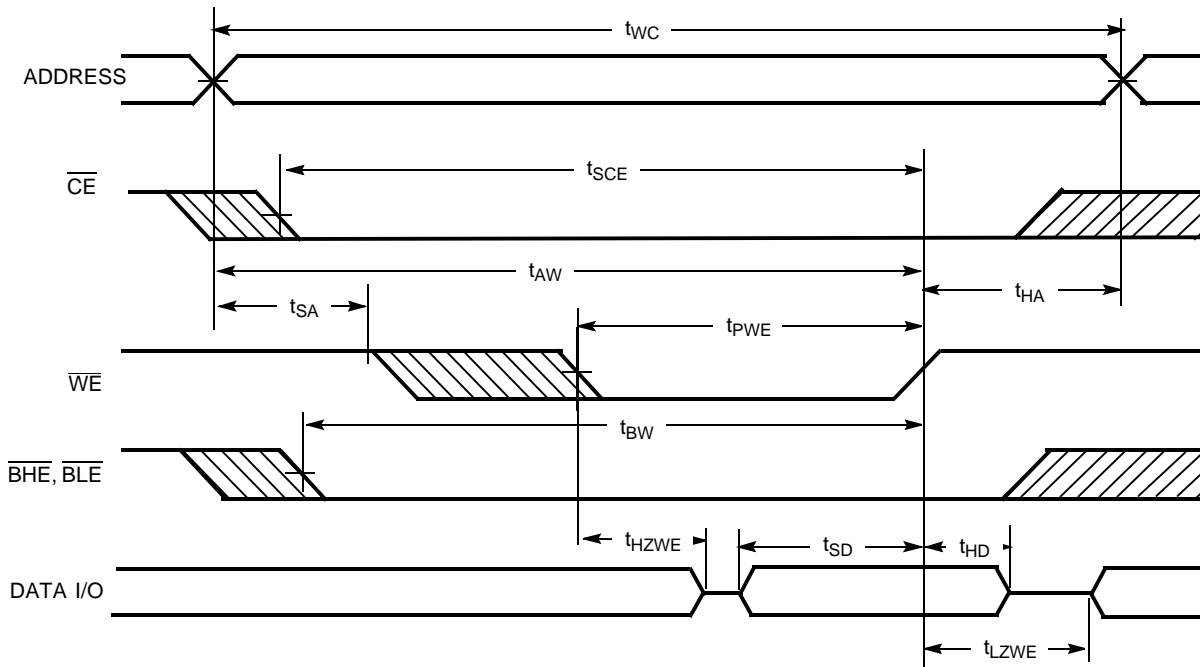
Write Cycle No. 3 (\overline{WE} Controlled, \overline{OE} LOW)

Truth Table

CE	OE	WE	BLE	BHE	I/O ₁ -I/O ₈	I/O ₉ -I/O ₁₆	Mode	Power
H	X	X	X	X	High-Z	High-Z	Power-down	Standby (I_{SB})
L	L	H	L	L	Data Out	Data Out	Read—All bits	Active (I_{CC})
			L	H	Data Out	High-Z	Read—Lower bits only	Active (I_{CC})
			H	L	High-Z	Data Out	Read—Upper bits only	Active (I_{CC})
L	X	L	L	L	Data In	Data In	Write—All bits	Active (I_{CC})
			L	H	Data In	High-Z	Write—Lower bits only	Active (I_{CC})
			H	L	High-Z	Data In	Write—Upper bits only	Active (I_{CC})
L	H	H	X	X	High-Z	High-Z	Selected, Outputs Disabled	Active (I_{CC})
L	X	X	H	H	High-Z	High-Z	Selected, Outputs Disabled	Active (I_{CC})

Ordering Information

Speed (ns)	Ordering Code	Package Diagram	Package Type	Operating Range
10	CY7C1020CV33-10ZC	51-85087	44-pin TSOP Type II	Commercial
	CY7C1020CV33-10ZXC		44-pin TSOP Type II (Pb-Free)	
12	CY7C1020CV33-12ZC		44-pin TSOP Type II	Commercial
15	CY7C1020CV33-15ZC		44-pin TSOP Type II	Commercial
	CY7C1020CV33-15ZE		44-pin TSOP Type II	
	CY7C1020CV33-15ZSXE		44-pin TSOP Type II (Pb-Free)	

Package Diagrams

44-Pin TSOP II (51-85087)

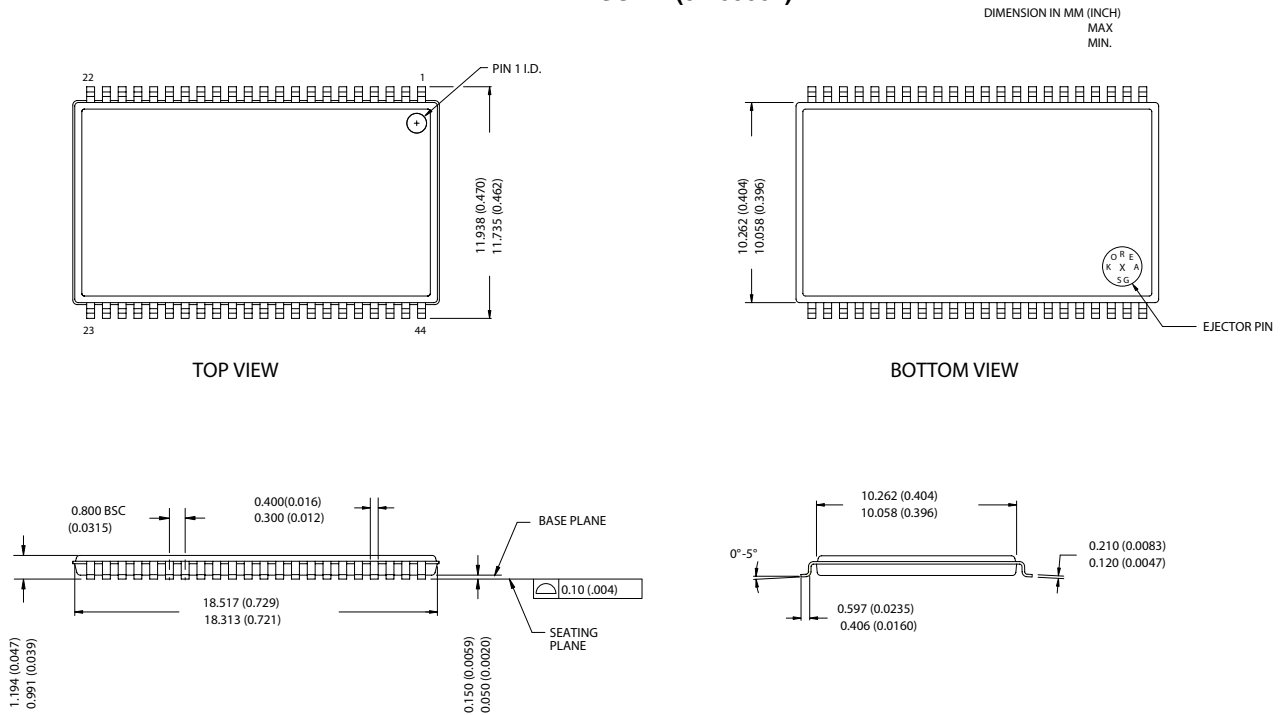

51-85087-*A

All products and company names mentioned in this document may be the trademarks of their respective holders.

Document History Page

Document Title: CY7C1020CV33 512K (32K x 16) Static RAM				
Document Number: 38-05133				
REV.	ECN NO.	Issue Date	Orig. of Change	Description of Change
**	109428	12/16/01	HGK	New Data Sheet
*A	115045	05/30/02	HGK	I _{CC} and I _{SB1} data modified
*B	117615	08/14/02	DFP	Pin 1= NC Pin 18 = A4; remove SOJ package option; remove 8ns option.
*C	262949	See ECN	RKF	Added Automotive Specs to Data sheet
*D	334398	See ECN	SYT	Added Lead-Free Product Information
*E	493543	See ECN	NXR	Added note #1 on page #1 Changed the description of I _{Ix} from Input Load Current to Input Leakage Current in DC Electrical Characteristics table Removed I _{OS} parameter from DC Electrical Characteristics table Updated Ordering Information Table