

# FailSafe™ PacketClock™ Global Communications Clock Generator

## Features

- Fully integrated phase-locked loop (PLL)
- FailSafe™ output
- PLL driven by a crystal oscillator that is phase aligned with external reference
- 100-MHz output from 10-MHz input
- Low-jitter, high-accuracy outputs
- 3.3V ± 5% operation
- 16-lead TSSOP

## Benefits

- Integrated high-performance PLL tailored for telecommunications frequency synthesis eliminates the need for external loop filter components
- When reference is off, DCXO maintains clock outputs and SAFE pin indicates FailSafe conditions
- DCXO maintains continuous operation should the input reference clock fail
- Glitch-free transition simplifies system design
- Works with commonly available, low-cost 10-MHz crystal
- Zero-ppm error for all output frequencies
- Compatible across industry standard design platforms
- Industry standard package with 6.4 × 5.0 mm<sup>2</sup> footprint and a height profile of just 1.1 mm

## Logic Block Diagram

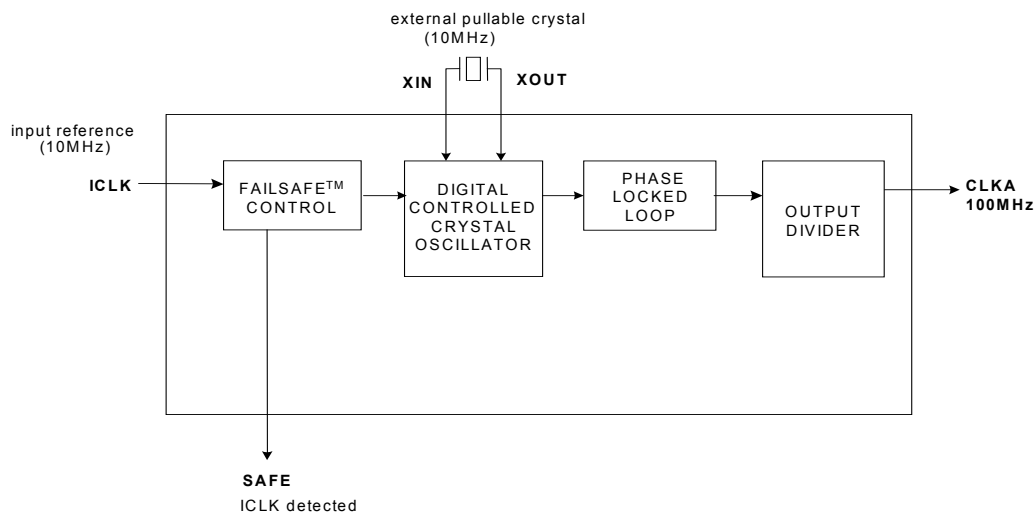

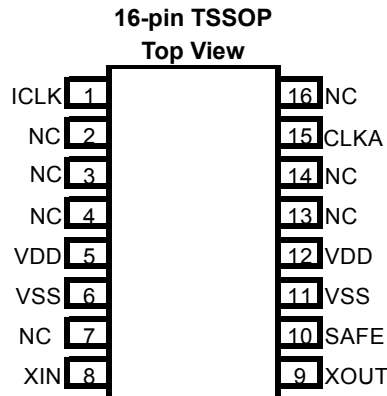
**Pin Configuration**

**Pin Description**

Pin Number	Pin Name	Pin Description
1	ICLK	Reference Input Clock; 10 MHz.
2	NC	No Connect.
3	NC	No Connect.
4	NC	No Connect.
5	VDD	Voltage Supply; 3.3V.
6	VSS	Ground.
7	NC	No Connect
8	XIN	Pullable Crystal Input; 10 MHz.
9	XOUT	Pullable Crystal Output; 10 MHz.
10	SAFE	High = reference ICLK within range, Low = reference ICLK out of range.
11	VSS	Ground.
12	VDD	Voltage Supply; 3.3V.
13	NC	No Connect.
14	NC	No Connect.
15	CLKA	Clock Output. 100 MHz
16	NC	No Connect.

**Selector Guide**

Part Number	Input Frequency Range	Outputs	Output Frequencies
CY26049ZXC-22	Reference Input Clock: 10 MHz Crystal: 10-MHz pullable Crystal per Cypress Specification	1	100 MHz

**Description**

CY26049-22 is a FailSafe™ frequency synthesizer with a reference clock input and 100-MHz output. The device provides an optimum solution for applications where continuous operation is required in the event of a primary clock failure. The continuous, glitch-free operation is achieved by using a DCXO, which serves as a primary clock source. The FailSafe control circuit synchronizes the DCXO oscillator with the reference as long as the reference is within the pull range of the crystal.

In the event of a reference clock failure the DCXO maintains the last frequency of the reference clock. The unique feature of the CY26049-22 is that the DCXO is, in fact, the primary clocking source. When the reference clock is restored, the DCXO automatically resynchronizes to the reference. The status of the reference clock input, as detected by the CY26049-22, is reported by the SAFE pin.

**Absolute Maximum Conditions**

Supply Voltage ( $V_{DD}$ ) ..... -0.5 to +7.0V  
 DC Input Voltage ..... -0.5V to  $V_{DD} + 0.5$   
 Storage Temperature (Non-Condensing) ..... -55°C to +125°C  
 Junction Temperature ..... -40°C to +125°C

Data Retention @  $T_j = 125^\circ\text{C}$  ..... >10 Years  
 Package Power Dissipation ..... 350 mW  
 ESD (Human Body Model) MIL-STD-883 ..... 2000V  
 (Above which the useful life may be impaired. For user guidelines, not tested.)

**Recommended Pullable Crystal Specifications**

Parameter	Name	Comments	Min.	Typ.	Max.	Unit
$F_{NOM}$	Nominal crystal frequency	Parallel resonance, fundamental mode, AT cut	-	10	-	MHz
$C_{LNOM}$	Nominal load capacitance		-	14	-	pF
$R_1$	Equivalent series resistance (ESR)	Fundamental mode	-	-	25	$\Omega$
$R_3/R_1$	Ratio of third overtone mode ESR to fundamental mode ESR	Ratio used because typical $R_1$ values are much less than the maximum spec	3	-	-	
DL	Crystal drive level	No external series resistor assumed	-	0.5	2	mW
$F_{3SEPLI}$	Third overtone separation from $3 \cdot F_{NOM}$	High side	400	-	-	ppm
$F_{3SEPLO}$	Third overtone separation from $3 \cdot F_{NOM}$	Low side	-	-	-200	ppm
$C_0$	Crystal shunt capacitance		-	-	7	pF
$C_0/C_1$	Ratio of shunt to motional capacitance		180	-	250	
$C_1$	Crystal motional capacitance		14.4	18	21.6	fF

**Recommended Operating Conditions**

Parameter	Description	Min.	Typ.	Max.	Unit
$V_{DD}$	Operating Voltage	3.15	3.3	3.45	V
$T_{AC}$	Ambient Temperature (Commercial Temperature)	0	-	70	$^\circ\text{C}$
$C_{LOAD}$	Max Output Load Capacitance	-	-	15	pF
$t_{pu}$	Power-up time for all $V_{DD}$ s to reach minimum specified voltage (power ramps must be monotonic)	0.05	-	500	ms

**DC Electrical Specifications** (Commercial Temp: 0° to 70°C)

Parameter	Description	Test Conditions	Min.	Typ.	Max.	Unit
$I_{OH}$	Output High Current	$V_{OH} = V_{DD} - 0.5$ , $V_{DD} = 3.3\text{V}$ (source)	12	24	-	mA
$I_{OL}$	Output Low Current	$V_{OL} = 0.5$ , $V_{DD} = 3.3\text{V}$ (sink)	12	24	-	mA
$V_{IH}$	Input High Voltage	CMOS Levels	0.7	-	-	$V_{DD}$
$V_{IL}$	Input High Voltage	CMOS Levels	-	-	0.3	$V_{DD}$
$I_{IH}$	Input High Current	$V_{IH} = V_{DD}$	-	5	10	$\mu\text{A}$
$I_{IL}$	Input Low Current	$V_{IL} = 0\text{V}$	-	5	10	$\mu\text{A}$
$C_{IN}$	Input Capacitance		-	-	7	pF
$I_{DD}$	Supply Current	$C_{LOAD} = 15\text{ pF}$ , $V_{DD} = 3.45\text{V}$	-	-	45	mA

**AC Electrical Specifications** (Commercial Temp: 0° to 70°C)

Parameter	Description	Test Conditions	Min.	Typ.	Max.	Unit
$f_{ICLK-E}$	Frequency, Input Clock	Input Clock Frequency, External Mode	-	10	-	MHz
LR	FailSafe Lock Range <sup>[1]</sup>	Range of reference ICLK for Safe = High	-250	-	+250	ppm
$DC = t_2/t_1$	Output Duty Cycle	Duty Cycle defined in <i>Figure 1</i> , measured at 50% of $V_{DD}$	45	50	55	%
$T_{PJIT1}$	Clock Jitter	Period Jitter, Peak to Peak, 10,000 periods	-	-	250	ps
		RMS Period Jitter	-	-	50	ps

**Note:**

1. Dependent on crystals chosen and crystal specs.

**AC Electrical Specifications** (Commercial Temp: 0° to 70°C) (continued)

Parameter	Description	Test Conditions	Min.	Typ.	Max.	Unit
$t_6$	PLL Lock Time	Time for PLL to lock within $\pm 150$ ppm of target frequency	–	–	3	ms
$t_{fs\_lock}$	FailSafe Lock Time	Time for PLL to lock to ICLK (outputs phase aligned with ICLK and Safe = High)	–	–	7	s
$f_{error}$	Frequency Synthesis Error	Actual mean frequency error vs. target	–	0	–	ppm
ER	Rising Edge Rate	Output Clock Edge Rate, Measured from 20% to 80% of $V_{DD}$ , $C_{LOAD} = 15$ pF. See Figure 2.	0.8	1.4	2	V/ns
EF	Falling Edge Rate	Output Clock Edge Rate, Measured from 20% to 80% of $V_{DD}$ , $C_{LOAD} = 15$ pF. See Figure 2.	0.8	1.4	2	V/ns

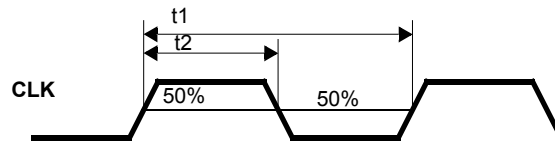
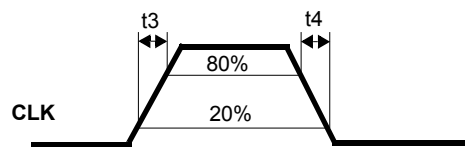
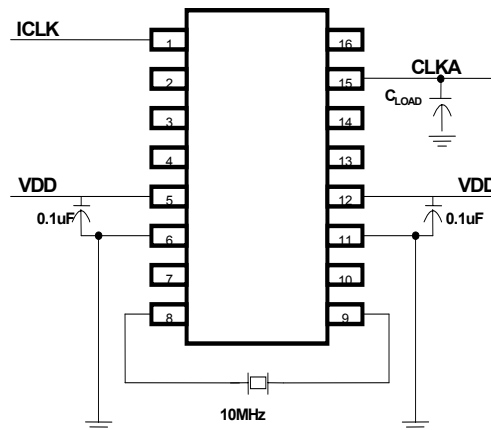
**Voltage and Timing Definitions**

**Figure 1. Duty Cycle Definition; DC =  $t_2/t_1$** 

**Figure 2. Rise and Fall Time Definitions: ER =  $0.6 \times V_{DD} / t_3$ , EF =  $0.6 \times V_{DD} / t_4$** 
**Test Circuit**

**Ordering Information**

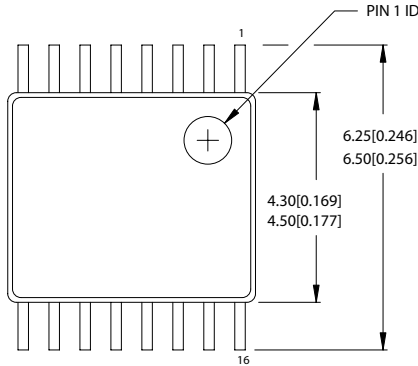
Ordering Code	Package Type	Operating Temperature Range
<b>Lead-Free</b>		
CY26049ZXC-22	16-lead TSSOP	Commercial 0° to 70°C
CY26049ZXC-22T	16-lead TSSOP—Tape and Reel	Commercial 0° to 70°C

Package Drawing and Dimensions

16-lead TSSOP 4.40 MM Body Z16.173



DIMENSIONS IN MM[INCHES] MIN.

MAX.

REFERENCE JEDEC MO-153

PACKAGE WEIGHT 0.05gms

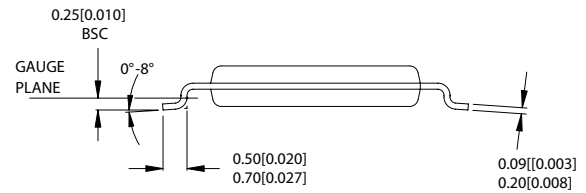
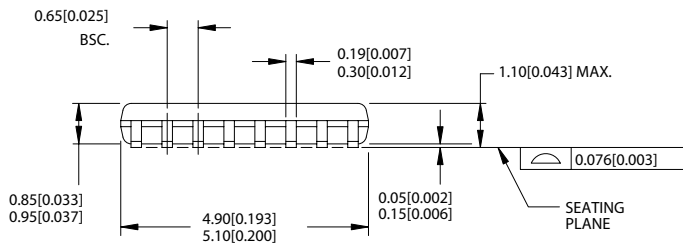

51-85091-A

FailSafe and PacketClock are trademarks of Cypress Semiconductor Corporation. All product and company names mentioned in this document are the trademarks of their respective holders.

**Document History Page**

<b>Document Title: CY26049-22 FailSafe™ PacketClock™ Global Communications Clock Generator</b> <b>Document Number: 38-07730</b>				
<b>REV.</b>	<b>ECN No.</b>	<b>Issue Date</b>	<b>Orig. of Change</b>	<b>Description of Change</b>
**	308456	See ECN	RGL	New Data Sheet