

## Three PLL Programmable Clock Generator with Spread Spectrum

### Features

- Three fully integrated phase locked loops (PLLs)
- Input frequency range
  - External crystal: 8 to 48 MHz
  - External reference: 8 to 166 MHz clock
- Reference Clock input voltage range
  - 2.5V, 3.0V, and 3.3V for CY25483
  - 1.8V for CY25403 and CY25423
- Wide operating output frequency range
  - 3 to 166 MHz
- Programmable Spread Spectrum with Center and Down Spread option and Lexmark and Linear modulation profiles
- VDD supply voltage options:
  - 2.5V, 3.0V, and 3.3V for CY25403 and CY25483
  - 1.8V for CY25423
- Selectable output clock voltages independent of VDD supply:
  - 2.5V, 3.0V, and 3.3V for CY25403 and CY25483
  - 1.8V for CY25423
- Frequency Select feature with option to select four different frequencies
- Power Down, Output Enable, and SS ON/OFF controls
- Low jitter, high accuracy outputs
- Ability to synthesize nonstandard frequencies with Fractional-N capability

- Three clock outputs with Programmable drive strength
- Glitch-free outputs while frequency switching
- 8-pin SOIC package
- Commercial and Industrial temperature ranges

### Benefits

- Multiple high performance PLLs allow synthesis of unrelated frequencies
- Nonvolatile programming for personalization of PLL frequencies, spread spectrum characteristics, drive strength, crystal load capacitance, and output frequencies
- Application specific Programmable EMI reduction using Spread Spectrum for clocks
- Programmable PLLs for system frequency margin tests
- Meets critical timing requirements in complex system designs
- Suitability for PC, consumer, portable, and networking applications
- Capable of Zero PPM frequency synthesis error
- Uninterrupted system operation during clock frequency switch
- Application compatibility in standard and low power systems

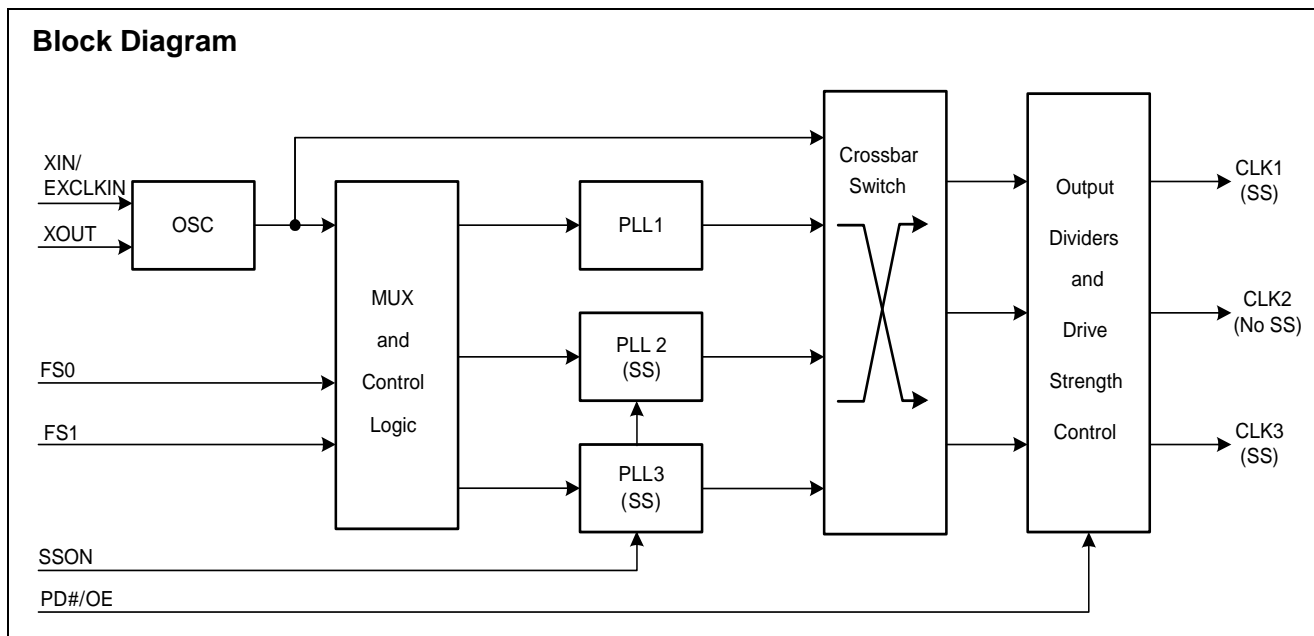

**Table 1. Device Selector Guide**

Device	Crystal Input	EXCKLKIN Input	VDD
CY25403	Yes	1.8V LVCMOS	2.5V, 3.0V, 3.3V
CY25483	No	2.5V, 3.0V, 3.3V LVCMOS	2.5V, 3.0V, 3.3V
CY25423	Yes	1.8V LVCMOS	1.8V

**Figure 1. Pin Diagram - CY25403 8-LD SOIC**

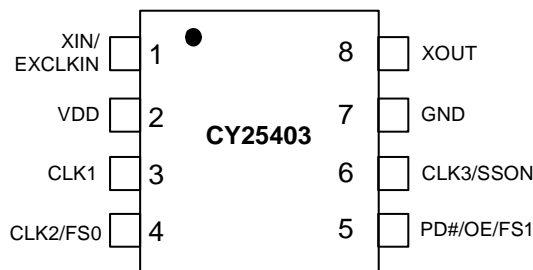

**Table 1. Pin Definition - CY25403 (2.5V, 3.0V or 3.3V Supply)**

Pin Number	Name	IO	Description
1	XIN/EXCLKIN	Input	Crystal Input or 1.8V External Clock Input
2	VDD	Power	Power Supply: 2.5V, 3.0V or 3.3V
3	CLK1	Output	Programmable Clock Output with Spread Spectrum
4	CLK2/FS0	Output/Input	Multifunction Programmable pin: Programmable Clock Output with no Spread Spectrum or Frequency Select pin
5	PD#/OE/FS1	Input	Multifunction Programmable pin: Power Down, Output Enable or Frequency Select pin
6	CLK3/SSON	Output/Input	Multifunction Programmable pin: Programmable Clock Output with Spread Spectrum or Spread Spectrum ON/OFF control pin
7	GND	Power	Power Supply Ground
8	XOUT	Output	Crystal Output

Figure 2. Pin Diagram - CY25483 8-LD SOIC

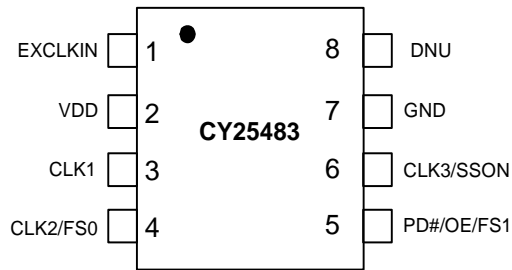

Table 2. Pin Definition - CY25483 (2.5V, 3.0V or 3.3V Supply)

Pin Number	Name	IO	Description
1	EXCLKIN	Input	2.5V, 3.0V or 3.3V External Clock Input
2	VDD	Power	Power Supply: 2.5V, 3.0V or 3.3V
3	CLK1	Output	Programmable Clock Output with Spread Spectrum
4	CLK2/FS0	Output/Input	Multifunction Programmable pin: Programmable Clock Output with no Spread Spectrum or Frequency Select pin
5	PD#/OE/FS1	Input	Multifunction Programmable pin: Power Down, Output Enable or Frequency Select pin
6	CLK3/SSON	Output/Input	Multifunction Programmable pin: Programmable Clock Output with Spread Spectrum or Spread Spectrum ON/OFF control pin
7	GND	Power	Power Supply Ground
8	DNU	Output	Do not use this pin

Figure 3. Pin Diagram - CY25423 8-LD SOIC

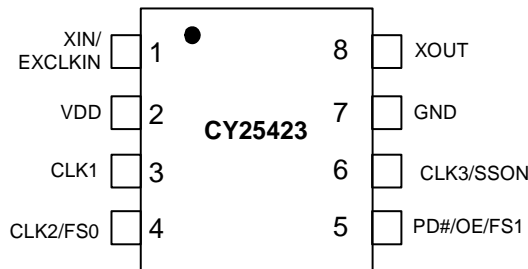

Table 3. Pin Definition - CY25423 (1.8V Supply)

Pin Number	Name	IO	Description
1	XIN/EXCLKIN	Input	Crystal Input or 1.8V External Clock Input
2	VDD	Power	Power Supply: 1.8V
3	CLK1	Output	Programmable Clock Output with Spread Spectrum
4	CLK2/FS0	Output/Input	Multifunction Programmable pin: Programmable Clock Output with no Spread Spectrum or Frequency Select pin
5	PD#/OE/FS1	Input	Multifunction Programmable pin: Power Down, Output Enable or Frequency Select pin
6	CLK3/SSON	Output/Input	Multifunction Programmable pin: Programmable Clock Output with Spread Spectrum or Spread Spectrum ON/OFF control pin
7	GND	Power	Power Supply Ground
8	XOUT	Output	Crystal Output

## General Description

### 3 Configurable PLLs

The CY25403, CY25483 and CY25423 have three programmable PLLs that can be used to generate output frequencies ranging from 3 to 166 MHz. The advantage of having three PLLs is that a single device generates up to three independent frequencies from a single crystal.

### Input Reference Clocks

The input reference clock can be either a crystal or a clock signal, for CY25403 and CY25423 while just a clock signal for CY25483. The input frequency range for crystal (XIN) is 8 MHz to 48 MHz and that for external reference clock (EXCLKIN) is 8 MHz to 166 MHz. The voltage range of the reference clock input for CY25483 is 2.5V/3.0V/3.3V while that for CY25403 and CY25423 is 1.8V. This gives user an option for this device to be compatible for different input clock voltage levels in the system.

### VDD Power Supply Options

These devices have programmable power supply options. The CY25403/CY25483 is a high voltage part that can be programmed to operate at any voltage 2.5V, 3.0V, or 3.3V while CY25423 is a low voltage part that can operate at 1.8V.

### Output Source Selection

These devices have programmable input sources for each of its clock outputs. There are four available clock sources and these clock sources are: XIN/EXCLKIN, PLL1, PLL2, and PLL3. Output clock source selection is done by using four out of four crossbar switch. Thus, any one of these four available clock sources can be arbitrarily selected for the clock outputs. This gives user a flexibility to have up to three independent clock outputs.

### Spread Spectrum Control

Two of the three PLLs (PLL2 and PLL3) have spread spectrum capability for EMI reduction in the system. The device uses a Cypress proprietary PLL and Spread Spectrum Clock (SSC) technology to synthesize and modulate the frequency of the PLL. The spread spectrum feature can be turned on or off using a multifunction control pin (CLK3/SSON). It can be programmed to either center spread range from  $\pm 0.125\%$  to  $\pm 2.50\%$  or down spread range from  $-0.25\%$  to  $-5.0\%$  with Lexmark or Linear profile.

### Frequency Select

Each PLL can be programmed for up to four different frequencies. There are two multifunction programmable pins,

CLK2/FS0 and PD#/OE/FS1 which if programmed as frequency select inputs, can be used to select among these arbitrarily programmed frequency settings. Each output has programmable output divider options.

### Glitch-Free Frequency Switch

When the frequency select pin, FS(1:0) is used to switch frequency, the outputs are glitch-free provided frequency is switched using output dividers. This feature enables uninterrupted system operation while clock frequency is being switched.

### PD#/OE Mode

Multifunction pin PD#/OE/FS1 (Pin 5) can be programmed to operate as either frequency select (FS1), power down (PD#) or output enable (OE) mode. PD# is a low-true input. If activated it shuts off the entire chip, resulting in minimum power consumption for the device. Setting this signal high brings the device in the operational mode with default register settings.

When this pin is programmed as Output Enable (OE), clock outputs can be enabled or disabled using OE (pin 5). Individual clock outputs can be programmed to be sensitive to this OE pin.

### Output Drive Strength

The DC drive strength of the individual clock output can be programmed for different values. Table 4 shows the typical rise and fall times for different drive strength settings.

Table 4. Output Drive Strength

Output Drive Strength	Rise/Fall Time (ns) (Typical Value)
Low	6.8
Mid Low	3.4
Mid High	2.0
High	1.0

### Generic Configuration and Custom Frequency

There is a generic set of output frequencies available from the factory that can be used for the device evaluation purposes. The device, CY25403, CY25483 and CY25423 can be custom programmed to any desired frequencies and listed features. For customer specific programming, please contact local Cypress Field Application Engineer (FAE) or sales representative.

**Absolute Maximum Conditions**

Parameter	Description	Condition	Min	Max	Unit
V <sub>DD</sub>	Supply Voltage for CY25403/CY25483		-0.5	4.5	V
V <sub>DD</sub>	Supply Voltage for CY25423		-0.5	2.6	V
V <sub>IN</sub>	Input Voltage for CY25403/CY25483	Relative to V <sub>SS</sub>	-0.5	V <sub>DD</sub> +0.5	V
V <sub>IN</sub>	Input Voltage for CY25423	Relative to V <sub>SS</sub>	-0.5	2.2	V
T <sub>S</sub>	Temperature, Storage	Non Functional	-65	+150	°C
ESD <sub>HBM</sub>	ESD Protection (Human Body Model)	JEDEC EIA/JESD22-A114-E	2000		Volts
UL-94	Flammability Rating	V-0 @ 1/8 in.		10	ppm
MSL	Moisture Sensitivity Level	SOIC package		3	

**Recommended Operating Conditions**

Parameter	Description	Min	Typ	Max	Unit
V <sub>DD</sub>	VDD Operating Voltage for CY25403	2.25	-	3.60	V
V <sub>DD</sub>	VDD Operating Voltage for CY25423	1.65	1.8	1.95	V
T <sub>AC</sub>	Commercial Ambient Temperature	0	-	+70	°C
T <sub>AI</sub>	Industrial Ambient Temperature	-40	--	+85	°C
C <sub>LOAD</sub>	Maximum Load Capacitance	-	-	15	pF
t <sub>PU</sub>	Power up time for all V <sub>DD</sub> to reach minimum specified voltage (power ramps must be monotonic)	0.05	-	500	ms

**Notes**

1. Guaranteed by design but not 100% tested.
2. Configuration dependent.

**DC Electrical Specifications**

Parameter	Description	Conditions	Min	Typ	Max	Unit
V <sub>OL</sub>	Output Low Voltage	I <sub>OL</sub> = 2 mA, drive strength = [00]	-	-	0.4	V
		I <sub>OL</sub> = 3 mA, drive strength = [01]				
		I <sub>OL</sub> = 7 mA, drive strength = [10]				
		I <sub>OL</sub> = 12 mA, drive strength = [11]				
V <sub>OH</sub>	Output High Voltage	I <sub>OH</sub> = -2 mA, drive strength = [00]	V <sub>DD</sub> - 0.4	-	-	V
		I <sub>OH</sub> = -3 mA, drive strength = [01]				
		I <sub>OH</sub> = -7 mA, drive strength = [10]				
		I <sub>OH</sub> = -12 mA, drive strength = [11]				
V <sub>IL1</sub>	Input Low Voltage of PD#/OE, FS0, FS1 and SSON		-	-	0.2*V <sub>DD</sub>	V
V <sub>IL2</sub>	Input Low Voltage of EXCLKIN		-	-	0.18	V
V <sub>IH1</sub>	Input High Voltage of PD#/OE, FS0, FS1 and SSON		0.8*V <sub>DD</sub>	-	-	V
V <sub>IH2</sub>	Input High Voltage of EXCLKIN for CY25403/CY25423		1.62	-	2.2	V
V <sub>IH3</sub>	Input High Voltage of EXCLKIN for CY25483		0.8*V <sub>DD</sub>	-	-	V
I <sub>IL</sub>	Input Low Current, PD#/OE/FS1	V <sub>IN</sub> = 0V	-	-	10	μA
I <sub>IH</sub>	Input High Current, PD#/OE/FS1	V <sub>IN</sub> = V <sub>DD</sub>	-	-	10	μA
I <sub>ILDN</sub>	Input Low Current, SSON and FS0 pins	V <sub>IN</sub> = 0V (Internal pull down resistor = 160k typ.)	-	-	10	μA
I <sub>IHDN</sub>	Input High Current, SSON and FS0 pins	V <sub>IN</sub> = V <sub>DD</sub> (Internal pull down resistor = 160k typ.)	14	-	36	μA
R <sub>DN</sub>	Pull Down Resistor of CLK1, CLK2/FS0 and CLK3/SSON pins	Output clocks in off state by setting PD# = Low	100	160	250	kΩ
I <sub>DD</sub> <sup>[1,2]</sup>	Supply Current for CY25423	PD# = High, No load	-	20	-	mA
	Supply Current for CY25403/CY25483	PD# = High, No load	-	22	-	mA
I <sub>DDS</sub> <sup>[1]</sup>	Standby Current	PD# = Low	-	3	-	μA
C <sub>IN</sub> <sup>[1]</sup>	Input Capacitance	SSON, PD#/OE/FS1 and FS0 pins	-	-	7	pF

## AC Electrical Specifications

Parameter	Description	Conditions	Min	Typ	Max	Unit
F <sub>IN</sub> (crystal)	Crystal Frequency, XIN		8	–	48	MHz
F <sub>IN</sub> (clock)	Input Clock Frequency (EXCLKIN)		8	–	166	MHz
F <sub>CLK</sub>	Output Clock Frequency		3	–	166	MHz
DC	Output Duty Cycle, All Clocks except Ref Out	Duty Cycle is defined in <a href="#">Figure 5 on page 8</a> ; t <sub>1</sub> /t <sub>2</sub> , measured at 50% of V <sub>DD</sub>	45	50	55	%
DC	Ref Out Duty Cycle	Ref In Min 45%, Max 55%	40	–	60	%
T <sub>RF1</sub> <sup>[1]</sup>	Output Rise/Fall Time	Measured from 20% to 80% of V <sub>DD</sub> , as shown in <a href="#">Figure 6 on page 8</a> , CL = 15 pF, drive strength [00]	–	6.8	–	ns
T <sub>RF2</sub> <sup>[1]</sup>	Output Rise/Fall Time	Measured from 20% to 80% of V <sub>DD</sub> , as shown in <a href="#">Figure 6 on page 8</a> , CL = 15 pF, drive strength [01]	–	3.4	–	ns
T <sub>RF3</sub> <sup>[1]</sup>	Output Rise/Fall Time	Measured from 20% to 80% of V <sub>DD</sub> , as shown in <a href="#">Figure 6 on page 8</a> , CL = 15 pF, drive strength [10]	–	2.0	–	ns
T <sub>RF4</sub> <sup>[1]</sup>	Output Rise/Fall Time	Measured from 20% to 80% of V <sub>DD</sub> , as shown in <a href="#">Figure 6 on page 8</a> , CL = 15 pF, drive strength [11]	–	1.0	–	ns
T <sub>CCJ</sub> <sup>[1,2]</sup>	Cycle-to-cycle Jitter (peak)	Configuration dependent. See <a href="#">Table 5</a>	–	100	–	ps
T <sub>LOCK</sub> <sup>[1]</sup>	PLL Lock Time	Measured from 90% of the applied power supply level	–	1	3	ms

**Table 5. Configuration Example for C-C Jitter**

Ref. Frequency (MHz)	CLK1 Output		CLK2 Output		CLK3 Output	
	Freq. (MHz)	C-C Jitter Typ (ps)	Freq. (MHz)	C-C Jitter Typ (ps)	Freq. (MHz)	C-C Jitter Typ (ps)
14.3181	8.0	134	166	103	48	92
19.2	74.25	99	166	94	8	91
27	48	67	27	109	166	103
48	48	93	27	123	166	137

## Recommended Crystal Specification for SMD Package

Parameter	Description	Range 1	Range 2	Range 3	Unit
Fmin	Minimum Frequency	8	14	28	MHz
Fmax	Maximum Frequency	14	28	48	MHz
R1	Motional Resistance (ESR)	135	50	30	Ω
C0	Shunt Capacitance	4	4	2	pF
CL	Parallel Load Capacitance	18	14	12	pF
DL(max)	Maximum Crystal Drive Level	300	300	300	μW

## Recommended Crystal Specification for Thru-Hole Package

Parameter	Description	Range 1	Range 2	Range 3	Unit
Fmin	Minimum Frequency	8	14	24	MHz
Fmax	Maximum Frequency	14	24	32	MHz
R1	Motional Resistance (ESR)	90	50	30	Ω
C0	Shunt Capacitance	7	7	7	pF
CL	Parallel Load Capacitance	18	12	12	pF
DL(max)	Maximum Crystal Drive Level	1000	1000	1000	μW

### Test and Measurement Setup

Figure 4. Test and Measurement Setup

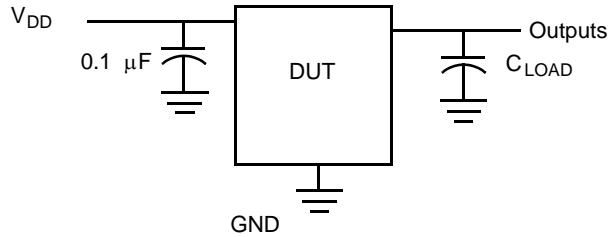

### Voltage and Timing Definitions

Figure 5. Duty Cycle Definition

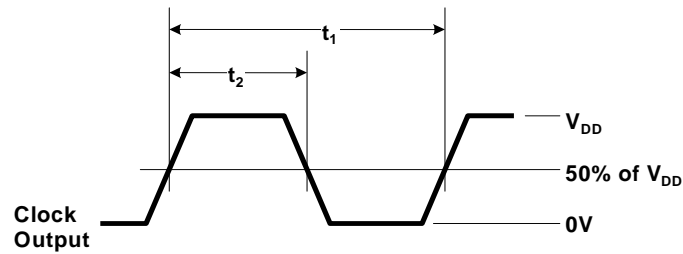
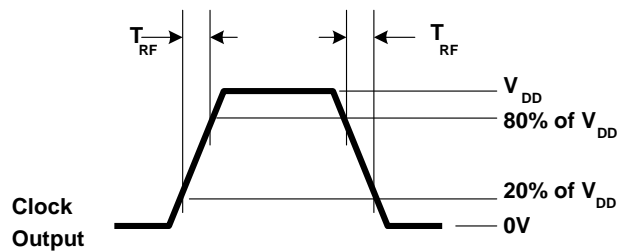

Figure 6. Rise Time =  $T_{RF}$  Fall Time =  $T_{RF}$





### Ordering Information

Part Number <sup>[3]</sup>	Type	VDD(V)	Production Flow
<b>Pb-free</b>			
CY25403SXC-xxx	8-pin SOIC	Supply Voltage: 2.5V, 3.0V or 3.3V	Commercial, 0°C to 70°C
CY25403SXC-xxxT	8-pin SOIC -Tape & Reel	Supply Voltage: 2.5V, 3.0V or 3.3V	Commercial, 0°C to 70°C
CY25483SXC-xxx	8-pin SOIC	Supply Voltage: 2.5V, 3.0V or 3.3V	Commercial, 0°C to 70°C
CY25483SXC-xxxT	8-pin SOIC -Tape & Reel	Supply Voltage: 2.5V, 3.0V or 3.3V	Commercial, 0°C to 70°C
CY25423SXC-xxx	8-pin SOIC	Supply Voltage: 1.8V	Commercial, 0°C to 70°C
CY25423SXC-xxxT	8-pin SOIC -Tape & Reel	Supply Voltage: 1.8V	Commercial, 0°C to 70°C
CY25403SXI-xxx	8-pin SOIC	Supply Voltage: 2.5V, 3.0V or 3.3V	Industrial, -40°C to +85°C
CY25403SXI-xxxT	8-pin SOIC -Tape & Reel	Supply Voltage: 2.5V, 3.0V or 3.3V	Industrial, -40°C to +85°C
CY25483SXI-xxx	8-pin SOIC	Supply Voltage: 2.5V, 3.0V or 3.3V	Industrial, -40°C to +85°C
CY25483SXI-xxxT	8-pin SOIC -Tape & Reel	Supply Voltage: 2.5V, 3.0V or 3.3V	Industrial, -40°C to +85°C
CY25423SXI-xxx	8-pin SOIC	Supply Voltage: 1.8V	Industrial, -40°C to +85°C
CY25423SXI-xxxT	8-pin SOIC -Tape & Reel	Supply Voltage: 1.8V	Industrial, -40°C to +85°C

### Package Drawing and Dimensions

Figure 7. 8-lead (150-Mil) SOIC S8

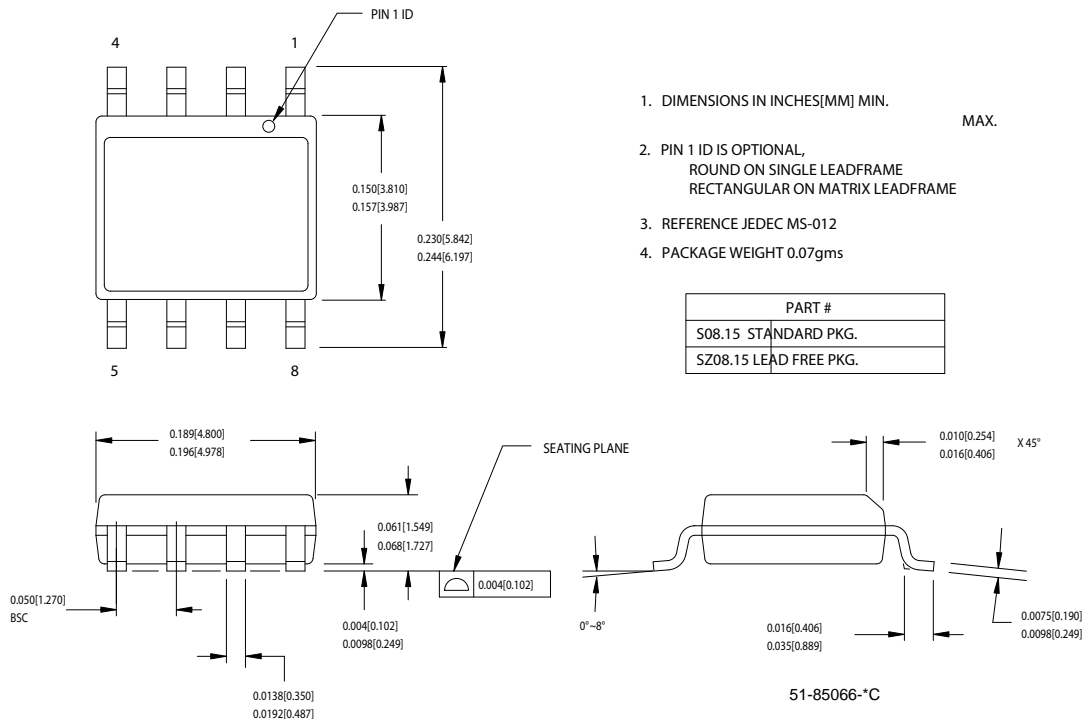

**Note**

3. xxx indicates Factory Programmable and are factory programmed configurations. For more details, contact your local Cypress FAE or Cypress Sales Representative.

## Document History Page

Document Title: CY25403/CY25423/CY25483 Three PLL Programmable Clock Generator with Spread Spectrum Document Number: 001-12564				
REV.	ECN NO.	Issue Date	Orig. of Change	Description of Change
**	690296	See ECN	RGL	New Data Sheet
*A	815788	See ECN	RGL	Minor Change: To post on web
*B	1428744	See ECN	RGL/AESA	Changed data sheet format to match generic part, CY2544/46 Added new device and specification for high ref. input voltage part, CY25483 Removed Preliminary from Title page Replaced CLK2 with REFOUT
*C	2748211	08/10/09	TSAI	Posting to external web.

© Cypress Semiconductor Corporation, 2007-2009. The information contained herein is subject to change without notice. Cypress Semiconductor Corporation assumes no responsibility for the use of any circuitry other than circuitry embodied in a Cypress product. Nor does it convey or imply any license under patent or other rights. Cypress products are not warranted nor intended to be used for medical, life support, life saving, critical control or safety applications, unless pursuant to an express written agreement with Cypress. Furthermore, Cypress does not authorize its products for use as critical components in life-support systems where a malfunction or failure may reasonably be expected to result in significant injury to the user. The inclusion of Cypress products in life-support systems application implies that the manufacturer assumes all risk of such use and in doing so indemnifies Cypress against all charges.

Any Source Code (software and/or firmware) is owned by Cypress Semiconductor Corporation (Cypress) and is protected by and subject to worldwide patent protection (United States and foreign), United States copyright laws and international treaty provisions. Cypress hereby grants to licensee a personal, non-exclusive, non-transferable license to copy, use, modify, create derivative works of, and compile the Cypress Source Code and derivative works for the sole purpose of creating custom software and or firmware in support of licensee product to be used only in conjunction with a Cypress integrated circuit as specified in the applicable agreement. Any reproduction, modification, translation, compilation, or representation of this Source Code except as specified above is prohibited without the express written permission of Cypress.

Disclaimer: CYPRESS MAKES NO WARRANTY OF ANY KIND, EXPRESS OR IMPLIED, WITH REGARD TO THIS MATERIAL, INCLUDING, BUT NOT LIMITED TO, THE IMPLIED WARRANTIES OF MERCHANTABILITY AND FITNESS FOR A PARTICULAR PURPOSE. Cypress reserves the right to make changes without further notice to the materials described herein. Cypress does not assume any liability arising out of the application or use of any product or circuit described herein. Cypress does not authorize its products for use as critical components in life-support systems where a malfunction or failure may reasonably be expected to result in significant injury to the user. The inclusion of Cypress' product in a life-support systems application implies that the manufacturer assumes all risk of such use and in doing so indemnifies Cypress against all charges.

Use may be limited by and subject to the applicable Cypress software license agreement.