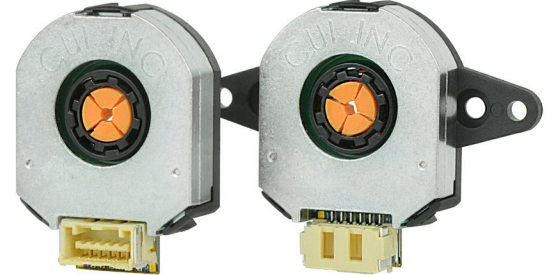

SERIES: AMT23 | **DESCRIPTION:** MODULAR ABSOLUTE ENCODER

FEATURES

- patented capacitive ASIC technology
- low power consumption
- 12 or 14-bit absolute position
- Synchronous Serial Interface
- configuration and firmware updates via AMT Viewpoint™ software
- digitally settable zero position
- compact modular package with locking hub for ease of installation
- radial and axial cable connections
- -40 ~ 105°C operating temperature

ELECTRICAL

parameter	conditions/description	min	typ	max	units
power supply	VDD	3.8	5	5.5	V
current consumption	with unloaded output		8		mA
output low level				0.4	V
output high level			3.3		V

ABSOLUTE POSITION CHARACTERISTICS

parameter	conditions/description	min	typ	max	units
resolution	12 or 14-bit				
accuracy			0.2		degrees
absolute zero position	configurable via AMT Viewpoint™ GUI				

MECHANICAL

parameter	conditions/description	min	typ	max	units
motor shaft length		9			mm
weight			15.7		g
axial play				±0.3	mm
rotational speed	12-bit position resolution			8,000	RPM
	14-bit position resolution			4,000	RPM

ENVIRONMENTAL

parameter	conditions/description	min	typ	max	units
operating temperature		-40		105	°C
humidity	non-condensing			85	%
vibration	10~500 Hz, 5 minute sweep, 2 hours on each XYZ			5	G
shock	3 pulses, 6 ms, 3 on each XYZ			200	G
RoHS	2011/65/EU				
REACH	EC 1907/2006				

SERIAL INTERFACE

parameter	conditions/description	min	typ	max	units
protocol	Serial Synchronous Interface (SSI)				
data rate			1	2	MHz
T_{CLK}	data shifted to output buffer			500	ns
T_{DOV}	time before data is valid			250	ns
T_{CS}	time between reads	1			μ s

TIMING CHARACTERISTICS

Figure 1

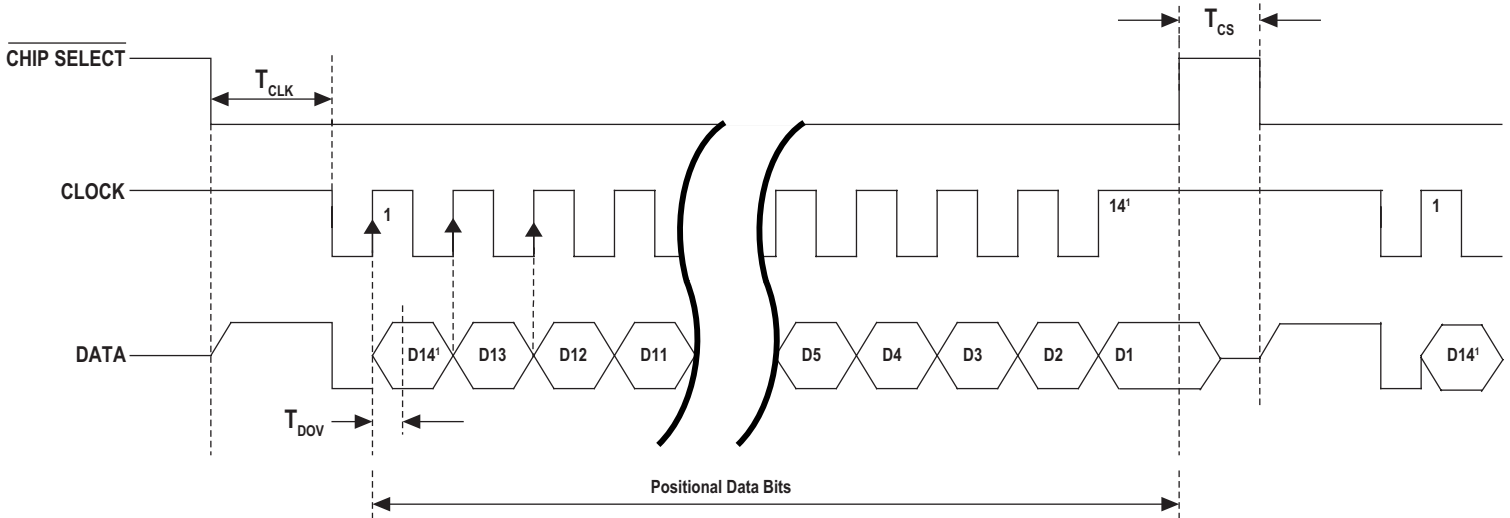

Notes: 1. For 12-bit resolution, clock line is toggled only 12 times.

PART NUMBER KEY

For customers that prefer a specific AMT23 configuration, please reference the custom configuration key below.

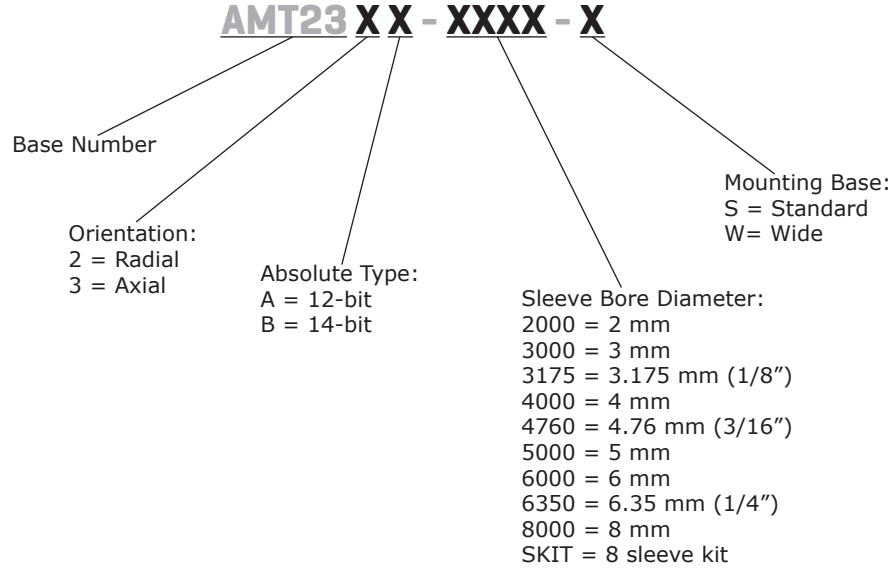

AMT23-V KITS









In order to provide maximum flexibility for our customers, the AMT23 series is provided in kit form standard. This allows the user to implement the encoder into a range of applications using one sku#, reducing engineering and inventory costs.





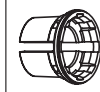

ORDERING GUIDE

AMT23XX-V

Orientation:
2 = Radial
3 = Axial

Absolute Type:
A = 12-bit
B = 14-bit

SLEEVES								
								
2mm	3mm	1/8 inch (3.175mm)	4mm	3/16 inch (4.76mm)	5mm	6mm	1/4 inch (6.35mm)	8mm
Light Sky Blue	Orange	Purple	Gray	Yellow	Green	Red	Snow	Blue

BASE	WIDE BASE	TOP COVER	SHAFT ADAPTER	TOOL A	TOOL C
					

ENCODER INTERFACE

PINOUT CONNECTOR	
#	Function
1	+5 V
2	DATA
3	CLOCK
4	GND
5 ¹	MODE
6	CHIP SELECT

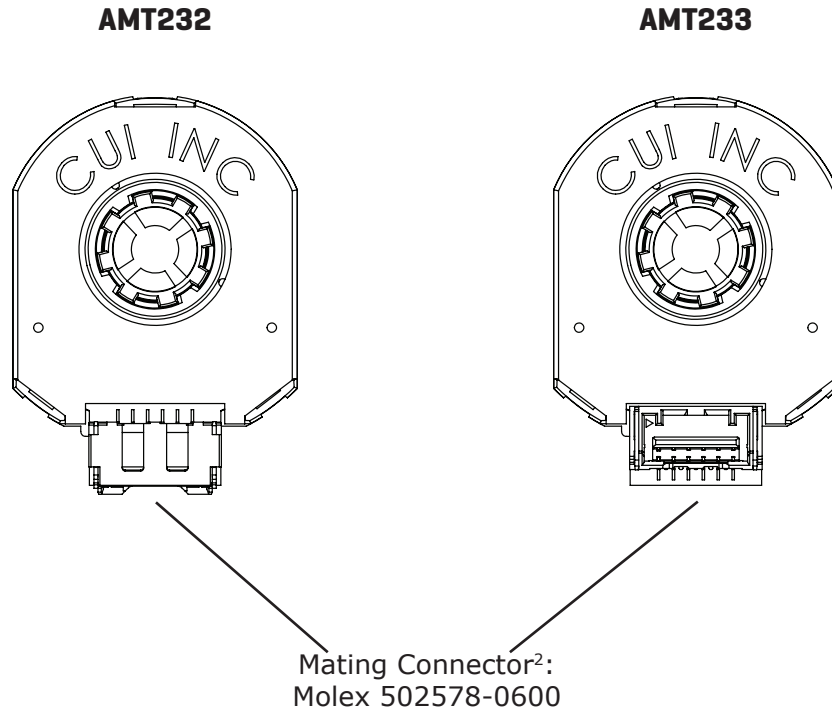

- Notes:
1. Mode pin is used by AMT Viewpoint™ for configuring the encoder and should be left open during normal operation.
 2. Compatible with prototype cable AMT-06C-1-036 and programming cable AMT-06C-1-036-USB.

MECHANICAL DRAWING

AMT232

units: mm

tolerance: ± 0.1

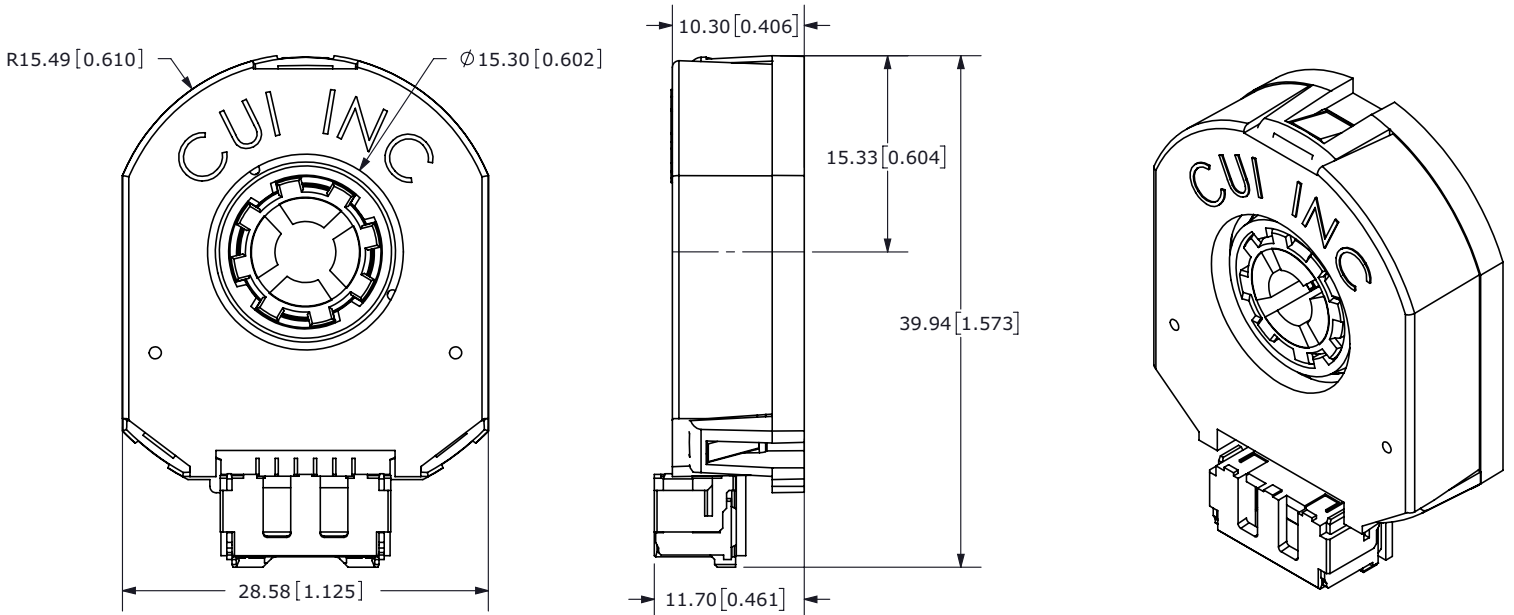

AMT233

units: mm

tolerance: ± 0.1

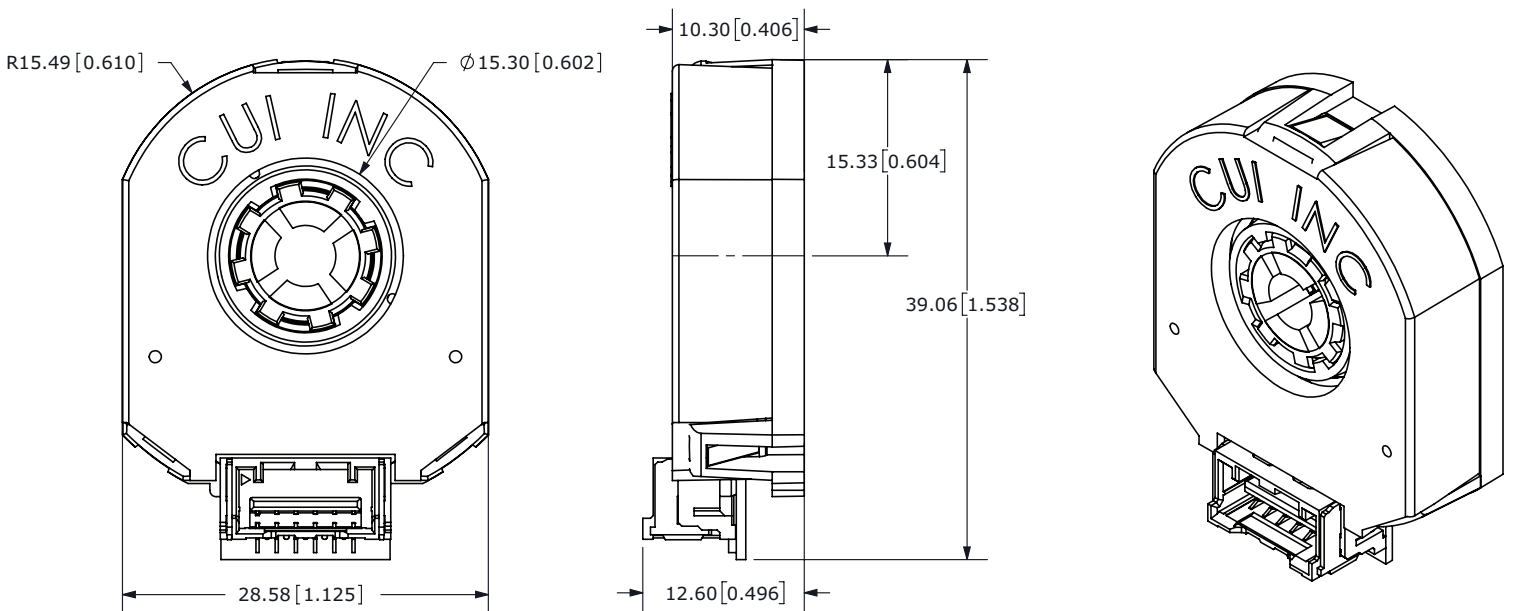

MECHANICAL DRAWING (CONTINUED)

MOUNTING HOLE PATTERNS

STANDARD BASE

units: mm[inch]
tolerance: ± 0.1

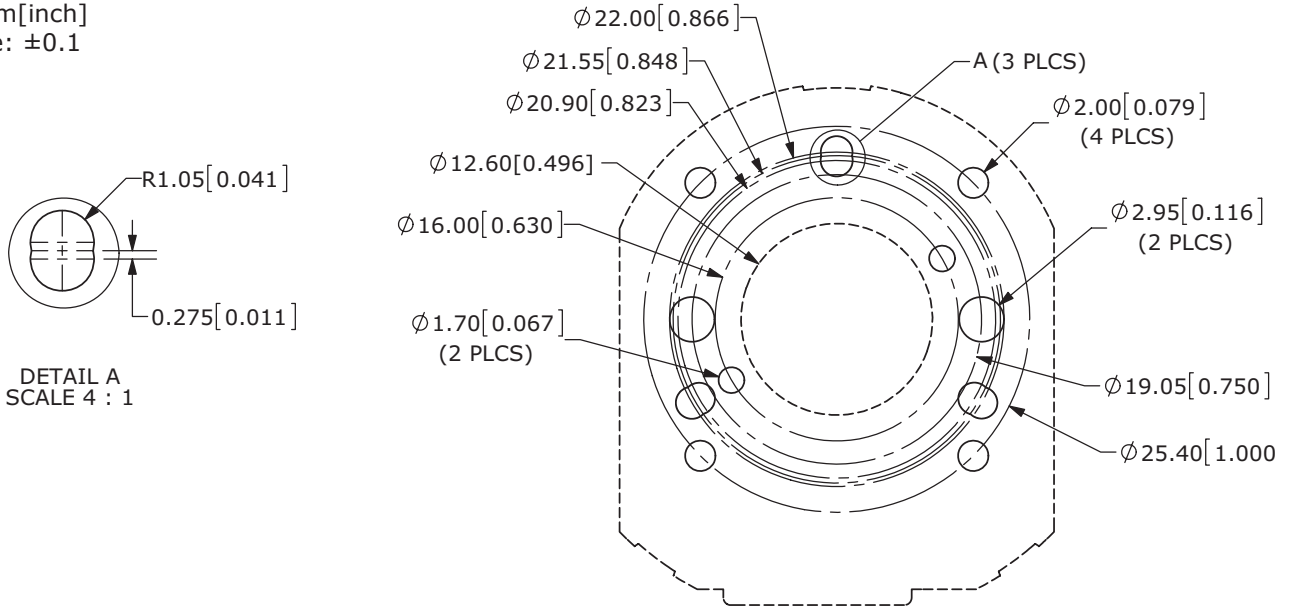

WIDE BASE

units: mm[inch]
tolerance: ± 0.1

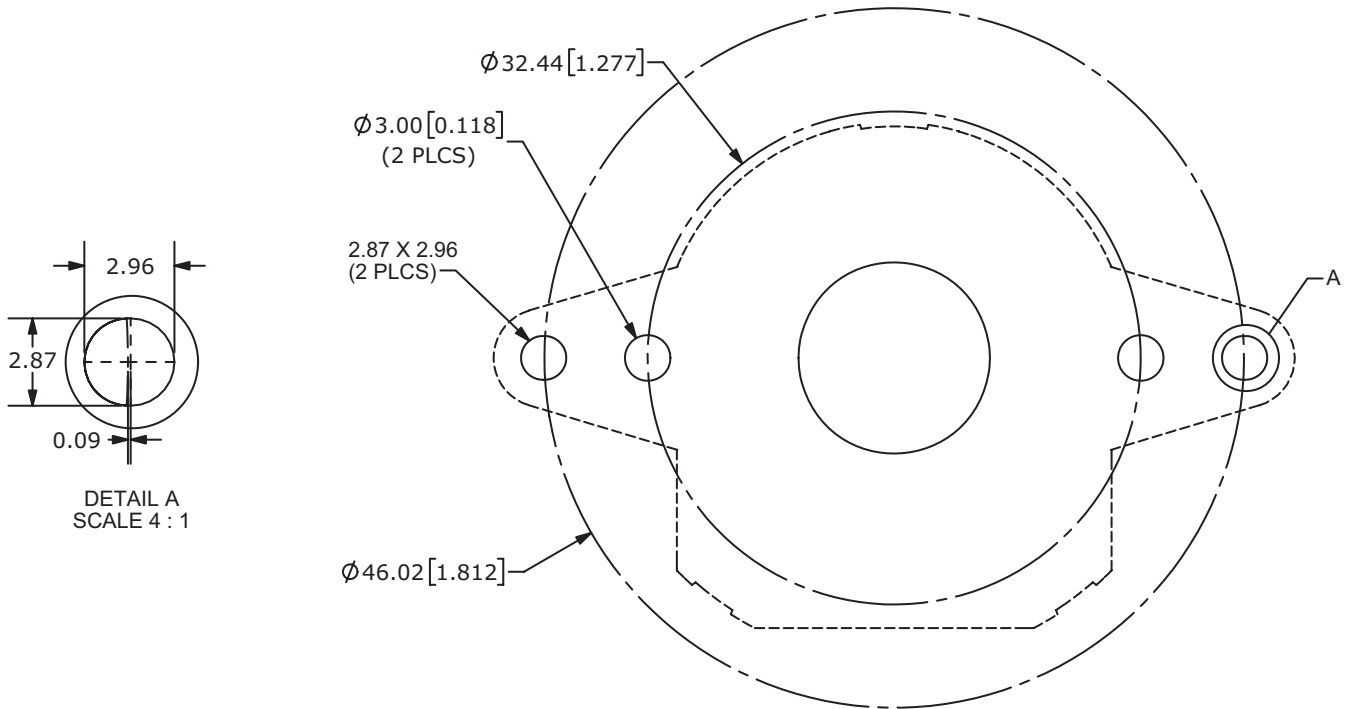

ASSEMBLY PROCEDURE

STEP 1

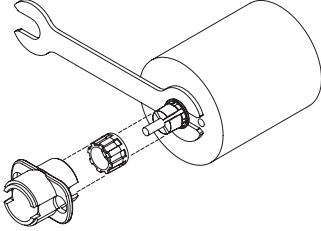

1. Insert Tool A as a spacer that defines the distance to the mounting surface.
2. Slide appropriate sized Sleeve over shaft all the way down to Tool A.
3. Slide Shaft Adaptor over Sleeve.
4. Use Tool C to press Shaft Adaptor over Sleeve [ensure Shaft Adaptor and Tool C spline alignment] until flush with Tool A.

STEP 2

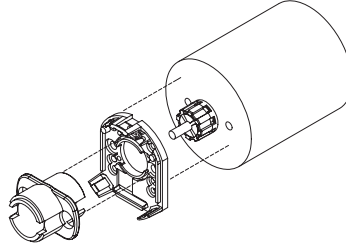

1. Remove Tools A and C.
2. Place Base on motor, with Tool C used as a centering tool.

STEP 3

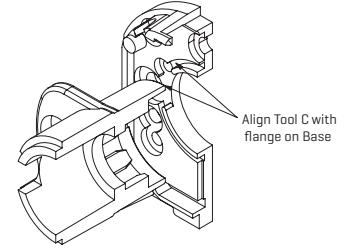

1. Align Tool C with flange on Base.
2. Slide Base and Tool C onto motor, centering onto the Shaft Adaptor.

STEP 4

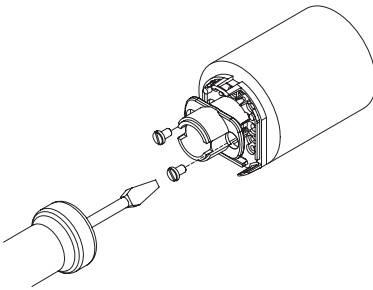

1. Fasten the Base on the motor (Tool C may need to be rotated to allow for some mounting configurations).
2. Remove Tool C.

STEP 5

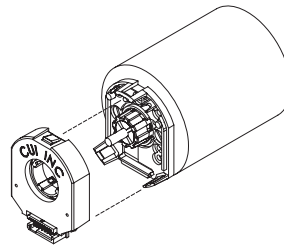

1. Snap the Top Cover onto the Base, carefully observing that the teeth of the Shaft Adaptor align with the grooves in the hub. *
- * We recommend no more than three cycles of mounting and removal of the AMT top cover base. Multiple cycles of mounting and removing the top cover can cause base fatigue over time and affect encoder performance.

STEP 6

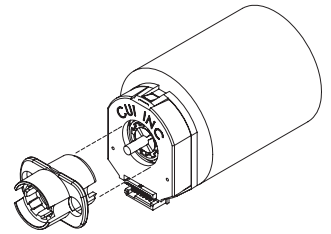

1. Make sure the snaps are fully engaged by pressing on the Hub with the reverse side of Tool C.
2. When assembly is finished, the Shaft Adaptor, Sleeve and Rotor Hub should all be flush with the Motor Shaft rotating freely.

REVISION HISTORY

rev.	description	date
1.0	initial release	12/11/2017

The revision history provided is for informational purposes only and is believed to be accurate.



CUI INC[®]

Headquarters
20050 SW 112th Ave.
Tualatin, OR 97062
800.275.4899

Fax 503.612.2383
cui.com
techsupport@cui.com

CUI offers a one (1) year limited warranty. Complete warranty information is listed on our website.

CUI reserves the right to make changes to the product at any time without notice. Information provided by CUI is believed to be accurate and reliable. However, no responsibility is assumed by CUI for its use, nor for any infringements of patents or other rights of third parties which may result from its use.

CUI products are not authorized or warranted for use as critical components in equipment that requires an extremely high level of reliability. A critical component is any component of a life support device or system whose failure to perform can be reasonably expected to cause the failure of the life support device or system, or to affect its safety or effectiveness.