

METAL CASE, CASE-MOUNTED SEMICONDUCTORS

HP1 Series for Single TO-3 or Stud Mount Devices

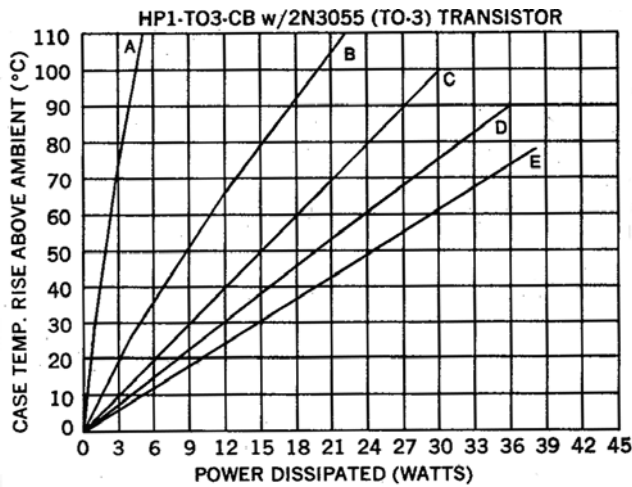
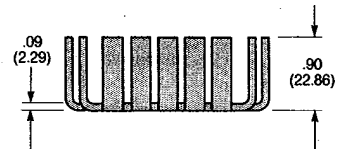
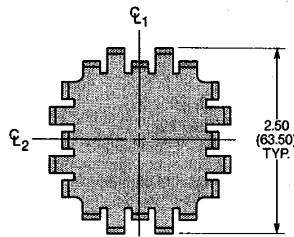

DESCRIPTION OF CURVES

- A. N.C. Horiz. Device Only Mounted to G-10.
- A. N.C. Horiz. & Vert. With Dissipator.
- B. 200 RPM w/Diss.
- C. 500 RPM w/Diss.
- E. 1000 RPM w/Diss.

- Thermal Resistance Case to Sink is 0.1-0.3 °C/W w/Joint Compound.
- Derate 1.0 °C/watt for unplated part in natural convection only.

Ordering Information

| IERC PART NO. | | | Semiconductor Accommodated | Hole patt. Ref. No. (see pg. 1-28) | Max. Weight (Grams) |
|---------------|-----------------------|--------------------|----------------------------|------------------------------------|---------------------|
| Unplated | Comm'l. Black Anodize | Mil. Black Anodize | | | |
| HP1-000-U | HP1-000-CB | HP1-000-B | Undrilled | -- | 35.0 |
| HP1-TO3-U | HP1-TO3-CB | HP1-TO3-B | TO-3 | 16 | 35.0 |
| HP1-TO3-33U | HP1-TO3-33CB | HP1-TO3-33B | TO-3 IC | 17 | 35.0 |
| HP1-TO3-44U | HP1-TO3-44CB | HP1-TO3-44B | TO-3 panel mount | 31 | 35.0 |
| HP1-436-U | HP1-436-CB | HP1-436-B | TO-3 (4-pin) | 18 | 35.0 |
| HP1-T06-U | HP1-T06-CB | HP1-T06-B | TO-6, TO-36 | 19 | 35.0 |
| HP1-TO15-U | HP1-TO15-CB | HP1-TO15-B | TO-15, DO-5 | 23 | 35.0 |
| HP1-420-U | HP1-420-CB | HP1-420-B | Universal | 27 | 35.0 |

HP1 Series for Single TO-66 Outline

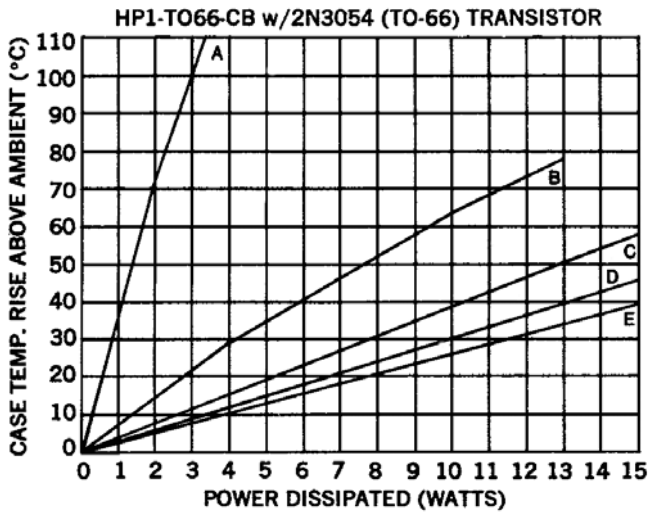
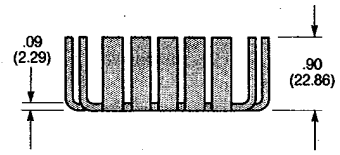
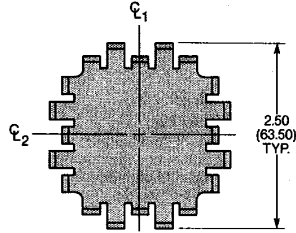

DESCRIPTION OF CURVES

- B. N.C. Horiz. Device Only Mounted to G-10.
- D. N.C. Horiz. & Vert. With Dissipator.
- E. 200 RPM w/Diss.
- F. 500 RPM w/Diss.
- E. 1000 RPM w/Diss.

- Thermal Resistance Case to Sink is 0.5-0.7 °C/W w/Joint Compound.
- Derate 1.0 °C/watt for unplated part in natural convection only.

Ordering Information

| Unplated | IERC PART NO. | | Semiconductor Accommodated | Hole patt. Ref. No. (see pg. 1-28) | Max. Weight (Grams) |
|--------------|-----------------------|--------------------|----------------------------|------------------------------------|---------------------|
| | Comm'l. Black Anodize | Mil. Black Anodize | | | |
| HP1-TO66-U | HP1-TO66-CB | HP1-TO66-B | TO-66 | 24 | 35.0 |
| HP1-TO66-35U | HP1-TO66-35CB | HP1-TO66-35B | TO-66 IC | 25 | 35.0 |
| HP1-TO66-49U | HP1-TO66-49CB | HP1-TO66-49B | TO-66 IC (Socket) | 26 | 35.0 |

HP1 Series for Dual TO-66 Outline

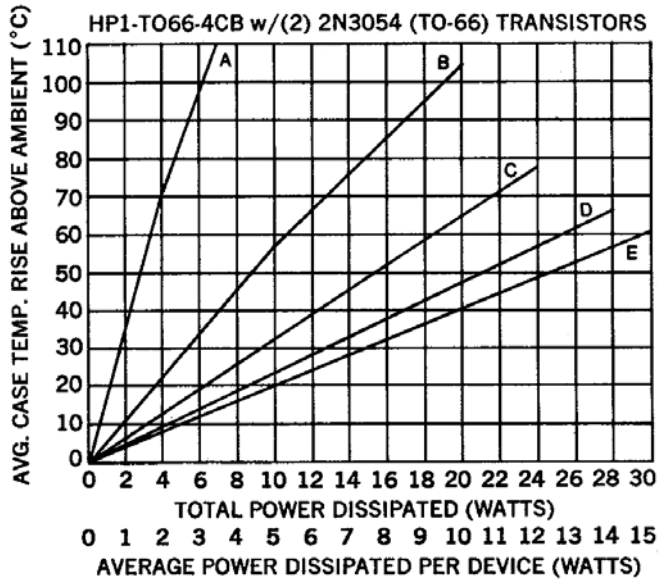
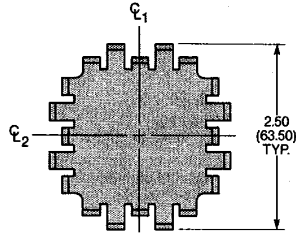

DESCRIPTION OF CURVES

- C. N.C. Horiz. Device Only Mounted to G-10.
- G. N.C. Horiz. & Vert. With Dissipator.
- H. 200 RPM w/Diss.
- I. 500 RPM w/Diss.
- E. 1000 RPM w/Diss.

- Thermal Resistance Case to Sink is 0.5-0.7 °C/W w/Joint Compound.
- Derate 2.0 °C/watt per device for unplated part in natural convection only.
- Case Temperatures Match Within 2°C at equivalent power levels.

Ordering Information

| IERC PART NO. | | | Semiconductor Accommodated | Hole patt. Ref. No. (see pg. 1-30) | Max. Weight (Grams) |
|---------------|-----------------------|--------------------|----------------------------|------------------------------------|---------------------|
| Unplated | Comm'l. Black Anodize | Mil. Black Anodize | | | |
| HP1-TO66-4U | HP1-TO66-4CB | HP1-TO66-4B | Two TO-66s | 32 | 35.0 |
| HP1-TO66-36U | HP1-TO66-36CB | HP1-TO66-36B | Two TO-66 lcs | 34 | 35.0 |

HP1 Series for Three TO-66 Outline

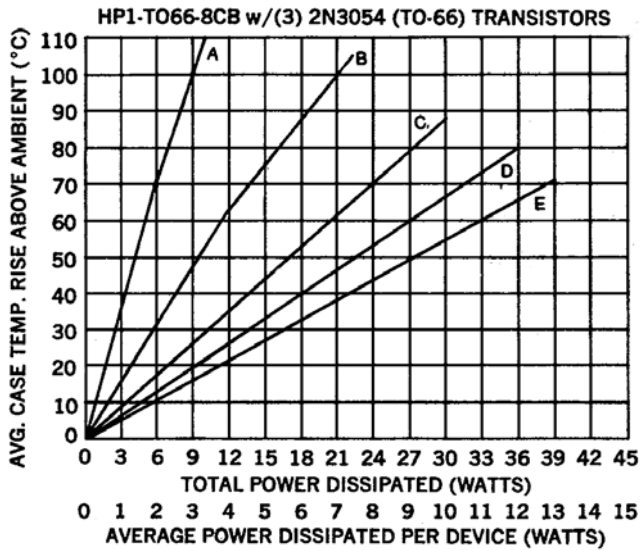
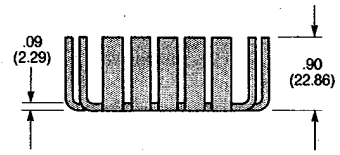
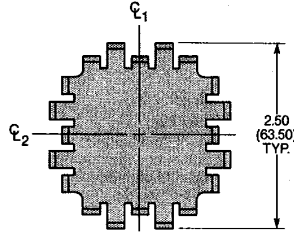

DESCRIPTION OF CURVES

- D. N.C. Horiz. Device Only Mounted to G-10.
- J. N.C. Horiz. & Vert. With Dissipator.
- K. 200 RPM w/Diss.
- L. 500 RPM w/Diss.
- E. 1000 RPM w/Diss.

- Thermal Resistance Case to Sink is 0.5-0.7 °C/W w/Joint Compound.
- Derate 3.0 °C/watt per device for unplated part in natural convection only.
- Case Temperatures Match Within 2°C at equivalent power levels in natural convection.

Ordering Information

| IERC PART NO. | | | Semiconductor Accommodated | Hole patt. Ref. No. (see pg. 1-30) | Max. Weight (Grams) |
|---------------|-----------------------|--------------------|----------------------------|------------------------------------|---------------------|
| Unplated | Comm'l. Black Anodize | Mil. Black Anodize | | | |
| HP1-TO66-8U | HP1-TO66-8CB | HP1-TO66-8B | Two TO-66s | 33 | 35.0 |
| HP1-TO66-39U | HP1-TO66-39CB | HP1-TO66-39B | Two TO-66 lcs | 35 | 35.0 |

HOLE PATTERNS

16. Hole pattern no. 1 accommodates T0-3s. Available in UP, UP1, UP2, HP1, and HP3 series heat dissipators.

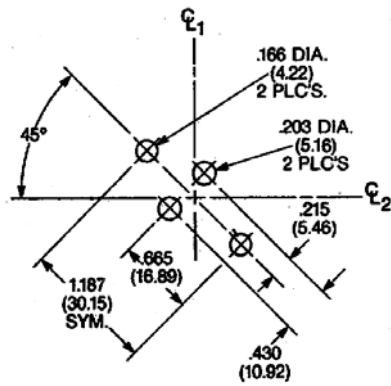

17. Hole pattern no. 202 accommodates T0-3 ICs. Available in UP, UP1, UP2, HP1, and HP3 series heat dissipators.

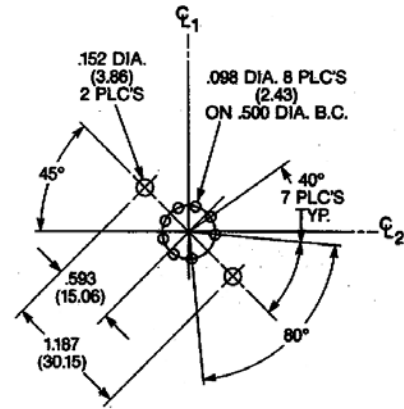

18. Hole pattern no. 436 accommodates t0-3s (4-pin). Available in UP, UP1, UP2, HP1, and HP3 series heat dissipators.

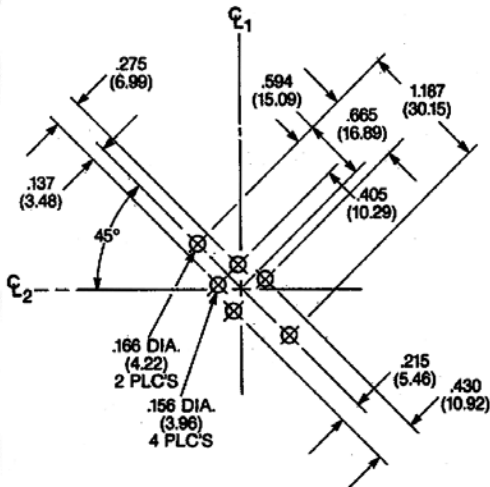

19. Hole pattern no. 2 accommodates T0-6s or T0-36s. Available in UP, UP1, UP2, HP1, and HP3 series heat dissipators.

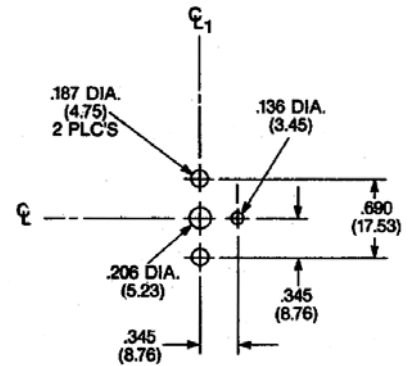

23. Hole pattern no. 3 accommodates TO-15s, DO-5s and other 1/4" stud mount devices. Available in UP, UP1, UP2, HP1, and HP3 series heat dissipators.

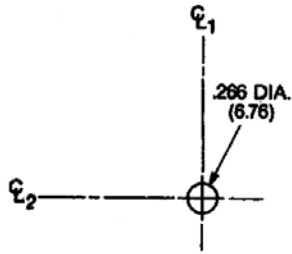

24. Hole pattern no. 114 accommodates TO-66s. Available in UP, UP1, UP2, HP1, and HP3 series heat dissipators.

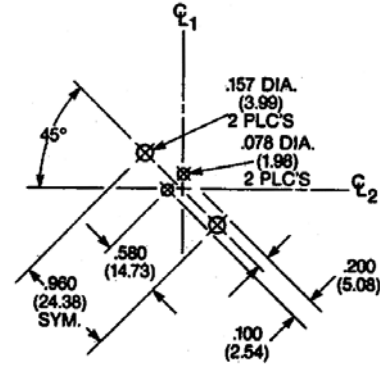

25. Hole pattern no. 199 accommodates TO-66 ICs. Available in UP, UP1, UP2, HP1, and HP3 series heat dissipators.

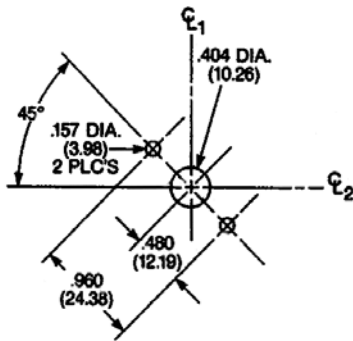

26. Hole pattern no. 226 accommodates TO-66 ICs (socket). Available in UP, UP1, UP2, HP1, and HP3 series heat dissipators.

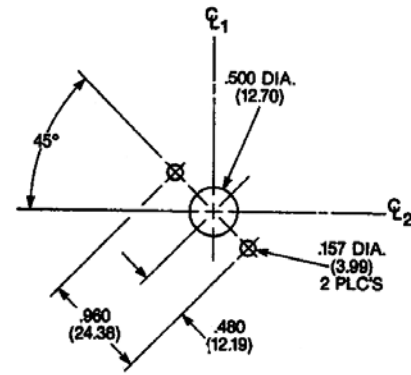

31. Hole pattern no. 213 accommodates one TO-3 (panel mounted). Available in HP1 and HP3 series heat dissipators only.

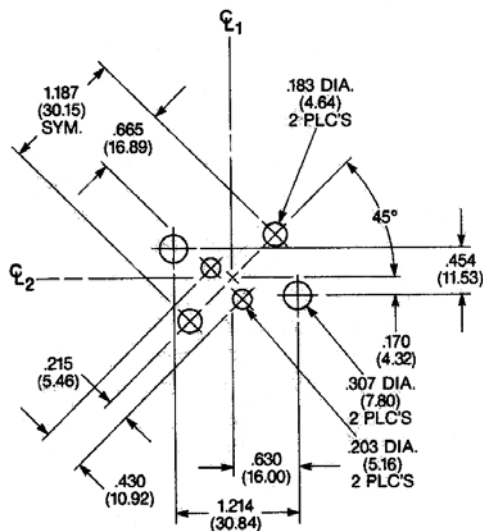

32. Hole pattern no. 150 accommodates two TO-66s. Available in HP1 and HP3 series heat dissipators only.

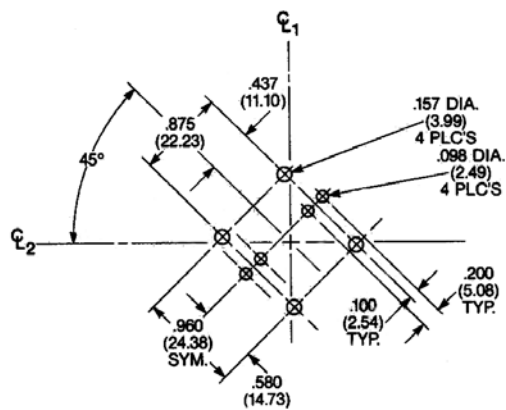

33. Hole pattern no. 185 accommodates three TO-66s.
Available in HP1 and HP3 series heat dissipators only.

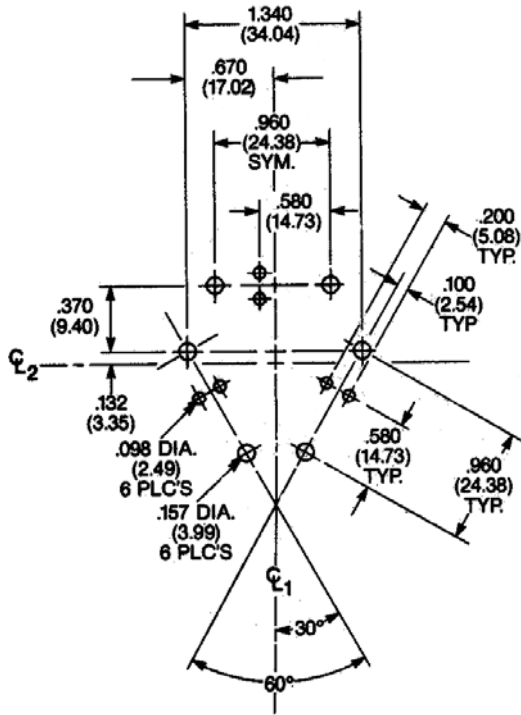

34. Hole pattern no. 201 accommodates two TO-66s ICs.
Available in HP1 and HP3 series heat dissipators only.

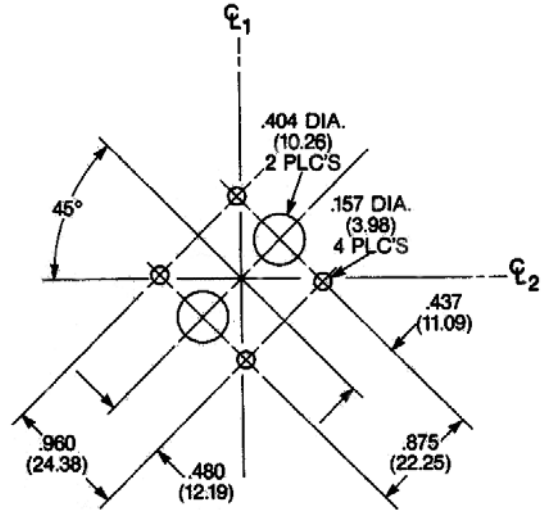

35. Hole pattern no. 203 accommodates three TO-66 ICs.
Available in HP1 and HP3 series heat dissipators only.

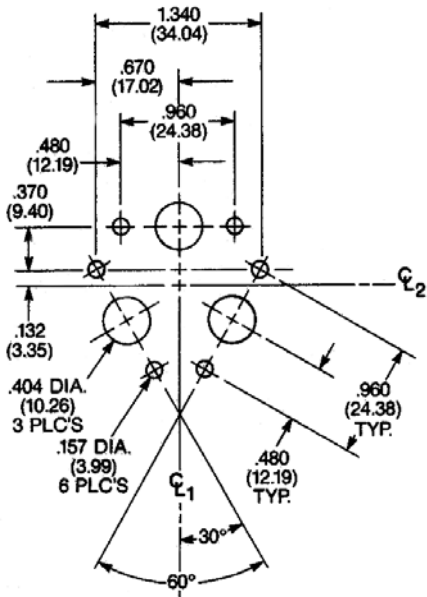

27. Hole pattern no. 420 (Universal) accommodates TO-3s, TO-66s, T0-126s, T0-127s, or T0-220s.
Available in UP, UP1, UP2, HP1, and HP3 series heat dissipators.

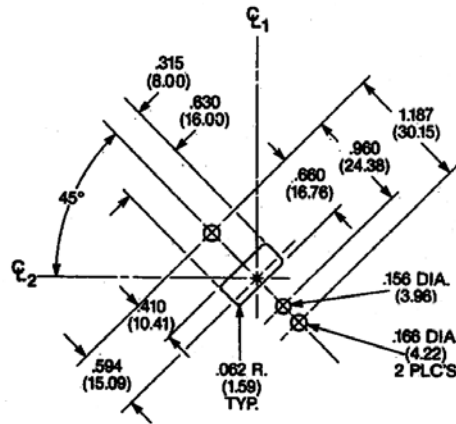

CTS IERC, Heat Sinks and Thermal Management Solutions

413 North Moss Street, Burbank, California 91502 Tel: (818) 842-7277 Fax: (818) 848-8872