



**Muffin XL AC - MX77A2 - 028989**  
 (Family) (Model) (Part Number)

### Electrical Specifications

Rated Voltage:	230 VAC
AC Frequency:	60 Hz
Power Supply:	15.0 Watts
Line Current:	0.08 Amps
Locked Rotor Current	0.12 Amps
Nominal Speed:	2940 RPM



### Mechanical Specifications

Dimensions:	4.72in x 1.50in
Weight	21.0 oz
Max Airflow @ 0 in H <sub>2</sub> O	105.0 CFM
Max Pressure @ 0 CFM	0.223 in H <sub>2</sub> O
Noise	47.6 dBA

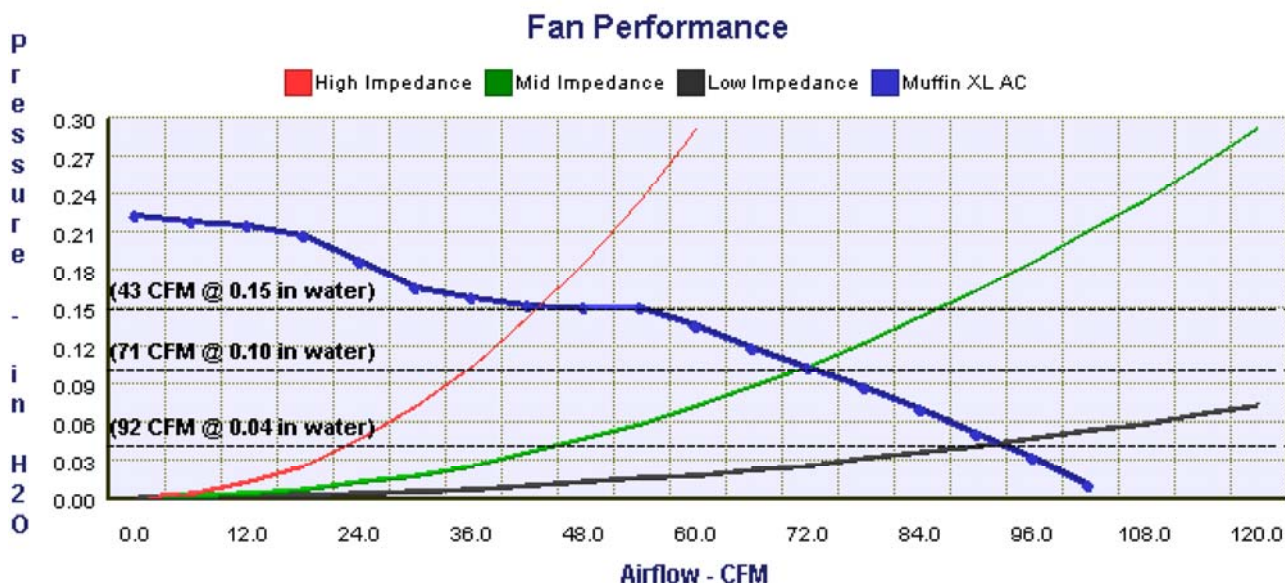

Comair Rotron, Inc.  
 Phone: 619.651.2000  
 sales@comairrotron.com

Comair Rotron Europe, Ltd.  
 Phone: +44.1527.520525  
 saleseurope@comairrotron.com

Comair Rotron Fan Company Ltd.  
 Phone: +86.21.52260581  
 salesasia@comairrotron.com

Print Date: Wednesday, November 10, 2010 at 09:56:07 - AC Fan Datasheet - Web Version 1.0 Rev. A



## Mechanical Drawing

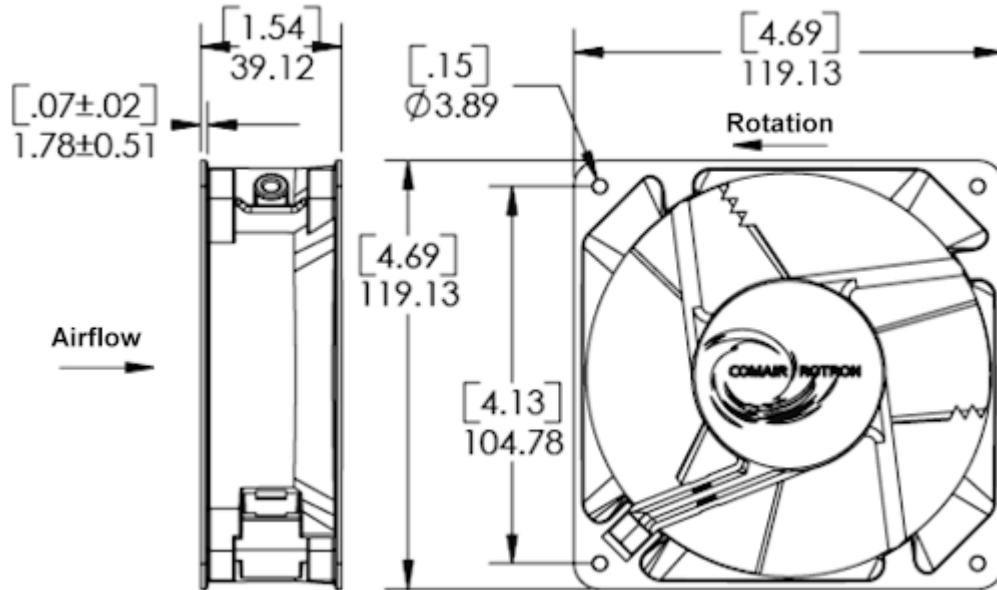

## Options

Part Number	Model Number	Bearing Type	Fan Rotation	Termination	In-Stock <small>(Click 'Yes' for current stock)</small>
<input type="radio"/> 028793	MX77B3	Ball	Reverse	0.120 Terminals	No
<input type="radio"/> 028781	MX77A1	Sleeve	Normal	0.120 Terminals	No
<input checked="" type="radio"/> 028989	MX77A2	Sleeve	Normal	Leads	No
<input type="radio"/> 028792	MX77A3	Sleeve	Reverse	0.120 Terminals	No

## Accessories (Click on part number for detailed drawing.)

428056  
Plug and Cord

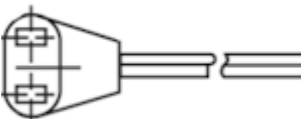

550440  
Plug and Cord

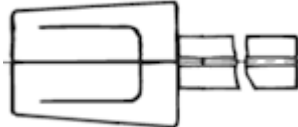

550113  
Mounting Clip



551590  
Filter Assembly  
Mounting Bracket  
Filter Frame  
Filter Element  
Fan  
Venturi Edge

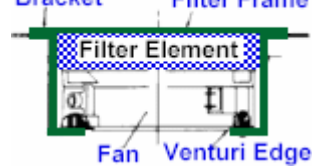

554148  
Filter Guard Assembly

552934  
Finger Guard

476042  
Finger Guard

550481  
Finger Guard

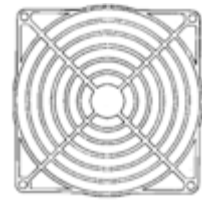
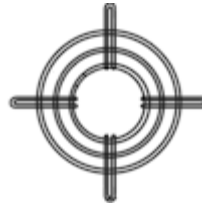
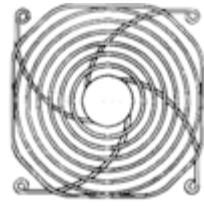
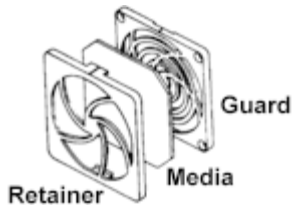

551147  
Finger Guard



**Comair Rotron, Inc.**  
Phone: 619.651.2000  
sales@comairrotron.com

**Comair Rotron Europe, Ltd.**  
Phone: +44.1527.520525  
saleseurope@comairrotron.com

**Comair Rotron Fan Company Ltd.**  
Phone: +86.21.52260581  
salesasia@comairrotron.com

Print Date: Wednesday, November 10, 2010 at 09:56:07 - AC Fan Datasheet - Web Version 1.0 Rev. A