

SPECIFICATIONS

RoHS

Model Number: SU2B1
Part Number: 19028268A

Version: 08
Dec 29, 2017



Mechanical Drawing:

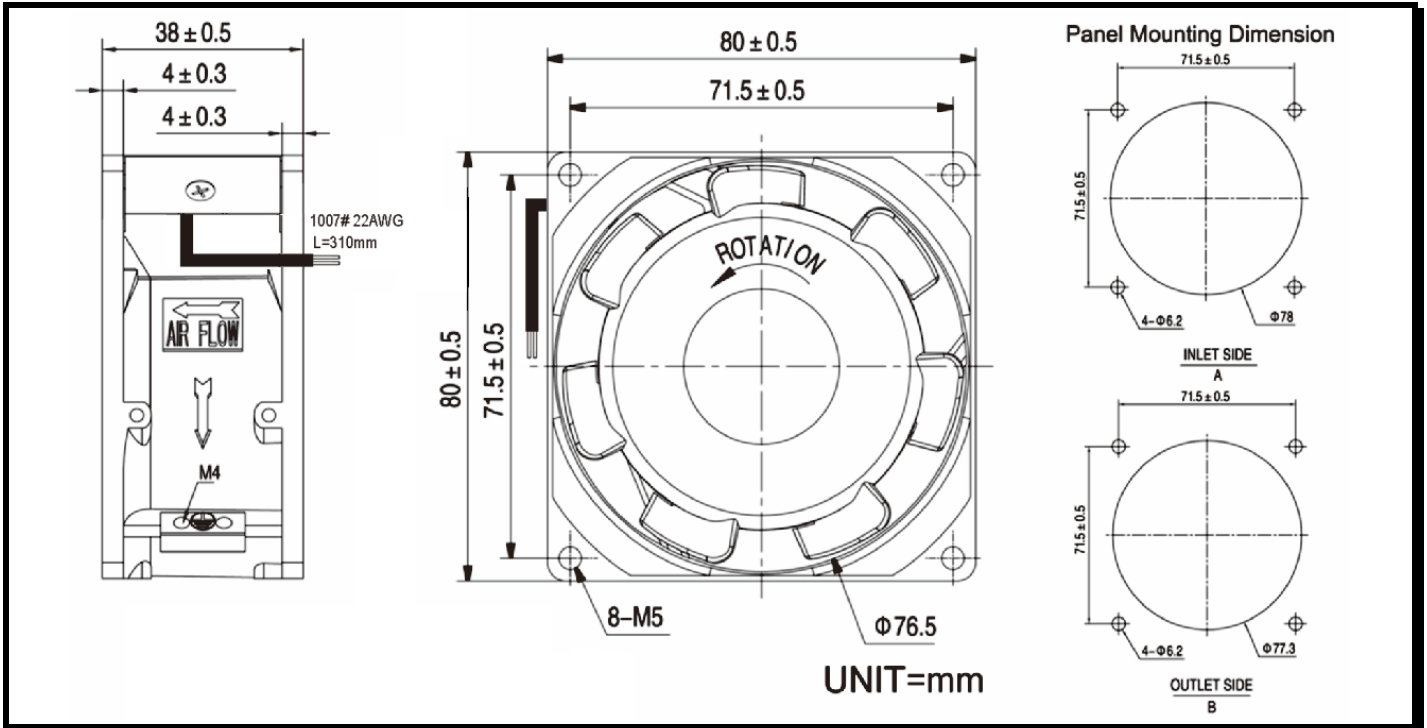

Motor:

Normal Voltage = 115 VAC
Operating Voltage Range = 99~121VAC
Operating Frequency = 50/60Hz
Rated Current = 0.14/0.13A
Input Power = 15/13Watt
Average Speed = 2380/2800RPM
Bearings = Ball
Airflow = 24/31CFM
(Measuring at zero static pressure)
Static Pressure = 0.13/0.17'' H₂O
(Measuring at zero air flow)
Noise Level = 30/32 dB(A)
Net Weight = 260 gram.

Construction:

Venturi: High quality magnesium alloy die-casting frame with ED coating and powder coating, Black.
Propeller: Magnesium alloy with ED coating, Black

Life Expectancy:

This fan is designed for continuous duty life of 62,000 hours at 70°C

Additional Features:

Insulation Resistance: 100MΩ or more at 500 V megger.
Dielectric strength: 2 seconds at 1800 VAC/ 50-60 Hz.
Thermal Shock: Test per MIL-STD-202F, method 107G, condition D.
Operating Temperature: -10°C to 70°C
Storage Temperature: -40°C to 85°C

Termination:

See Mechanical Drawing.
Lead wire connection suit with 22AWG 1007#
Wire length=310 ± 25.4mm

Agency Approvals:

UL, CUL, CE

PQ Curve:

